



ISESER2023



INTERNATIONAL SYMPOSIUM FOR  
**ENVIRONMENTAL  
SCIENCE AND  
ENGINEERING  
RESEARCH**  
Uluslararası Çevre  
Bilimleri ve Mühendislik  
Araştırmaları Sempozyumu  
**18-21 October Ekim 2023**

# PROCEEDING BOOK





neupress.org



pressneu

**Necmettin Erbakan Üniversitesi Yayınları:**

**Necmettin Erbakan University Press:**

**PROCEEDING BOOK of INTERNATIONAL SYMPOSIUM FOR  
ENVIRONMENTAL SCIENCE AND ENGINEERING RESEARCH (ISESER2023)**

**Genel Yayın Yönetmeni/Editor in Chief**

Dr. Öğr. Üyesi Fatih KALECİ

**Editörler/Editors**

Dr. Şükrü DURSUN

Dr. Fatma KUNT

Dr. Zeynep Cansu AYTURAN

**Tasarım/Desing**

Büşra UYAR

Muhammed Sami TEKİN

Enes Malik YALÇIN

**E-ISBN**

978-625-6802-87-2

**Baskı/Printing**

Necmettin Erbakan University Press (NEU PRESS)

Yaka Mah. Yeni Meram Cad. Kasım Halife Sok. B Blok

No: 11 Meram / KONYA / TÜRKİYE

0332 221 0 575 - www.neupress.org

**Sertifika No: 48888**

**NEU PRESS 1. Baskı, Konya/TÜRKİYE**

Aralık 2023, vii + 281 sf., 21x29,7 cm



Lisans Türü | OA License: CC BY 4.0

Erişim | Access: neupress.org

Copyright 2023

*This book is published under a CC BY license, which means that you can copy, redistribute, remix, transform, and build upon the content for any purpose, even commercially, as long as you give appropriate credit, provide a link to the license, indicate if changes were made, and do not impose additional terms or conditions on others that prohibit them from exercising the rights granted by that license, including any effective technological measures.*



**ISESER**

**PROCEEDING BOOK**  
of  
**INTERNATIONAL SYMPOSIUM FOR ENVIRONMENTAL  
SCIENCE AND ENGINEERING RESEARCH  
(ISESER2023)**

**Oct 18-21, 2023 KONYA**

**Editors:**

**Şükrü Dursun, Engineering & Natural Sciences Faculty, Konya Technical University, Konya,  
Türkiye**

**Fatma Kunt, Engineering Faculty, Necmettin Erbakan University, Konya, Türkiye  
Zeynep Cansu Ayturan, Engineering & Natural Sciences Faculty, Konya Technical University,  
Konya, Türkiye**

**November 2023, Konya, Türkiye**

## SPONSORS AND PARTNERS

### Sponsors



### Journals



### *Design and Technical Support:*

Merve Acar, Necmettin Erbakan University, Graphic Design Unit, Konya, Türkiye  
Yasin Akın Ayturan, Karatay University, Engineering Faculty, Konya  
Zeynep Cansu Ayturan, Konya Technical University, Engineering Faculty, Konya

### *Publisher:*

Electronic printing by <https://iseser.com>

### *Disclaimer:*

This book contains paper abstracts that have received the Scientific Committee approval. Authors are responsible for the content and accuracy.

Information in the ISESER 2023 Abstract Book is subject to change without notice. No part of this book may be reproduced or transmitted in any form or any means, electronic or mechanical, for any purpose, without the express written permission of International Scientific Council except permission of ISESER 2023 Organisation Committee.

**Note: All Rights Reserved. Copyright © ISESER, JIEAS, IJEPEM and UCBAD**

## INTERNATIONAL SYMPOSIUM FOR ENVIRONMENTAL SCIENCE AND ENGINEERING RESEARCH (ISESER)

Phone : +90 332 2051559  
: +90 536 5954591  
Fax : +90 332 2410635  
E-Mail : [iseser@iseser.com](mailto:iseser@iseser.com)  
[sdursun@ktun.edu.tr](mailto:sdursun@ktun.edu.tr)  
URL : <https://iseser.com>

## **Honorary Committee**

Prof. Dr. Cem Zorlu, Rector of the Necmettin Erbakan University, Konya, Türkiye  
Prof. Dr. Hüseyin Deveci Vice Rector Konya Technical University, Konya, Türkiye  
Prof. Dr. Semih Ekercin, Dean of Engineering Faculty, Necmettin Erbakan University, Konya, Türkiye  
Prof. Ts. Dr. Che Mohd Ruzaidi Bin Ghazali, Dean Faculty of Ocean Engineering Technology,  
University Malaysia Terengganu, Terengganu, MALAYSIA

## **Scientific Committee**

Abdelbasset Bessadok-Jemai, Institut Supérieur des Sciences Appliquées et de Technologie de Gabès,  
Tunusia  
Abdel-Moneim M. Galal Shaalan, Science Faculty, Taibah University, Saudi Arabia  
Abdul Razaque Sahito, Engineering & Technology Faculty, Mehran University, Pakistan  
Alaa Motar Shayia Tor, Atmospheric Sciences Dept., College of Science, Mustansiriyah University,  
Baghdad, Iraq  
Ali Tor, Engineering and Architecture Faculty, Necmettin Erbakan University, Konya, Türkiye  
Altin Dorri, Polytechnic University of Tirana, Albania  
Amjad Shraim, Chemistry & Earth Sciences Department, Qatar University, Qatar  
Bahriye Gülgün, Agriculture Faculty, Ege University, İzmir  
Bahtiyar Öztürk, Engineering Faculty, Ondokuz Mayıs University, Samsun  
Cezar Kongoli, National Oceanic and Atmospheric Administration, University of Maryland, USA  
Chedly Tizaoui, Chemistry & Environment Sciences Department, Nottingham University, United  
Kingdom  
Çiğdem Çiftçi, Engineering and Architecture Faculty, Necmettin Erbakan University, Konya, Türkiye  
Delia Teresa Sponza, Engineering Faculty, Dokuz Eylül University, İzmir  
Etleva Dobjani, University Barleti, Tirana, Albania  
Fernando Sa Neves Santos, Instituto Politécnico Da Guarda University, Portugal  
Genta Rexha, Albanian University, Tirana, Albania  
Hab. Boguslaw Buszewsk, Nicolaus Copernicus University, Chemistry Faculty, Poland  
Hamiyet Şahin Kol, Faculty Of Engineering, Karabuk University, Karabuk, Türkiye  
Hasan Küçükkendirci, Faculty Of Medicine, Necmettin Erbakan University, Konya, Türkiye  
Hisham M. Alidrisi, King Abdulaziz University, Saudi Arabia  
Houcine Benaïssa, Science Faculty, Tlemcen University, Algeria  
Hüseyin Toros, İstanbul Teknik University, İstanbul, Türkiye  
Hysen Mankolli, Editor of IJEES, Health and Environment Association, Illinois, USA  
Indumathi M Nambi, Indian Institute of Technology Madras, India  
Ir. Raf Dewıl, Leuven Catholic University, Belgium  
Irena Baranowska, Silesian Technical University, Poland  
Jacek D. Czerwinski, Lublin Technology University, Poland  
Juliana Jalaludin, Universiti Putra Malaysia, Serdang, Malaysia  
Laura Shumka, University Barleti, Tirana, Albania  
Leah Moore, Applied Science Faculty, Canberra University, Australia  
Lirika Kupe, Agricultural University of Tirana, Albania  
Lyudmyla Symochko, Uzhhorod National University, Uzhhorod, Ukraine  
Lütfi Saltuk Demir, Faculty Of Medicine, Necmettin Erbakan University, Konya, Türkiye  
Mahirah Binti Kamaludin, University Malaysia Terengganu, Malaysia  
Maris Klavins, Environmental Science Department, University of Latvia, Latvia  
Marsela Alikaj, Agricultural University of Tirana, Albania  
Massimo Zucchetti, Dipartimento Di Energetica, Torino Polytechnic University, Italy  
Mazin Nazar Fadhel Al-Sanjari, College of Environ. Science & Technology, Musul Un., Iraq  
Mehmet Emin Argun, Konya Technical University, Konya, Türkiye  
Mehmet Kılıç, Engineering Faculty, Süleyman Demirel University, Isparta  
Mirela Lika (Çekani), Faculty of Natural Sciences, University of Tirana, Tirana

**Proceeding Book of ISESER2023**

Mohamed Shahrir Mohamed Zahari, University Malaysia Terengganu, Malaysia  
Mohammad Shahriari, Chalmers University Of Thechnology, Sweden  
Mohammed Faraj Shather Al Marjani, College of Science, Mustansiriyah University. Iraq  
Mustafa Işık, Engineering Faculty, Aksaray University, Aksaray, Türkiye  
Mustafa Karatas, Engineering Faculty, Aksaray University, Aksaray, Türkiye  
Mustafa Sagdic, Yildiz Technical University, Istanbul, Türkiye  
Mustapha Hasnaoui, University of Sultan Moulay Slimane, Morocco  
Mustaq Abdulameer Alwan Almuslehi, Engineering Faculty, Diyala Univerity, Iraq  
N. Modirshahla, Islamic Azad University, Iran  
Nahida Hameed Hamza Alqaysi, Engineering Faculty, Diyala Univerity, Iraq  
Najma Memon, University of Sindh, Jamshoro, Pakistan  
Nicola Senesi, University of Bari, Bari, Italia  
Nilgün Balkaya, Engineering Faculty, İstanbul University, Istanbul, Türkiye  
Nilgün Yenil Harmançı, Manisa Celal Bayar University, Manisa, Türkiye  
Noor Zaitun Yahaya, University Malaysia Terengganu, Malaysia  
Nurten Deva, University of Mitrovica "Isa Boletini" (UMIB), Mitrovica, Kosovo  
Nurul Adyani Ghazali, University Malaysia Terengganu, Malaysia  
Petr Madera, Mendel University, Czech Republic  
Razifah Mohd Razali, University Malaysia Terengganu, Malaysia  
Rüdiger Anlauf, Applied Sciences, Osnabrueck University, Germany  
Saimir Kristo, University Barleti, Tirana, Albania  
Senar Aydın, Engineering Faculty, Necmettin Erbakan University, Konya, Türkiye  
Scott S. Knight, Usda-Ars National Sedimentation Laboratory, Oxford University, USA  
Shahabuddin Memon, Sindh University, National Centre of Excellence, Jamshoro, Pakistan  
Shpend Bengu, Department of Art Design, Albanian University, Tirana, Albania  
Somjai Karnchanawong, Faculty of Engineering, Chiang Mai University, Thailand  
Spase Shumka, Biotechnology & Food Faculty, Tirana Agriculture University, Albania  
Stamatis Zogaris, Institute of Marine Biology, Hcmr University, Greece  
Tahir Kemal Şahin, Faculty Of Medicine, Necmettin Erbakan University, Konya, Türkiye  
Tarit Roychowdhury, School Of Environmental Studies, Jadavpur University, India  
Tay Joo Hwa, Nanyang University of Technology, Singapore  
Umar Hamzah, Science and Technology Faculty, Malaysia National University, Malaysia  
Victor A. Dryban, National Academy of Sciences of Ukraine, Ukraine  
Yasemin Durduran, Faculty Of Medicine, Necmettin Erbakan University, Konya, Türkiye

**Advisory Committee**

Aelita MANI, "Luarasi" University, Albania  
Blerina Vrenozi, Natural Science Faculty, Tirana University, Albania  
Fatma Didem Tunçez, Economics and Administrative Sciences Faculty, KTO Karatay University, Konya, Türkiye  
Eralda NOÇKA (SHORE), Agricultural University of Tirana, Albania  
Hüseyin Deveci Vice Rector Konya Technical University, Konya, Türkiye  
Mirela Alushllari, Institute of Applied Nuclear Physics, University of Tirana, Tirana, Albania  
Mohamed Shahrir Mohamed Zahari, University Malaysia Terengganu, Malaysia  
Noor Zaitun Zakaria, University Malaysia Terengganu, Malaysia  
Noorlin Mohamed, University Malaysia Terengganu, Malaysia  
Nurul Adyani Ghazali, University Malaysia Terengganu, Malaysia  
Prithwiraj Jha, Raiganj Surendranath College, University of Gour Banga, India  
Razifah Mohd Razali, University Malaysia Terengganu, Malaysia  
Sevda Ocak, Engineering Faculty, Giresun University, Giresun, Türkiye  
Sezen Küçükçongar, Engineering and Natural Sciences Faculty, Konya Technical University, Konya, Türkiye  
Wan Nurdiyana Wan Mansur, University Malaysia Terengganu, Malaysia

**Proceeding Book of ISESER2023**

Zehra Gök, Vocational School, Selçuk University, Konya, Türkiye

**Symposium Coordinator**

Sukru Dursun, Engineering and Natural Sciences Faculty, Konya Technical University, Konya, Türkiye  
Noor Zaitun Yahaya, Faculty of Ocean Engineering Technology and Informatics, University Malaysia Terengganu, Malaysia  
Hüseyin Toros, Engineering Faculty, Istanbul Technical University, Istanbul, Türkiye  
Fatma Kunt, Engineering Faculty, Necmettin Erbakan University, Konya, Türkiye

**Organization Committee**

Çiğdem Çiftçi, Faculty of Engineering and Architecture, Necmettin Erbakan University, Konya, Türkiye  
Ertuğrul Esmeray, Karabük University, Engineering Faculty, Karabuk, Türkiye  
Flora Merko, Aleksander Moisiu Durres University, Albania  
Hysen Mankolli, Editor of IJEES, Health and Environment Association, Illinois, USA  
Laura Shumka, University Barleti, Tirana, Albania  
Lyudmyla Symochko, Uzhhorod National University, Uzhhorod, Ukraine  
Nurul Asyraf bt Razali, University Malaysia Terengganu, Malaysia  
Samsuri Abdullah, University Malaysia Terengganu, Malaysia  
Şerife Yurdagül Kumcu, Necmettin Erbakan University, Konya, Türkiye  
Zeynep Cansu Ayturan, Engineering and Natural Sciences Faculty, Konya Technical University, Konya, Türkiye  
Mehmet Yıldırım Gündüz, Engineering Faculty, Necmettin Erbakan University, Konya, Türkiye  
Busenur Köpüklü, Necmettin Erbakan University, Konya, Türkiye  
Emre Dalkılıç, Engineering and Natural Sciences Faculty, Konya Technical University, Konya, Türkiye  
Yasin Akın Ayturan, Engineering Faculty, KTO Karatay University, Konya, Türkiye

## **Opening Speech of the Mayor of Meram Municipality**

Welcome to the opening of the International Symposium for Environmental Science and Engineering Research 2023, which I believe will make significant contributions to the future of our environment and our world. To begin with, I would like to share with you, esteemed participants, the satisfaction I feel from holding such a valuable symposium regarding the environment, which is one of the most important problems in the world, in our Konya and Meram.

Dear Guests,

The world is becoming more uninhabitable with each passing day due to the mistakes made by human beings. Today, in our world, which is the common living space of all living things, human beings are supposed to maintain the balance of the earth, but unfortunately, they are positioned against nature with a lifestyle that is exactly the opposite. As we all know, natural resources such as clean air, clean water, fertile soil, and biodiversity is vital for building a sustainable future. However, today, the pressure on our environment is increasing, and our natural resources are rapidly depleting. Today we face climate change, sea acidification, forest fires, and other environmental threats. We need fair sharing and scientific wisdom to overcome these problems and re-establish a sustainable world. That's why the International Symposium for Environmental Science and Engineering Research provides a platform to find and share these solutions. This symposium provides an opportunity for scientists, engineers, academics, and experts from around the world to come together. Here we will discuss the latest developments and innovations in the field of environmental science and engineering, share our experiences, and explore cooperation possibilities. The main aim of this symposium is to shape a sustainable future by bringing together science and engineering to protect and improve our environment. We believe in the power of scientific approaches to find solutions to today's problems, and we organize this symposium with this belief.

Dear Guests,

As Turkey, we attach great importance to every work done on climate change and zero waste. The Zero Waste Movement, which was launched five years ago under the leadership of the esteemed First Lady Emine Erdoğan, achieved great success in a short time and showed the whole world the importance of human individual efforts in environmental problems. The Zero Waste Movement, established under the leadership of First Lady Erdoğan as an indicator of our sincere approach to this issue as a country, turned into an environmental movement with the support of 105 countries at the 77th General Assembly of the United Nations. Zero Waste Day, declared at the United Nations General Assembly, was celebrated for the first time on March 30. We, as the Republic of Turkey, our government, and local administrators, are taking sincere steps towards a more livable environment, and we will continue to do so. We believe that more equitable sharing is needed for a more livable environment. While we say, "World population is increasing; resources are not enough for humanity", we cannot throw away one-third of the food produced. We cannot talk about fair sharing when the number of children dying of hunger is the same as the number of children dying of obesity. Our world, which has hosted humanity for centuries, is waiting to be saved from humanity again today. The world will be saved by people who are concerned about this issue and can work individually and collectively on it. The world will be saved by people who think about a more equitable distribution and strive for it with science and common sense. Then our tomorrow will be more livable than our present.

Dear participants,

During the symposium, we will have the opportunity to learn about the latest developments in the field of environmental science and engineering, share our experiences, and establish new collaborations. This event is an expression of our commitment to leaving a cleaner, greener, and more sustainable world for future generations.



Ultimately, successfully completing this symposium will help us gain a better understanding of and more effective solutions to environmental problems around the world. Together, we can fulfill our responsibility to protect our environment and leave a livable world for future generations.

As I conclude my words, I would like to thank all the institutions and organizations that contributed to the realization of the symposium, and I hope that you, the valuable participants who gathered to save the world, will have an enjoyable and productive symposium period.

**The Mayor of Meram Municipality**  
Mustafa KAVUŞ

---

**CONTENTS**

O 1. ANKARA CITY MAMAK DISTRICT CENTRE SOLID WASTE POTENTIAL .....	1
O 2. FOREST FIRES AND ITS EFFECT ON AIR POLLUTION IN SUMMER .....	10
O 3. EVALUATION OF SPATIAL SUSTAINABILITY ON THE IMPORTANCE OF WALKABILITY IN CHOOSING THE LOCATION OF HOTELS IN THE CITY OF KONYA .	19
O 4. OBSTACLES TO AQUATIC ECOLOGY AND WATER CORRIDORS AS PART OF CLIMATE-ADAPTIVE SOLUTION TO A COMPLEX PROBLEM .....	20
O 5. THE SPATIOTEMPORAL IMPLICATIONS OF URBANIZATION FOR URBAN HEAT ISLANDS (UHI) IN TIRANA UNDER THREATENING EXTREME SUMMER TEMPERATURES .....	21
O 6. GEOLOGY AND HYDROCHEMICAL CHARACTERISTICS OF THE AKHÜYÜK SPRING (EREĞLİ-KONYA) AND ITS HOT MINERAL WATERS .....	22
O 7. THE EVALUATION OF THE SNOW CLIMATE INDICATOR IN SOME AREAS OF ILLINOIS, USA.....	23
O 8. THE EVALUATION OF RECREATIONAL AREAS IN TERMS OF ECOLOGICAL- CULTURAL TOURISM .....	27
O 9. AQUASCAPING AND WATERSCAPES AS AN UNDERWATER LANDSCAPE ART.....	37
O 10. ESKAPE PATHOGENS IN ECOSYSTEMS: QUANTITATIVE MICROBIAL RISK ASSESSMENT .....	46
O 11. GEOSMIN AND 2-METHYLISOBORNEOL REMOVAL FROM AKSARAY’S TAP WATER BY POWDERED ACTIVATED CARBON .....	47
O 12. OVERVIEW OF THE NEGATIVE EFFECTS OF CLIMATE CHANGE.....	48
O 13. CONSTRUCTION WASTE MANAGEMENT: KEY STUDY OF SKOPJE.....	55
O 14. INVESTIGATION OF THE CHANGE IN THE USE RATES OF NON-RENEWABLE ENERGY RESOURCES, WHICH HAVE A MAJOR ROLE IN AIR POLLUTION IN KONYA PROVINCE, BY YEAR .....	61
O 15. IMPORTANCE OF TRICLOSAN FOR ENVIRONMENT AND HUMAN HEALTH.....	69
O 16. MICROBIAL CENOSIS DEVELOPMENT IN THE SOIL OF CULTIVATED CROPS.....	77
O 17. DICHOTOMY ISSUES IN ENVIRONMENTAL ETHICS – A CRITICAL ANALYSIS OF ECO-ANTHROPOHOLISM .....	78
O 18. CURRENT KNOWLEDGE ON ANTIOXIDANT ACTIVITY AND INHIBITORY PARTICULARITIES OF CISTUS INCANUS (L.) COLLECTED IN CENTRAL ALBANIA .....	79
O 19. CURRENT KNOWLEDGE OF CONSERVATION STATUS OF FISHES OF VJOSA RIVER (ALBANIA).....	80
O 20. EVALUATION OF THE PHYTOCOENOSES CONDITION OF AGROLANDSCAPES OF THE RIGHT-BANK FOREST-STEPPE OF UKRAINE BY ANTHROPOGENIC FACTORS....	81
O 21. SOLAR POWER ELECTRICITY IN PUBLIC BUILDINGS ECO-FRIENDLY ENERGY SOLUTION– CASE STUDY THE ALBANIAN FOOTBALL ASSOCIATION BUILDING .....	82
O 22. IMPACT OF SOLID WASTE MANAGEMENT SYSTEM DURING THE COVID-19 PANDEMIC PERIOD .....	90
O 23. A NEW PARADIGM FOR AREA-BASED CONSERVATION; OTHER EFFECTIVE AREA- BASED CONSERVATION MEASURE; CASE OF KARACADAG .....	95
O 24. ARMED CONFLICT AND ITS IMPACT ON THE ENVIRONMENT: PRINCIPLES OF JUS AD BELLUM AND JUS IN BELLO .....	96

**Proceeding Book of ISESER2023**

O 25. AN ECOCRITICAL EXAMINATION OF ENVIRONMENTAL ETHICS AND CONSERVATION IN THE WORKS OF JOHN STEINBECK.....	97
O 26. AIR POLLUTION AND PUBLIC HEALTH IMPACTS DURING THE COVID-19 PANDEMIC.....	98
O 27. ESTIMATING OF EMISSIONS FROM CARGO AIRPLANES: A COMPARATIVE ANALYSIS AT TURKISH AIRPORTS.....	105
O 28. GRAPHICAL USER INTERFACE DESIGN FOR REMOVAL OF OUTLIERS DATA: YESILIRMAK RIVER EXAMPLE.....	106
O 29. ACRYLAMIDE/SODIUM ACRYLATE/POLYETHYLENE GLYCOL/KAOLIN COMPOSITE HYDROGELS FOR REMOVAL OF METHYLENE BLUE: DYE ADSORPTION ISOTHERMS AND KINETICS .....	107
O 30. COMPARISON OF METHODOLOGIES TO CALCULATION CARBON FOOTPRINT IN LIVESTOCK FARMS.....	108
O 31. INVESTIGATION OF MECHANIZATION LEVELS AND ENERGY EFFICIENCY OF DAIRY CATTLE FARMS IN EREĞLI DISTRICT OF KONYA PROVINCE.....	118
O 32. SUBSIDIZING AGRICULTURAL PRODUCTS TO PREVENT THEIR REPLACEMENT IN THE CASE OF CANNABIS LEGALIZATION – THE CASE OF ALBANIA.....	119
O 33. STRUCTURAL ANALYSE of GREENHOUSE SHEEP BARN for SHEEP BREEDING in KONYA#.....	126
O 34. URBAN WASTEWATER TREATMENT PLANT EFFICIENCY MODELING WITH ARTIFICIAL NEURAL NETWORK: KONYA EXAMPLE.....	136
O 35. INVESTIGATION OF PARAMETERS AFFECTING THE ADSORPTION PROPERTY OF PHOTOCATALYST IN THE REMOVAL OF ENDOSULFAN USING PHOTOCATALYSIS PROCESS .....	143
O 36. THE IMPORTANCE OF CONSERVATION AND THE RESTORATION OF HISTORICAL GARDENS AS SUSTAINABLE CULTURAL HERITAGE.....	152
O 37. PLANT SELECTIONS FOR EDIBLE GARDENS AND URBAN AGRICULTURE IN XERISCAPE LANDSCAPING.....	162
O 38. INVASIVE PLANT SPECIES IN THE URBAN ECOSYSTEM: BOSTANLI STREAM EXAMPLE; KARSIYAKA, IZMIR.....	171
O 39. EFFECT OF SALINE SOILS AND WATER QUALITY ON SOME COTTON TRAITS UNDER DIFFERENT LOCATIONS.....	179
O 40. EFFECT OF FERTILIZER LEVELS AND SOWING METHODS ON EARLINESS AND GRAIN YIELD OF SOME BREAD WHEAT.....	187
O 41. SOWING METHODS INFLUENCE ON GRAIN YIELD AND ITS COMPONENTS OF SOME WHEAT CULTIVARS UNDER DIFFERENT FERTILIZER LEVES.....	188
O 42. THE ROLE OF SOME ANTIOXIDANTS FOLIAR APPLICATION ON BIO-CHEMICAL AND YIELD OF TWO WHEAT CULTIVARS GROWN UNDER SALINITY STRESS .....	196
O 43. PROTECTIVE EFFICACY OF AN INACTIVATED VACCINE AGAINST RABBIT HEMORRHAGIC DISEASE VIRUS 2 PREPARED FROM A LOCAL ISOLATE IN EGYPT.....	214
O 44. APPLICATION OF MULTI-CRITERIA DECISION-MAKING METHODS IN SUSTAINABLE WATER RESOURCES MANAGEMENT: KONYA CASE .....	215
O 45. LEACHATE BASED GLUE SYNTHESIS APPROACH.....	220
O 46. PERSONNEL TRAINING IN IMPROVING THE PIPE PRODUCTION PROCESS .....	221
O 47. MICROGREEN FOOD CHOICE IN SUSTAINABILITY .....	222

**Proceeding Book of ISESER2023**

O 48. INTER-RELIGIOUS ADVOCACY IN THE PROMOTION OF ENVIRONMENTAL SCIENCE.....	225
O 49. MODERN URBAN DEVELOPMENT IN CALABAR: REDUCING HOUSING DEVELOPMENT'S ECOLOGICAL FOOTPRINT.....	226
O 50. IMPACT OF OUTSIDE FARES CUISINE ON TOURISM GROWTH IN CALABAR, NIGERIA .....	227
O 51. AGRICULTURAL FUNCTIONS FOR THE REQUIREMENTS FOR THE DEVELOPMENT OF AGRICULTURAL COOPERATIVES IN THE AL GHARBIA GOVERNORATE.....	228
O 52. THE CULTURAL, MORAL, AND RELIGIOUS DIMENSIONS OF ENVIRONMENTAL PROTECTION.....	229
O 53. BEHAVIOR OF SILLE STONE AGAINST ACID RAIN.....	230
O 54. THE EFFECT OF LAYOUT OF ENERGY DISSIPATORS ON ENERGY DISSIPATE.....	234
O 55. EFFECTS ON EARLY DEVELOPMENT OF HEAT STRESS IN WHEAT (TRITICUM DURUM) .....	242
O 56. MORPHOLOGICAL DIVERSITY OF SALICORNIA EUROPEAE POPULATIONS .....	243
O 57. MICROBIC QUALITY (CF/SF) AND SOME PHYSICO-CHEMICAL PARAMETERS IN SURFACE WATERS IN THE REGION OF SHKODRA, ALBANIA.....	244
P 1. A STUDY OF DIATOM DISTRIBUTION AND BIODEIVERSITY IN FRESH WATER OF VJOSA RIVER .....	248
P 2. ASSESSMENT OF ECOLOGICAL STATUS OF VJOSA RIVER IN ALBANIAN, BASED ON CHEMICAL INDICATORS AND BIOMONITORING .....	254
P 3. DETERMINATION OF PHYTOCHEMICAL COMPONENTS OF ACHILLEA MILLEFOLIUM IN DIFFERENT AREAS OF ALBANIA .....	259
P 4. BTEX MEASUREMENT RESULTS OF KONYA.....	266
P 5. CORN PRODUCTION AND EXPORT OPPORTUNITIES IN UKRAINE DURING TIMES OF WAR .....	267
P 6. REMOVAL OF As(V) FROM WATER BY USING PRE-COATED RED MUD MEMBRANES .....	268
P 7. ZERO WASTE INFORMATION SYSTEM (KOSABS).....	269

**O 1. ANKARA CITY MAMAK DISTRICT CENTRE SOLID WASTE POTENTIAL**

Esra GÜMÜŞ<sup>1\*</sup>, Şükrü DURSUN<sup>2</sup>

<sup>1</sup>*Konya Technical University, Institute of Graduate Studies Department of Environmental Engineering, Konya Türkiye*

<sup>2</sup>*Konya Technical University, Environmental Engineering Department, Konya, Türkiye*

E-mail: *esratorun185@gmail.com, sdursun@ktun.edu.tr*

**ABSTRACT:** Ankara Province is the capital city of Turkey and the second largest city in the country. While all the solid wastes of the city center were transported to the irregular landfill in the district of Mamak, a new sanitary landfill area was formed, and the rehabilitation of the Mamak landfill was started for the negative effects that occurred because the area reached a very large area and remained close to the settlements. Both the realization of rehabilitation works, and the solid waste management of this landfill are important. In this study, research on the determination and management of solid waste characteristics were carried out in Mamak district center of Ankara province. The activities of the Mamak Municipality, which operates in the field of waste management, for reducing the amount of waste, providing waste recovery and integrated management of the ITC-Mamak facility are examined. In the light of this information, the problems encountered in solid waste management were investigated and suggestions were presented. As a result, within the framework of the information obtained, it is important for the management to collect the solid wastes generated in the houses separately, to increase the amount of recycling and to reduce the amount of solid waste that will go to the landfill.

*Keywords: Integrated Solid Waste Management, Solid Waste Disposal, Mamak, Zero Waste*

**1. INTRODUCTION**

Changes in human behaviour and the expectation of a comfortable life have transformed humanity into a society that consumes more than before. As waste generation increases as a result of production and consumption activities of people, environmental impacts such as climate change and depletion of natural resources emerge. For a proper waste management, the use of natural resources should be reduced, waste should be rendered harmless and economic value should be created (Ulaşlı, 2018). Factors such as industrialisation, economic conditions, increase in population, urbanisation and welfare level in our country in recent years and today have caused waste problems. In this regard, "sustainable waste management approach" aiming to create zero or minimum waste has become a necessity (Ulaşlı, 2018).

In order to minimise the damages caused by solid wastes to individual health and the environment, appropriate and controlled methods should be used. These methods consist of collection, reuse, recycling, recycling, recovery and finally storage of solid wastes, and the zero waste approach is an understanding that has emerged in this context. Its main purpose is to prevent waste, to use resources more efficiently, to prevent or minimise waste generation by re-evaluating the causes of waste generation, and to ensure the recovery of waste by collecting it separately at its source. Solid waste management is the responsibility of waste generators and municipalities. For an efficient solid waste management, it is important to encourage individuals to recognise the waste produced, to raise awareness for the protection of nature and to encourage environmental cleanliness.

In this study, quantities and characterisation of solid wastes generated in Ankara-Mamak district centre, collection, accumulation and transport of solid wastes, locations of landfills, recovery of solid wastes, Mamak Municipality solid waste management services and zero waste practices, problems encountered in solid waste management were investigated. In the light of this information, the aim of the study is to prevent and reduce solid waste generation in Mamak district centre and to evaluate the work that can be done for a conscious waste management with an integrated approach. In addition, determining the problems encountered in solid waste management and presenting solution suggestions will also make an important contribution.

**Proceeding Book of ISESER 2023**

**2. MATERIAL AND METHOD**

In the first stage of the research, information was obtained from Mamak Municipality Directorate of Cleaning Affairs by face-to-face interview technique about the amount and characterisation of solid wastes generated in Mamak district centre, waste management, collection and transportation of solid wastes, Mamak Municipality solid waste management services and zero waste practices, problems encountered in solid waste management services. In the second stage, face-to-face interview technique was applied with the responsible personnel of ITC Integrated Solid Waste Management Systems Facility and detailed information was obtained about the location of landfill areas and recycling of solid wastes.

**2.1. Characteristics of the Study Area**

This study was conducted in the centre of Mamak district of Ankara province located in the Central Anatolia Region of the Republic of Turkey. Mamak district consists of 65 neighbourhoods. The district is neighbored by Altındağ in the north, Elmadağ in the east, Çankaya and Elmadağ in the south, Çankaya and Altındağ in the west. The district has a typical continental climate. The winter season is rainy and cold, and the summer season is hot and dry. The annual rainfall in the region is approximately 360-420 kg/m<sup>2</sup>. The distance to Ankara city centre is 3.5 km. Its height from the sea is 899 m and its surface area is 308 km<sup>2</sup>. Mamak district has a hilly geography (Mamak Municipality Promotional Booklet, 2021). Service Sector, Mining Sector, Agriculture Sector, Industry and Trade Sector are important on the district economy respectively. The main economic activities in the district are civil servant, tradesman, private sector and construction labour. In addition, Slums and Infrastructure, Unemployment, Lack of Education, Security and Transport are seen as the main problems of the district (Mamak Municipality, 2022).

According to 31 December 2022 Address Based Population Registration System results, Mamak district has a population of 687,535 people (TUIK, 2022). It is the 4th largest district of Ankara according to population density. The total female population of Mamak district is 346,420 and the total male population is 340,915. As a percentage, 50.38% of the total population is female and 49.62% is male. It is seen that the population of Mamak has been increasing from past years to the present. Mamak population statistics between 2007-2022 are shown in the table.

**2.2. Mamak landfill**

Since the 1950s, Mamak has been one of the most important symbols of squatting, unplanned urbanisation and environmental destruction. The most important cause of environmental destruction is the Mamak landfill (Özaslan, 2014). Mamak landfill is a large solid waste landfill with an area of 26.6 hectares (Güngör and Torunoğlu, 2022). Since it is thought that the Mamak landfill may cause negative effects such as epidemic disease, pollution of natural resources, visual pollution, bad odours, the release of gases causing the greenhouse effect into the atmosphere and the danger of explosion, urgent improvement research has been started. Mamak landfill has been transformed into a recyclable solid waste reclamation centre by Ankara Metropolitan Municipality through a project with ITC, which started its operations in 2002.

The first scientific study on the municipal solid waste problem in Ankara started with a report prepared by TUBITAK in 1983. In this study, the wastes produced in Ankara are acidic (4.5<PH<5.8), have low (12-17) carbon/nitrogen ratio and low (250-360 kcal/kg) calorific value. Therefore, it was determined that landfilling is the most appropriate solution (Arıkan et al, 2004).

**Table 1.** Mamak District Population between 2007-2022 (TUIK, 2022)

<b>Year</b>	<b>Mamak Population</b>	<b>Male Population</b>	<b>Female Population</b>
2022	<b>687.535</b>	340.915	346.620
2021	<b>682.420</b>	340.018	342.402
2020	<b>669.465</b>	333.567	335.898
2019	<b>665.978</b>	332.512	333.466
2018	<b>647.252</b>	323.710	323.542
2017	<b>637.935</b>	318.309	319.626
2016	<b>625.083</b>	313.174	311.909

2015	<b>607.878</b>	304.502	303.376
2014	<b>587.565</b>	394.672	292.893
2013	<b>568.396</b>	284.830	283.566
2012	<b>559.597</b>	282.464	277.133
2011	<b>558.223</b>	284.649	273.574
2010	<b>549.585</b>	281.036	268.549
2009	<b>532.873</b>	271.531	261.342
2008	<b>520.446</b>	263.156	257.290
2007	<b>503.663</b>	254.647	249.016

### 2.3. Zero Waste Target

In Turkey, waste disposal and urban cleaning services were implemented by municipalities to protect environmental health from 1930 to 2017. Since 2017, the "Zero Waste Project" has been launched by the Ministry of Environment, Urbanisation and Climate Change and implemented in all public institutions. If the zero-waste target is introduced as a culture in all living spaces and made compulsory with legal support, the rate of achieving this goal is very high (Erdur, 2019).

In order to ensure the effectiveness of the Zero Waste Project, plastic bags have been charged since 2019. It was observed that the amount of plastic shopping bags used in 2019, 2020 and 2021 decreased by approximately 65%. With this reduction, 550,000 tonnes of plastic waste and 22,746 tonnes of greenhouse gas emissions were prevented (Anonymous, 2019).

With the Zero Waste Project launched in 2017, the recovery rate was 13% and reached 27.2% as of June 2022. These rates are important in terms of reducing the negative effects of climate change, protecting raw material resources and using them efficiently. Total economic gain reached 62.2 billion TL. In addition, 3.9 million tonnes of greenhouse gases were prevented (Table 2) (Anonymous, 2019).

**Table 2.** Zero Waste Project in Figures (2017-2022) (Ministry of Environment, Urbanisation and Climate Change General Directorate of Environmental Management)

Recovery Rate	27,2 %
Economic Gain	62,2 billion TL
Energy Saving	530 million kwh
Water Saving	572 million m <sup>3</sup>
Storage Space Saving	69 million m <sup>3</sup>
Greenhouse Gas Emissions Prevented	3,9 million tonnes
trees saved	347 million
Barrel of Oil Saving	87 million units
Raw Material Savings	650 milyon tonnes
<b>Recovery Amount/Ratio</b>	
Plastic Bags	550.000 tonnes
Paper/Cardboard	20,4 million tonnes
Plastic	5.4 million tonnes
Glass	2.3 million tonnes
Metal	0.5 million tonnes
Organic et al.	5.2 million tonnes
Wastewater treatment rate	4.2 %

## 3. FINDINGS

### 3.1. Mamak Municipality Solid Waste Management Works

In the Republic of Turkey, metropolitan municipalities and other municipalities are assigned for solid waste management activities, establishment, construction, operation or commissioning of solid waste disposal facilities. Mamak district solid waste management activities are carried out by Mamak Municipality Directorate of Cleaning Affairs. Solid domestic wastes generated in the settlements within

## **Proceeding Book of ISESER 2023**

the municipality boundaries are collected on a daily basis and these wastes are transported to solid waste landfills within the framework of a waste management plan. Garbage containers have been placed in places deemed necessary so as not to spoil the appearance of the district. The streets and avenues of Mamak district are cleaned within a plan and co-operation is made with Ankara Metropolitan Municipality on environmental cleaning. Work is being carried out within the scope of the zero waste project. In this context, Mamak Municipality 1st Class Waste Collection Centre was put into service. Inspections are carried out in the enterprises within the borders of Mamak, and it is ensured that these enterprises make contracts with collectors who have storage permits or licensed recycling facilities. In Mamak district, necessary warnings are given to individuals who harm the environment, and those who do not comply with the rules are treated within the legal framework. Cleaning of 23 market places established within the borders of Mamak district is carried out in a regular plan and programme. The public is informed about used batteries and accumulators, and waste batteries and accumulators are collected separately from other solid wastes and delivered to transport companies. Training and awareness-raising activities on environment and cleanliness are carried out for both citizens and municipal employees (Mamak Municipality Directorate of Cleaning Affairs Regulation on Establishment, Duties, Authorities, Responsibilities and Working Principles, 2021).

According to the Municipal Law No. 5393 and Metropolitan Municipality Law No. 5216, the responsibility of collecting and transporting solid wastes to transfer stations belongs to district municipalities. With the "Smart Waste Collection System" developed by Mamak Municipality, the fullness, cleanliness and collection systems of garbage containers can be monitored online on maps. This system records online how long it takes for the collection vehicles to reach which neighbourhood and whether the garbage in the containers has been collected or not. Thanks to the system, the complaints of the residents of the district can be intervened immediately, and it will be possible to monitor whether the garbage removal hours are observed or not. In the system, empty containers from which waste has been collected will be indicated with a green light and full containers from which waste has not been collected will be indicated with a red light. Container occupancy will be monitored and municipalities will be able to save fuel and time. A specially developed navigation panel will be used to determine the best route to the waste container with a dynamic routing programme. Since municipalities allocate a large part of their budgets to collection and transport, this system is an important application in waste management to increase recycling rates and reduce costs arising from solid waste (Mamak Municipality, 2020).

Mamak 1st Class Waste Collection Centre serves on Mamak Samsun road on an area of 1562 m<sup>2</sup> within the scope of Zero Waste project. With the support and contributions of the Ministry of Environment, Urbanisation and Climate Change, 14 categories of waste are accepted to this facility, which was opened with the aim of recycling recyclable wastes to the economy, ensuring their disposal and preventing pollution caused by wastes. These waste types are paper, glass, plastic, wood, cardboard, metal, electronic materials, leaded batteries, textiles, fluorescent and mercury-containing wastes, accumulators, waste medicines, vegetable waste oils, household hazardous wastes (such as solvents, paints, sprays), end-of-life tyres. The resident population can bring their wastes themselves or call the Mamak ALO ATIK line to express their requests and complaints and have their wastes collected from their addresses (Mamak Municipality, 2021).

### **3.2. Mamak Municipality Education and Awareness Raising Activities**

Mobile Recycling Information and Awareness Bus (ATİKO) was designed for children by Mamak Municipality Cleaning Affairs Directorate for zero waste awareness raising activities. It was delivered to the Directorate of Culture and Social Affairs ready for educational activities. ATİKO continues its education and awareness-raising activities with the understanding of My Future is in My Hands - We are reshaping the world of the future with the recycling and waste project (2022-2023).

In 2022, various environmentalist projects were put into operation in cooperation with the textile company and Mamak Municipality in order to raise awareness of citizens on waste management. Within the scope of the smiling recycling of textile project, the protocol signed for the collection of textile/clothing wastes (article 4.2.16), since reuse cannot be made in order not to cause the spread of the risk of disease transmission due to COVID-19, 1000 gift clothes vouchers were given to 1000 children in need instead of reuse. (500 presentations were made at this festival.) All expenses were covered by the textile recycling company.



## **Proceeding Book of ISESER 2023**

In May 2022, education and awareness-raising activities were carried out with university students (Gazi-Odtü- Hacettepe- environmental communities) by distributing brochures and packaging waste collection bags on recycling waste door-to-door.

### **3.3. ITC Integrated Solid Waste Management Systems**

ITC Integrated Solid Waste Management Systems started its operations in 2002. As the first target of the system, the rehabilitation of wild landfills such as the Mamak landfill is carried out and the effects on human and environmental health are minimised. Problems such as bad odour, slipping and explosion risk are eliminated thanks to works such as collecting leachate and landfill gas. ITC Integrated Solid Waste Management Systems The units in the Mamak facility include pre-separation, biomethanisation, composting, energy production, waste derived fuel (WDF) production and 2nd class landfill operations. Daily 1,500 tonnes/day of municipal solid waste reaches the Mamak facility.

Mixed household wastes are divided into 3 groups as organic, recyclable and residual waste in a pre-sorting system. Recyclable wastes such as glass, plastic, aluminium and metal are sent to licensed recycling facilities for recycling. Biodegradable wastes such as vegetables, fruits, park/garden wastes, which constitute more than 50% of household wastes, are also sent to biomethanisation facilities. The remaining wastes are processed according to their calorific value and used as waste derived fuel (WDF). At the end of all these processes, the remaining pulp and a certain amount of biodegradable waste are disposed of in the 2nd class landfill site. Biogas from the biomethanisation system and landfill gas collected from landfills are used to generate electricity in power generation plants. The heat generated during biogas production is utilised in greenhouses. In these greenhouses, tomatoes, strawberries, orchids and cucumbers are grown without using fossil fuels. In ITC facilities, the waste heat generated during energy production is also used to heat greenhouses, biomethanisation tanks, administrative and social buildings in some facilities, and residential and shopping centres near some facilities (Cem, 2020).

### **3.4. Solid Waste Potential of Mamak District**

The amount and composition of municipal solid wastes may vary depending on population density, geographical characteristics, climate, socio-economic status, seasonal changes, per capita income level. For 2021, the average amount of solid waste collected daily in Ankara is 5,000 tonnes and the average amount of waste generated per person is 1.03 kg/day. There are 13 privately operated transfer stations in the province. There are 2 landfills operating in Mamak and Sincan districts of Ankara. As of 2021, waste characterisation for Ankara is shown in the figure (Ankara Directorate of Environment, Urbanisation and Climate Change, 2021).

The solid waste potential generated in Mamak district between 2013-2022 is expressed numerically in the table. Monthly change of 2022 waste tonnages of Mamak district is shown in Table 4.

Mamak district solid waste characterisation studies were carried out on 01.10.2021 and 04.10.2021 at Mamak Solid Waste Area. The studies were carried out on municipal wastes transported by 4 vehicles bringing waste from 3 regions of the district with low, middle and high income levels and the bazaar area, and the results obtained are given below.

According to the information obtained as a result of one-to-one interviews with the responsible personnel of Mamak Municipality Directorate of Cleaning Affairs, 'Street Collectors' pose a problem in solid waste management. Street collectors cause problems such as collecting the wastes on the spot without complying with hygiene rules, in unhealthy conditions, using unsuitable hand and storage tools, and causing environmental and visual pollution by spreading the garbage around. Failure to ensure occupational health and safety, unregistered economic value obtained from waste, and precarious work also come to the fore (Ekşi, 2017).

**Proceeding Book of ISESER 2023**

**Table 3.** Mamak district solid waste amounts collected between 2013-2022 (Mamak Municipality Directorate of Cleaning Affairs, 2022)

<b>Amount of Waste Collected between 2013-2022 (Mamak Municipality Directorate of Cleaning Affairs, 2022)</b>									
<b>Year</b>	<b>Domestic waste kg</b>	<b>Packaging waste kg</b>	<b>Textile waste kg</b>	<b>Vegetable oil waste kg</b>	<b>Pharmaceutical waste kg</b>	<b>Battery kg</b>	<b>Electronic waste kg</b>	<b>Hazardous waste fluorescents kg</b>	<b>Hazardous waste cartridges kg</b>
<b>2013</b>	Archive record could not found.	2.795.017		8.770					
<b>2014</b>	Archive record could not found.	4.075.430		17.480					
<b>2015</b>	160.220.480	4.120.660		3.100		2.730			
<b>2016</b>	160.480.830	5.631.480				1.759			
<b>2017</b>	162.980.010	6.903.120				469,50			
<b>2018</b>	179.601.600	12.620.680				5.057,90			
<b>2019</b>	175.378.585	7.102.020				560,19			
<b>2020</b>	191.306.170	1.225.320				1.338,20			
<b>2021</b>	184.018.310	2.505.740	17.172	1.947	239	253	77	550	50
<b>2022</b>	172.796.800	818.710	363.400	3.372	6	20	15	-	350
<b>TOTAL</b>	1.386.782.780	47.971.377	380.572	34.669	245	12.187,79	92		400

**Table 4.** Mamak district solid waste amounts collected between 2013-2022 (Mamak Municipality Directorate of Cleaning Affairs, 2022)

<b>2022 WASTE TONNAGES</b>									
<b>Month</b>	<b>Domestic waste kg</b>	<b>Packaging waste kg</b>	<b>Textile waste kg</b>	<b>Vegetable oil waste kg</b>	<b>Pharmaceutical waste kg</b>	<b>Battery kg</b>	<b>Electronic waste kg</b>	<b>Hazardous waste fluorescents kg</b>	<b>Hazardous waste cartridges kg</b>
<b>January</b>	14.134.000	7.940	50	260					50
<b>February</b>	13.110.000	30.920	19.890	170					50
<b>March</b>	13.790.000	62.660	33.980	135					

**Proceeding Book of ISESER 2023**

<b>April</b>	13.756.000	71.200	48.760	0					
<b>May</b>	14.081.680	120.070	45.780	0	6		15		50
<b>June</b>	14.793.900	68.080	33.210	400					
<b>July</b>	15.662.620	55.490	30.770	265					
<b>August</b>	16.339.000	80.240	29.500	300					100
<b>September</b>	14.874.600	86.360	35.710	250					
<b>October</b>	14.866.800	99.700	40.140	556					
<b>November</b>	14.146.450	60.730	25.610	386					
<b>December</b>	13.241.750	75.320	20.000	650		20			100
<b>TOTAL</b>	172.796.800	818.710	363.400	3.372	6	20	15		350

**Table 5.** 2021 Mamak district solid waste characterisation study results (Ankara Metropolitan Municipality, 2021)

Solid waste component	Income levels				Average net quantity	Average
	low	middle	high	bazaar		
<b>Biodegradable waste</b>	190,50 kg	254 kg	200,50 kg	118,50 kg	190,88 kg	47,66%
<b>Paper</b>	18,50 kg	2,50 kg	7 kg	17 kg	11,25 kg	2,81%
<b>Cardboard</b>	6,50 kg	3 kg	15 kg	55 kg	19,88 kg	4,96%
<b>Plastic(Recycable)</b>	7,50 kg	10 kg	8 kg	6,50 kg	8 kg	2%
<b>Plastic(non-recycable)</b>	44,50 kg	37 kg	46,50 kg	89 kg	54,25 kg	13,55%
<b>Glass</b>	12,50 kg	17 kg	20,50 kg	8 kg	14,50 kg	3,62%
<b>Iron metal</b>	0 kg	1 kg	0,50 kg	2 kg	0 kg	0%
<b>Non-ferrous metal</b>	0,50 kg	1,50 kg	1 kg	7 kg	2,50 kg	0,62%
<b>Waste Electrical and Electronic Equipment</b>	0,50 kg	0 kg	0 kg	0 kg	0,13 kg	0,03%
<b>Hazardous Waste</b>	0 kg	0 kg	0 kg	0 kg	0 kg	0%
<b>Park and Garden Waste</b>	10 kg	6,50 kg	0 kg	0 kg	4,13 kg	1,03%
<b>Other non-combustibles</b>	1 kg	0 kg	3 kg	0 kg	1 kg	0,25%
<b>Other combustibles</b>	120 kg	164 kg	76 kg	16 kg	94 kg	23,47%
<b>Others</b>	0 kg	0 kg	0 kg	0 kg	0 kg	0%
<b>TOTAL</b>	<b>412 kg</b>	<b>496,50 kg</b>	<b>378 kg</b>	<b>319 kg</b>	<b>400,50 kg</b>	<b>100%</b>

**4. CONCLUSION, DISCUSSION AND SUGGESTIONS**

Solid waste potential can vary greatly between countries and between urban and rural areas depending on geographical, climatic, socio-economic and seasonal factors. According to the results of the solid waste characterisation study of Mamak district, the highest amount of biodegradable waste is

**Proceeding Book of ISESER 2023**

47.66% in Mamak. Looking at the values in the table, the amount of recyclable waste is around 14.1%. It is estimated that street waste collectors have an effect on the rate of recyclable waste.

It is thought that the employment of street waste collectors as registered waste workers will be beneficial in terms of improving the waste management process. As a result, it is foreseen that the registration of street waste collectors in coordination with the municipality and private sector, making their work more systematised and improving their working conditions will reduce the problems in waste management. In addition, it is thought that the inclusion of street waste collectors in the system will ensure efficiency in the separate collection of waste.

It is thought that the Smart Waste Collection System will make a great contribution to the municipalities in terms of enabling individuals to use it actively in daily life and to monitor the wastes accumulated instantly on this system in an online manner, and it is considered that such projects will positively affect the activities carried out within the scope of combating waste.

By developing the Smart Collection System, it is thought that it will be beneficial in encouraging citizens to contribute to recycling by establishing a smart mobile application system that will provide information on how the waste should be separated, the location and distance of the containers where the separated wastes will be left, for those who cannot take their wastes to the waste centre, they can contact the waste teams through the application and get their waste picked up and earn money points in return.

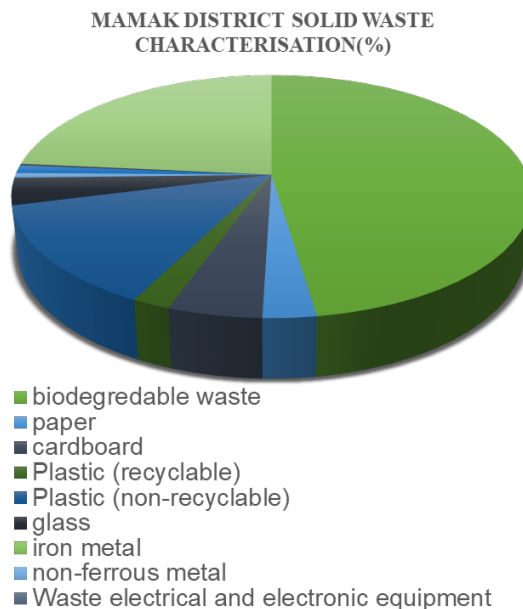

**Figure 2.** 2021 solid waste characterisation of Mamak district

When the training and awareness-raising activities of Mamak Municipality are examined, it is seen that important activities are carried out for a sustainable future and an environmentally friendly waste management. Increasing such activities and organisations, focusing on and supporting awareness raising activities by citizens will contribute to the formation of zero waste culture.

When the activities of ITC Integrated Mamak Facilities are analysed, it is seen that the management of wastes and the sustainability of the energy produced from waste are environmentally important. It is seen that the organic waste potential in Ankara is high and it is aimed to add value to the wastes by converting these wastes into energy. It is ensured that the energy need is met without harming the environment. It is important to support the use of renewable energy by developing innovative technologies through research and development activities.

Waste management continues to maintain its importance at global and national level. For sustainable and effective waste management and minimisation of waste, it is important that all interactions such as industry, legislators, science, private sector and waste generators meet on a common ground and work together. From an environmental, social and economic perspective, which are the three basic elements of sustainability, waste is a very important concept to manage in all three elements.

**Proceeding Book of ISESER 2023**

Considering waste as a secondary resource, creating new employment areas both in terms of economic and environmental benefits and sociological aspects, and the interaction of these three basic elements are considered to be a subject that should be examined in future studies.

**REFERENCES**

- Ankara Provincial Directorate of Environment, Urbanisation and Climate Change, 2021, Ankara Environmental Status Report, [https://webdosya.csb.gov.tr/db/ced/icerikler/ankara\\_cdr2021-20220902104900.pdf](https://webdosya.csb.gov.tr/db/ced/icerikler/ankara_cdr2021-20220902104900.pdf) [Date of Visit: 18.05.2022].
- Anonymous, 2019, Zero Waste, Ministry of Environment, Urbanisation and Climate Change <https://sifiratik.gov.tr/kutuphane/sifir-atik-kitabi#2816> [Date of Visit: 17.04.2023].
- Arikan, Y. Uzal, N. Oğuz, M. Demirel G. 2004. Characterisation of Mamak Urban Solid Waste Landfill Surface Leachate and its Effects on Imrahor Stream V. National Environmental Engineering Congress, TMMOB Chamber of Environmental Engineers, 2 (1), 112-116.
- Cem, E. 2020, Solid Waste Management and Model Proposal. Term Project, Ankara University, Ankara.
- Ekşi, A. 2017, Evaluation of the Problem of Street Waste Collectors with a Different Perspective, *Yüzüncü Yıl University Journal of Institute of Social Sciences*, Volume 1 Issue 4 Special Issue 1-13.
- Erdur, E. 2019, Zero Waste Project in Turkey and Implementation of the Project in Public Institutions; The Case of Süleymanpaşa Municipality. Master Thesis. Gazi University Institute of Science and Technology, Ankara, 1-81.
- Güngör, K. Torunoğlu E. 2008, *Turkey Engineering News*, Issue 409, 2000,5, Ankara.
- Mamak Municipality Introduction Booklet, 2020, T.C Mamak Municipality Publications ISBN: 9786058710436, Ankara.
- Mamak Municipality Cleaning Affairs Directorate Establishment, Duties, Authorities, Responsibilities and Working Principles Regulation, 2022, <https://wpimages.mamak.bel.tr/2022/09/yonetmeliktemizlikisleri.pdf> [Date of Visit: 04.05.2022].
- Mamak Municipality, 2021, Ankara's first 1st Class Waste Collection Centre was put into service, <https://www.mamak.bel.tr/haber/ankaranin-ilk-1-sinif-atik-getirme-merkezi-hizmete-acildi/>[Date of Visit: 16.01.2023].
- Mamak Municipality, 2020, <https://www.mamak.bel.tr/haber/konteynerden-al-haberi/> [Date of Visit: 31.05.2023]
- Mamak Municipality, 2022, Mamak Municipality Municipality 2022 Year Investment and Work Programme, <https://wpimages.mamak.bel.tr/2022/01/2022-YATiRiM-VE-CALiSMA-PROGRAMi.pdf> [Visit Date: 15.11. 2022]
- Özaslan, M. 2014, Ankara's Kahtane Kayaş and Mamak, *Journal of Ideal Urban Studies*, 5, 11, 288-299.
- TUIK, 2022, Favourite Reports, [https://www.tuik.gov.tr/indir/duyuru/favori\\_raporlar.xlsx](https://www.tuik.gov.tr/indir/duyuru/favori_raporlar.xlsx) [Visit Date: 11.03.2023].
- Ulaşlı, K., 2018. Management of Recoverable Wastes and Zero Waste Project Practices: Kadıköy Municipality, Master's Thesis, Hasan Kalyoncu University Institute of Science and Technology, Gaziantep, 1-3.

## **O 2. FOREST FIRES AND ITS EFFECT ON AIR POLLUTION IN SUMMER**

Büşra KIRBIYIK<sup>1\*</sup>, Şükrü DURSUN<sup>2</sup>

<sup>1</sup>*Konya Technical University, Institute of Graduate Studies Department of Environmental Engineering, Konya Türkiye*

<sup>2</sup>*Konya Technical University, Environmental Engineering Department, Konya, Türkiye*

E-mail: [busraarisoy@gmail.com](mailto:busraarisoy@gmail.com), [sdursun@ktun.edu.tr](mailto:sdursun@ktun.edu.tr)

**ABSTRACT:** Air pollution levels; It shows how much the interaction is between particles such as dust, smoke, odour, water vapor and gas, and chemicals that are in amounts that can harm living things and the environment. While determining the level of air pollution, it is essential to consider the structure of the region and meteorological conditions. It is known that the factors causing air pollution can have negative effects on living and environmental health and can create significant effects, and therefore air pollution is seen as an important problem. In order to reduce these effects, it is important to improve air quality as well as measuring pollutants and monitoring air quality; It is necessary to determine the source of the cause of pollution. Especially in hot and dry weather, forests with large combustible materials, which are at risk of fire, can therefore be damaged. The air temperature reaching high points, the relative humidity falling below 30%, and the drying winds that reduce the direction, intensity and humidity of the wind are the reasons for the emergence and spread of forest fires. Air pollution, the source of which is forest fire, especially due to the duration and severity of exposure to particulate matter; It can cause irritation in the respiratory tract, burning in the nose and eyes, decrease in air volume in the lungs, diseases such as asthma, bronchitis, heart failure, and even premature death. About 90% of the particulate matter emitted from the smoke caused by forest fires consists of PM and is of different sizes. The spread of forest fires, whether they are long or short; Short- and long-term weather changes such as atmospheric pressure, increase-decrease in temperature, wind direction and strength, decrease-increase in relative humidity and precipitation played a major role.

*Keywords: Air Pollution, Dust, Smoke, Forest Fire, Wind Direction*

### **1. INTRODUCTION**

Air pollution levels; It shows how much the interaction is between particles such as dust, smoke, odour, water vapor and gas, and chemicals that are in amounts that can harm living things and the environment (Qasim, 2019). While determining the level of air pollution, it is essential to consider the structure of the region and meteorological conditions (Kunt, 2018). It is known that the factors causing air pollution can have negative effects on living and environmental health and can create significant effects, and therefore air pollution is seen as an important problem. In order to reduce these effects, it is important to improve air quality as well as measuring pollutants and monitoring air quality; It is necessary to determine the source of the cause of pollution (Dursun, 2021).

Weather, it can be expressed as a mixture of gases containing nitrogen and oxygen, which are of vital importance for living things (Aydınlı, 2009). Stable to nitrogen, oxygen and inert gases among the gases that make up the atmosphere; water vapor, carbon dioxide, ozone, etc. gases are called volatile. Among the gases that are not constantly present are pollutants.

Air Pollution, according to WHO, pollution in the atmosphere; It is the situation of pollution of the outdoor and/or indoor air with any agent that degrades its natural structure and changes its properties. It is known that heating in winter, motor vehicles in traffic, industrial facilities where production takes place and forest fires that occur for certain reasons are the main sources of air pollution. Among the pollutants that pose a danger to public health; particulate matter (PM), carbon monoxide (CO), ozone (O<sub>3</sub>), nitrogen dioxide (NO<sub>2</sub>) and sulfur dioxide (SO<sub>2</sub>) (Gül İ., 2018).

Air Pollutant Sources, pollutant parameters in solid, liquid or gaseous state can be defined as substances that can harm people's health, life of living things and the environment, depending on the amount, density and duration in the air (Gül İ., 2018). It is possible to divide the sources causing air pollution into 2;

**Proceeding Book of ISESER 2023**

**1. Artificial sources;** Fuel used for heating, motor vehicles, and air pollutant sources that occur as a result of human activities such as industry.

**2. Natural resources;** Forest fires, volcano, etc. are sources emitted directly into the atmosphere.

**Forest Fires,** Especially in hot and dry weather, forests with large combustible materials, which are at risk of fire, can therefore be damaged. The air temperature reaching high points, the relative humidity falling below 30%, and the drying winds that reduce the direction, intensity and humidity of the wind are the reasons for the emergence and spread of forest fires (Küçük,2016).

Forest fire is the presence of 4 main substances (Kavzoğlu, 2021). These;

- Negligence and carelessness (47%)
- Intention (10%)
- Natural/lightning (11%)
- Products of unknown cause (32%)

Air pollution, the source of which is forest fire, especially due to the duration and severity of exposure to particulate matter; It can cause irritation in the respiratory tract, burning in the nose and eyes, decrease in air volume in the lungs, diseases such as asthma, bronchitis, heart failure, and even premature death.

About 90% of the particulate matter emitted from the smoke caused by forest fires consists of PM and is of different sizes. The spread of forest fires, whether they are long or short; Short- and long-term weather changes such as atmospheric pressure, increase-decrease in temperature, wind direction and strength, decrease-increase in relative humidity and precipitation played a major role (Chandler vd., 1991).

Climatic conditions in which fires occur, especially forest fires; It has been determined that the temperature is high, the bond moisture and the moisture content of the combustible material are low.

Air temperatures above seasonal normals are reported, especially in periods when the burning area is large and there is significant increase in growth numbers (Lagouvardos et al., 2019; Turco et al., 2019).

**Air Pollutant Parameters**

**Table 1.1** Source and effects of Air Pollutants (Mihelcic ve Zimmerman, 2010)

Polluting	Source	Effects
NO <sub>2</sub>	It is formed when nitrogen (N <sub>2</sub> ) in the air reacts with O <sub>2</sub> during fuel combustion. Combustion processes and motor vehicles and equipment.	Its inhalation may consist of small irritating particles, thus causing respiratory problems in sensitive individuals. It is the substance that causes ozone formation. Some NO <sub>2</sub> s react with water vapor to form nitric acid, forming acidic rain, snow or fog.
SO <sub>2</sub>	It is produced when sulfur-containing fuels are burned or metals are extracted from sulfur-containing ore. Sulfur oxidizes and SO <sub>2</sub> is formed. About two-thirds of emissions come from burning coal to generate electricity.Improper combustion and combustion of fossil fuels.	It dissolves easily in water vapor, becomes sulfuric acid, can form small sulfate particles that increase respiratory disease and mortality rates, especially in children and the elderly. In addition to the turbidity created by sulfate particles, SO <sub>2</sub> can also accelerate the deterioration of building materials, including historical sculptures and architecture. Lung failure, arteriosclerosis and respiratory diseases.
CO	It is produced by incomplete combustion of fuels. Expulsion into air without complete combustion. More than half of the emissions are from vehicles on the road.	It bleeds easily. At low levels, the most serious health threat from even a single exposure is for those with cardiovascular problems. While high levels in the ambient atmosphere are rare, they can often cause suffocation indoors with poorly

**Proceeding Book of ISESER 2023**

		functioning heating systems and poor ventilation.
O <sub>3</sub>	There is no direct source of ozone. It is formed by a series of chemical reactions caused by sunlight. Transportation, natural gas wells, landfills...	It is known to be a strong respiratory irritant. Especially people with weak respiratory system are at risk. This includes people with lung disease, children, the elderly. Respiratory diseases such as lung inflammation, breathing difficulties, aggravated asthma, pneumonia can cause (URL 1.1).
PM	Some particles are acid, organic chemical, metal or soil. Some particles are created through atmospheric reactions of gases such as sulfur dioxide or nitrogen dioxide. All particles with a diameter of 10µm and less are considered PM10, and all particles with a diameter of 2.5µm and smaller are considered PM2.5.	PM10 appears to cause problems for the respiratory system. It has effects such as irritation of the respiratory tract, cough, irregular heartbeat, asthma, premature death in people with heart or lung disease. Primary particles may be this size, but most are larger. Most secondary particles are 10 µm smaller (URL 1.2).

Air Quality; In particular, the air quality of a region changes depending on human factors, and it can spread according to meteorological events. The areas that adversely affect air quality from human factors are transportation, industry and warming in winter. For this reason, measuring the air quality of a region is of great importance in terms of determining the quality of life of the people living in that region and taking the necessary precautions.

Environmental Protection Agency; It is an index created based on the limit values specified in the current legislation. The air quality index created for particulate matter (PM10), carbon monoxide (CO), sulfur dioxide (SO<sub>2</sub>), nitrogen dioxide (NO<sub>2</sub>) and ozone (O<sub>3</sub>), which are known as the main pollutants, is an important criterion for evaluating air quality (Tel,2019). With the air quality index created according to the air quality standards applied in our country, the health effects on living things are determined by classifying according to the concentration of pollutants in the air.

## **2. MATERIAL AND METHOD**

### **2.1. Material**

#### **2.1.1. Working Area**

Antalya is located in the west of the Mediterranean Region of our country and its location lies between 29.005'-32.963' west-east longitude and 35.281'-38.082' south-north latitude. Burdur, Isparta provinces and the northern part of Antalya; Karaman, Mersin provinces and the east of Antalya; Mediterranean with the southern part of Antalya; Muğla province and the west of Antalya; Konya province is adjacent to the northeast of Antalya. With a surface area of approximately 20,177 square kilometers and a population of 2.619.832 in 2021, it ranked fifth in our country's rankings (URL-2.1).

In Antalya, there is a Cold Semi-Continental Climate type in the inner parts, and in general, a Mediterranean climate, which is a climate type with high temperatures and no precipitation in the summers, rainy winters and warm temperatures. It is known that the temperature at noon in summer can reach over 40°, while the average temperature is between 28-36°. The temperature in winter generally varies between 10-20°. The annual average relative humidity is around 64% (URL-2.1).

According to the pressure, relative humidity, temperature and precipitation data received from the General Directorate of Meteorology, if the average values of the fire period (28/07/2021-06/08/2021) in 2021 are considered and compared with other months; It is observed that the relative humidity has decreased by half and the temperature has increased by an average of 4-5 °C.

Forest Structure; 1,146,062 hectares of forestland constitute 56% of the surface area of Antalya Province and 5.4% of our country. 654,870 hectares of these forest areas are productive (57%), while 491,192 hectares are unproductive (43%). Tree species of Antalya Province; It is dominated by maquis,



**Proceeding Book of ISESER 2023**

which can adapt to summer drought, rise to a height of 500/600 meters, and remain green in winter. At altitudes between 600 and 1,200 meters, oak and red pine (65%) are seen, and at higher altitudes, larch (8%) and Aleppo pine are seen. At altitudes between 1,200/2,100 meters, it consists of fir (5%) - cedar (16%) - beech - juniper (4%) and Scots pine. (URL- 2.2).

**2.1.2. Antalya Province Air Quality Measurement Station Information**

In 2021, a total of eight air quality monitoring stations belonging to the Ministry of Environment, Urbanization and Climate Change are in operation in Antalya province, and data is simultaneously sent to the Ministry's Continuous Monitoring Center (SİM) system. The Air Quality Stations available in Antalya city center and the air pollutant parameters measured at these stations are shown in Table 2.1. The locations of the air pollution measurement stations in Antalya are shown in Figure 2.1.

**Table 2.1.** Air pollutant parameters measured at stations

STATION NAME	STATION TYPE	MEASURED AIR POLLUANT PARAMETERS						
		PM <sub>10</sub> (µg/m <sup>3</sup> )	PM <sub>2,5</sub> (µg/m <sup>3</sup> )	SO <sub>2</sub> (µg/m <sup>3</sup> )	CO (µg/m <sup>3</sup> )	NO <sub>2</sub> (µg/m <sup>3</sup> )	NO <sub>x</sub> (µg/m <sup>3</sup> )	O <sub>3</sub> (µg/m <sup>3</sup> )
Antalya-Alanya	heating	X				X		
Antalya-Gazipaşa	rural	X	X	X		X	X	X
Antalya-Kumluca Industry	Urban industry	X	X	X	X	X	X	X
Antalya-Manavgat	heating	X		X		X		X
Antalya-Center	heating	X	X	X	X	X	X	X
Antalya-Muratpaşa	heating	X		X		X	X	
Antalya-Serik	heating	X		X	X	X	X	
Antalya-traffic	Urban traffic	X	X		X	X	X	X

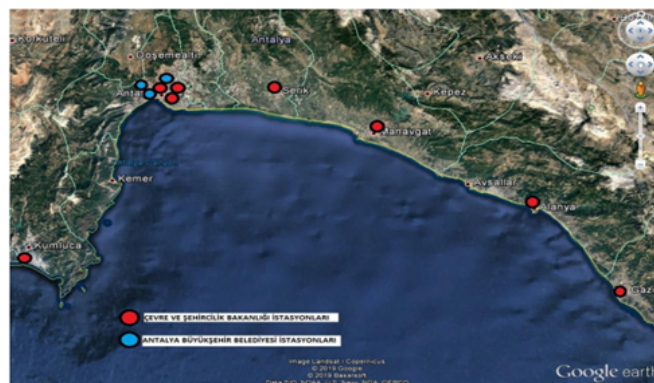

**Figure 2.1.** Locations of air quality measurement stations in Antalya (URL-2.3)

**2.1.3. Devices and Measurement Methods in the Air Quality Measurement Station**

Information about the air quality measurement devices at the stations is as follows.

**• Continuous Particle Matter Measuring Devices**

1. Enviorenment SA MP101M: It is used to determine the amount of dust in the air. A value is obtained by placing a diaphragm between the beta ray reflector and the filter.
2. Thermo 5014i: It continuously measures the mass concentration of particles in the environment.

## **Proceeding Book of ISESER 2023**

3. Metone Bam 1020: It performs PM10 and PM2.5 measurements in accordance with EU standards and EPA standards (URL 2.4).

### **• Particle Matter Measuring Devices**

1. Environnement SA PM162M: Particles at constant flow rate are sampled and collected on filters for gravimetric weighing and physicochemical laboratory analysis.

2. MCZ LVS16: It is a microcomputer controlled device for dust sampling in membrane filters with a diameter of 47-50 mm.

3. LECKEL SEQ 47/50: PM10 and PM2.5 parameters are measured according to the TS EN 12341 measurement method.

4. MCV HVS1: Measurements are made by collecting gas with 140-150 mm diameter membrane filters.

5. Thermo Black Carbon Meter: This device measures light by passing it through a filter and is therefore affected by particle size, shape and distribution of light due to reflection (URL 2.4).

### **• Ozone Measuring Devices**

1. Environment 0341M - O342M - O342e: It is a device that operates on the principle of ultraviolet absorption and continuously measures low concentrations.

2. Thermo 49i: The device measures ozone in the air up to 200 ppm and does this using UV photometric technology.

3. Teledyne T400: It uses a system that measures the low range of ozone in the environment, based on the Beer-Lambert law (directly proportional to the amount of light absorbed) (URL 2.4).

### **• Carbon Monoxide Measuring Devices**

1. Environment SA CO12M - CO12e: It works according to infrared absorption principles and is used to measure carbon monoxide in the atmosphere, especially at low concentrations.

2. Thermo 48i: It is a device that measures the amount of carbon monoxide in the atmosphere between 0-10000 ppm using gas filter technology.

3. Teledyne T300: It measures absorbed infrared energy in low carbon monoxide ranges according to the Beer-Lambert law (URL 2.4).

### **• Nitoxide Measuring Devices**

1. Environment SA AC32M - AC32e: It is used to measure low concentrations of nitrogen monoxide and nitrogen dioxide gases in the ambient atmosphere.

2. Thermo 42i: It is a device that continuously measures nitrogen dioxide and nitrogen oxide parameters in less than five seconds.

3. Teledyne T200: It performs reliable and accurate low-level measurements using the principle of chemiluminescence (a very small amount of light and heat radiation as a result of the reaction) combined with state-of-the-art electronics (URL 2.4).

### **• Sulfur Dioxide Measuring Devices**

1. Environment SA AF22M - AF22e: It continuously measures sulfur oxide based on the principle of measuring fluorescence in ultraviolet rays.

2. Thermo 43i: It measures the amount of sulfur dioxide in the atmosphere up to 100 ppm using UV fluorescence technology.

3. Teledyne T100: It performs reliable, accurate and easy measurements of sulfur dioxide at low concentrations using the UV fluorescence principle (URL 2.4).

### **• International Standards Used in Measurements (URL- 2.5)**

1. For PM10 and PM2.5; The measurement method used in the gravimetric method is: TS EN 12341:2014 and EPA40CFRPART50.

2. For PM10 and PM2.5; The measurement method used in the beta ray absorption method is: TS ISO10473 and EPA40CFRPART50.

3. For O<sub>3</sub>; Measurement method used in ultraviolet photometry method: TS EN14625

4. For NO<sub>2</sub> and NO<sub>x</sub>; Measurement method used in the chemical luminescence method: TSEN14211

5. For SO<sub>2</sub>; Measurement method used in ultraviolet fluorescence method: TSEN14212

## Proceeding Book of ISESER 2023

6. For CO; Measurement method used in wavelength-free infrared spectroscopy (IR Absorption) method: TSEN14626

### 2.2. Method

#### 2.2.1. Modeling and Graphics Program Surfer

It is a modeling program created by Golden software company and used to create grid-based, two-dimensional contour maps and three-dimensional surface maps of scattered data recorded at different points (POLAT, 2002).

□ It visualizes the collected data in high quality in the most accurate way while preserving its sensitivity. It does this by using the XY position and its corresponding Z value.

□ It is a mapping program that performs regularly spaced interpolation of irregularly spaced data with the grid method (It is the development of the deficiency in any series by calculating it with a mathematical method.) (Dursun,2022).

□ It consists of map types with many options such as contour line, three-dimensional surface, color relief.

### 3. RESULTS

As a result of the evaluation made for the fire that occurred in Manavgat district of Antalya Province, which is the area of the thesis study, it was seen that the fire lasted 10 days (July 28 - August 6, 2021) and affected an area of approximately 55 thousand hectares, and approximately 55% of this occurred in the first two days.

Manavgat district covers a residential area of approximately 2,283 km<sup>2</sup> and has a population of 245740. It is adjacent to Serik district in the east, İbradi, Akseki, Gündoğmuş and Alanya districts in the west, and Isparta province is located in the north.

It was determined that the severe northeasterly wind had an impact on the Manavgat district on July 28/29, the average hourly relative humidity decreased to 6% and the air temperature increased to 41°C (MGM, 2021).

Like the fire that occurred in Manavgat District of Antalya Province; A large number of spot fires occur due to the increase in the severity of fires, which start and multiply when the winds are dry and at high speeds and the humidity is very low. This causes the fire to spread and the fire line to expand rapidly. On the first and second day of the fire, settlements, wooded areas and agricultural lands were affected by the severe northerly winds. Pollutants affecting air pollution have dispersed towards the sea under the influence of wind.

The decrease in humidity in the atmosphere and the drying effect of the winds caused the humidity of the dead combustible material to decrease rapidly, and in the calculation (Bilgili et al., 2019), it was determined that the humidity of the combustible material decreased to 3%. In addition, on July 28, the Meteorological Fire Index (MYI) value reached 99 and the day average value was determined as 87 (TOVAG, 2021).

Approximately two days after the fire started, monk and qibla winds started to blow from the south-southeast direction. In the following period, as the relative and flammable material humidity increased and the wind speed decreased, the rate of fire spread decreased.

After the fire was completely brought under control, it was observed that the forest fire caused damage to a total area of 47,824 hectares. As a result of the evaluation, an area of 19,497 hectares, which is 41% of the total burned area, was burned after July 30, 2021. In addition, the areas burned on July 30, 2021 remained within the borders of Manavgat district, and approximately 90% of the total fire area (43,082 ha) took place here. After the fire, it was observed that it had an impact on an area of 511 ha in İbradi district of Antalya and 4,231 ha in Akseki district (Kavzoğlu,2021).

### 4. DISCUSSION AND RECOMMENDATIONS

O<sub>3</sub>; It is not an emission-related pollutant, but its concentration increases due to high radiation levels, especially from the sun. It decreases in closed weather and when air pollution is high.

PM<sub>10</sub>; Since the increase in concentration affects the light path, it can reduce ozone formation. Air quality will increase during low traffic hours and reduction in air pollutants resulting from industrial activity, but ozone will increase as the amount of sunlight reaching the ground increases. It is seen that

### **Proceeding Book of ISESER 2023**

atmospheric PM10 measurement results are not only due to emissions but also depend on meteorological factors (Yahaya, 2022).

PM<sub>2.5</sub>; It is known that the source of pollution is traffic and combustion products, but it should not be forgotten that meteorological factors, especially wind speed, also affect the concentration.

NO<sub>2</sub>; They are emissions from vehicle exhausts, and have also been found to be an important source in industrial facilities (Sağdıç et al., 2022).

It was estimated that air pollution during the fire period was visible and could reach very risky levels for health. However, with the modeling study obtained with measurement data, it has been determined that especially high levels of particulate matter do not have serious health effects when the regulation is based on average values.

Based on this, it has been concluded that the extent of air pollution and its health effects on living beings cannot be fully determined due to the location and small number of stations belonging to the Ministry where air pollution measurements are made.

It is possible to say that the reason why the fire could not be extinguished for a long period of 10 days and spread over a large area was due to the tree species in the region. Because it is known that the wind speed did not reach very high at that time.

### **Recommendations**

- It is known that 56% of the region, which has a temperate climate and high temperatures in the summer, consists of forest areas. It should be taken into consideration that there will be a risk of fire at any time, and our state must take the necessary precautions on this issue, a planning study must be carried out, and the necessary equipment must be available and sufficient to prevent it immediately when a fire occurs.

- It is known that 11% of the causes of forest fires are natural and the other part are human activities. In order to prevent forest fires, the public should be informed, training should be provided on this subject and its importance should be mentioned.

- Although high humidity in the region is a meteorological factor that prevents fire, the decrease in humidity constitutes a reason for fire. Meteorological factors are something that should always be taken into consideration.

- It is important to inform the public about wind speed and direction, which have a great impact on the distribution of air pollution caused by fires.

- In order to obtain more accurate data and take necessary precautions, the Ministry; The number of air quality measurement stations should be increased and spatially distributed.

- Although the ability to extinguish it depends on the plant species in the region, it is necessary to increase the number of green areas and protect them, and it should not be forgotten that in the case of any fire, species are as important as plants.

- Increasing the use of renewable energy resources such as solar and wind; It is seen as an important solution to meet energy needs as well as reduce air pollution (Ulubey et al., 2021).

- Sources of PM10 and PM2.5 content should be identified and their release into the air should be prevented.

- According to WHO, it was concluded that the PM2.5 limit value remained high in the region throughout the year. Legislation needs to be made regarding the PM2.5 limit value, which is not included in the regulation. Additionally, the number of studies on health impact assessment should be increased and attention should be drawn to its importance.

- Antalya province is a touristic region, with the population increasing due to the intense interest in tourism, especially in summer; increase in the number of sea and land motor vehicles, etc. For these reasons, the increase in air pollution is inevitable. This criterion should also be taken into consideration and necessary precautions should be taken to improve air quality.

### **REFERENCES**

- Aydınlı, Güven, Kırksekiz, 2009 “Hava Kirliliği Nedir, Ölçüm Ve Hava Kalite Modelleme Yöntemleri Nelerdir?” Sakarya Üni; 1-2,8-10
- Aydoğan M., 2019 “İstanbul’un Hava Kalitesinin Zamansal Ve Alansal Değerlendirilmesi” Yüksek Lisans Tezi, Atatürk Üni, Erzurum

**Proceeding Book of ISESER 2023**

- Bilgili, E., Coskuner, K.A., Usta, Y., Saglam, B., Kucuk, O., Berber, T., & Goltas, M. (2019). Diurnal Surface Fuel Moisture Prediction Model For Calabrian Pine Stands In Turkey. *İforest - Biogeosciences And Forestry*, 12(3), 262-271. Doi:10.3832/İfor2870-012
- Chandler, C., Cheney, P., Thomas, P., Trabaud, L., Williams, D., 1991, *Fire In Forestry*, Volume:1, Chapter 2, 31-54, U.S.A.,
- Cindoruk S.S. ,2017 “Havadaki No Ve NO2 Parametrelerinin Marmara Temiz Hava Merkezi Ölçümleri Kapsamında İncelenmesi” *Omer Halisdemir University Journal Of Engineering Sciences*, Volume 7, Issue 2, (2018), 600-611
- Dursun Şükrü, :Ijees, 2021, “Evaluation Of Air Quality In Konya City Center After The New Corona-19 Output And With Its Caution”
- Dursun Şükrü, Naseer Qasim Mina, :2022, *Advanced Engineering Science*, “Determination And Modelling Of Pm2.5 Level İn Summer Time İn Selcuk University Shopping Centre Konya, Turkey”
- Dursun Şükrü, Naseer Qasim Mina, 2022, *Advanced Engineering Science*, 2022, “Pm2.5 Concentration Measurements And Mapping At Gokusagi Mall For Autumn 2018, İn Konya, Turkey”
- Dursun Şükrü, Naseer Qasim Mina, 2022 “Measurements And Modelling Of PM2.5 Level İn Summer time Period in Novada Main Shopping Centre Konya, Turkey”:*Engineering Applications*, 19-32
- Dursun Şükrü, Qasim Mina Naseer, 2022:*J. Int. Environmental Application And Science*, “Pm2.5 Level İn Autumn Period Measurements And Modelling İn Novada Mall (Konya, Turkey)” vol 17 (2): 63-74
- Dursun Ş, Sağdıç M, Toros H, 2022, *Informa Uk Limited*, “The İmpact Of Covid-19 Measures On Air Quality İn Turkey”, 23, 1-2, 47-59
- Gül İ., 2018 “Edirne Merkez İlçede Çevre Ve Şehircilik Bakanlığı Hava Kalitesi İzleme İstasyonunda Ölçülen Partiküler Madde 10 (Pm10) Bileşiminin Araştırılması” *Uzmanlık Tezi*, Trakya Üni Halk Sağlığı Anabilim Dalı, Edirne, 1-2
- Kavzoğlu T., 2021 “Orman Yangınları Sebepleri, Etkileri, İzlenmesi, Alınması Gereken Önlemler Ve Rehabilitasyon Faaliyetleri” *Turkish Academy Of Sciences*, Ankara,
- Kırmacı H.K., 2019 “Kahramanmaraş İli İçin Hava Kalitesinin Analizi Ve Modellenmesi” *Doktora Tezi*, Erciyes Üni, Fen Bilimleri Ens., Kayseri
- Kunt Fatma, Dursun Şükrü, 2018 :*Ulusal Çevre Bilimleri Araştırma Dergisi*, “Konya Merkezinde Hava Kirliliğine Bazı Meteorolojik Faktörlerin Etkisi” 54-61
- Lagouvardos, K., Kotroni, V., Giannaros, T. M., & Dafis, S. (2019). Meteorological Conditions Conducive To The Rapid Spread Of The Deadly Wildfire İn Eastern Attica, Greece. *Bulletin Of The American Meteorological Society*, 100(11), 2137-2145. Doi:10.1175/ Bams-D-18-0231.1
- MGM (2021). Antalya, Manavgat 17954 Nolu İstasyon Verisi, T.C. Çevre, Şehircilik Ve İklim Değişikliği Bakanlığı, Meteoroloji Genel Müdürlüğü. Ankara, Türkiye.
- Mihelcic J.R., Zimmerman J. B., 2010. *Environmental Engineering: Fundamentals, Sustainability, Design*. John Wiley & Sons, Inc
- Polat, O., 2002, *Golden Software Surfer V.8 Kullanım İle İlgili Notlar*.
- Qasim Mina Naseer, Dursun Şükrü, 2019 :*Int. J. Of Environ. Poll. Environ. Modell.*, “Measurements Of Ambient Particle Material Level İn Shopping Centers İn Konya City” 37-43
- Tel M., Sağlamtimur N.D., 2019 “Niğde İl Merkezinde Evsek Isınma Kaynaklı Emisyonların Aermod View Hava Kalitesi Modeli Kullanılarak İncelenmesi” *Yüksek Lisans Tezi*, Niğde Ömer Halisdemir Üni, Niğde
- Tovag (2021). *Web Tabanlı Yangın Davranışı Tahmin Sistemi (Ydtweb) (Tovag120o095)*. Türkiye Bilimsel Ve Teknolojik Araştırma Kurumu (Tübitak) Proje Sonuç Raporu.
- Turco, M., Jerez, S., Augusto, S., Tarín-Carrasco, P., Ratola, N., Jiménez-Guerrero, P., & Trigo, R.M. (2019). Climate Drivers Of The 2017 Devastating Fires İn Portugal. *Scientific Reports*, 9(1), 13886. Doi:10.1038/S41598-019-50281-2
- Ulubey Aydın, Gusev Aleksandr, Dursun Şükrü, Toros Hüseyin, Hadziç Majda, Yayın Yeri: *Environmental Aspects Of Energy*, 2021, “Evaluation Of Air Quality (Carbon Monoxide) In Megacity İstanbul”
- Url-1.1 Particulate Matter Pollution. [İnternet]. Epa (Erişim Tarihi: 05.01.2022); Available From: <https://www.epa.gov/pm-pollution/particulate-matter-pm-basics#pm>
- Url-1.2 Ground-Level Ozone Basics. [İnternet]. Epa (Erişim Tarihi:01.06.2022) Available From: <https://www.epa.gov/ground-level-ozone-pollution/ground-level-ozone-basics#effects>

**Proceeding Book of ISESER 2023**

Url-2.1 Erişim Tarihi: (11.05.2022) [https://tr.wikipedia.org/wiki/antalya#cite\\_note-3](https://tr.wikipedia.org/wiki/antalya#cite_note-3)

Url-2.2 Erişim Tarihi: 12.05.2022 [https://webdosya.csb.gov.tr/db/ced/icerikler/antalya\\_2020\\_-cdr-20210812095503.pdf](https://webdosya.csb.gov.tr/db/ced/icerikler/antalya_2020_-cdr-20210812095503.pdf)

Url-2.3 Erişim Tarihi: 15.02.2022 [https://webdosya.csb.gov.tr/db/ced/icerikler/antalya\\_cdr\\_2019\\_son-20200907101243.pdf](https://webdosya.csb.gov.tr/db/ced/icerikler/antalya_cdr_2019_son-20200907101243.pdf)

Url- 2.4 Erişim Tarihi 14.06.2023 <https://havakalitesi.ibb.gov.tr/Icerik/hakkimizda/olcum-cihazlari>

Url- 2.5 Erişim Tarihi 14.06.2023 <https://havakalitesi.ibb.gov.tr/Icerik/hakkimizda/olcum-yontemleri>

Url-2.6 Erişim Tarihi: 15.03.2023 <https://support.goldensoftware.com/hc/en-us/articles/231348728-a-basic-understanding-of-surfer-gridding-methods-part-1>

Yahaya Noor Zaitun, Jalaludin J, Toros Hüseyin, Dursun Şükrü, 2022, Yayın Yeri:Iop Conference Series: Earth And Environmental Science,”Air Quality Status İn Konya City Centre, Konya, Turkey During Pandemic Covid-19”

**O 3. EVALUATION OF SPATIAL SUSTAINABILITY ON THE IMPORTANCE OF WALKABILITY IN CHOOSING THE LOCATION OF HOTELS IN THE CITY OF KONYA**

Musa Kazım Argun<sup>1\*</sup>, Çiğdem Çiftçi<sup>1</sup>, Laura Shumka<sup>2</sup>

<sup>1</sup>*Department of City and Regional Planning, Necmettin Erbakan University, Konya, Turkey*

<sup>2</sup>*Barleti University, Faculty of Architecture and Design, Tirana*

E-mail: [mkazimargun@rbakan.edu.tr](mailto:mkazimargun@rbakan.edu.tr), [cigdemciftci@erbakan.edu.tr](mailto:cigdemciftci@erbakan.edu.tr), [shumkalaura@gmail.com](mailto:shumkalaura@gmail.com)

**ABSTRACT:** Formation of compact and sustainable societies and cities under the influence of various political initiatives and social awareness is one of the basic principles of today's city planning. In society, there is a prevailing opinion that economic costs must be paid in order to ensure sustainability in the environmental and social context. On the other hand, in various scientific studies, it has been revealed that sustainability policies provide economic benefits to users from building scale to city and regional scale and produce economic value. While walkability is the most basic indicator of sustainability on urban scale, it will reduce the ecological footprint of cities and minimize fossil fuel dependence with a city approach that prioritizes compact city form instead of today's widespread cities with uncertain borders. With this pedestrianization-based planning approach, which reduces automobile dependency, the prevention of cities' uncontrolled growth and the development of spatial theories compatible with human scale, based on traditional city forms such as 15-minute walk city has been enabled. Studies conducted in various countries, including Turkey, show that there is a strong correlation between walkability with real estate investments and various other economic indicators. In this study, it will be examined to what extent the walkability criteria are taken into account in the selection of the locations of the hotels as touristic accommodation facilities in accordance with the compact-walkable city planning principles in the sample of the city of Konya, and to what extent the tourists staying in the city for congress, historical and religious tourism choose hotels by taking into account the walkability criteria, considering that in the city concept all urban social facilities are offered in the city center and the historical city center is located next to this developed center in spatial context. The degree of correlation of these two parameters in the context of walkability will contribute to the spatial sustainability of the city of Konya by shedding light on the compactness data set that should be related to the future of Konya city. In addition, by defining the relationship between the study outputs, walkability values and the accommodation preferences of the tourists, it will guide the tourism investors who will invest in the city to choose a new accommodation facility.

*Keywords: Compact City Planning, Sustainability, Walkability, Hotel Location Selection, Konya*

**O 4. OBSTACLES TO AQUATIC ECOLOGY AND WATER CORRIDORS AS PART OF  
CLIMATE-ADAPTIVE SOLUTION TO A COMPLEX PROBLEM**

Spase Shumka<sup>1</sup>

<sup>1</sup>*Faculty of Biotechnology and Food, Agricultural University of Tirana, Koder Kamza, Tirana 1000,  
Albania*

E-mail: [sprespa@gmail.com](mailto:sprespa@gmail.com); <https://orcid.org/0000-0001-5336-1174>

**ABSTRACT:** This article is based on long-term research approaches on fish and associated aspects of River Drini (including both Black and White Drini). It was dealing with habitats and aquatic species with focus water connectivity at the landscape contexts. Biodiversity and particularly native fish populations and particularly endemic fish species in the Drini river system (all littoral countries) are threatened by several anthropogenic activities and factors like: (i) Water pollution caused mostly due to a lack of the waste water treatment facilities as well as a lack of integrated management approaches; (ii) Relatively unregulated fishery practices and illegal fishing, use of destructive methods of fishing; (iii) Non native fish species, accelerated abundance with unpredicted sequences to native endemic species; (iv) Impacts on specific spawning grounds for specific species particularly due to serious impacts caused by water use in the agriculture sector with a constant presence of run-offs and no abatement plans; (iv) Poor integration of fishery management practices into the entire management of the area (including protected one as Nature Park Korrab-Koritnik, etc) which is recognized internationally for its rich biodiversity and abundance of species, proclaimed as an important area for the conservation of European species and habitat., and IBA; (v) Low rate of local awareness for the fish biodiversity, conservation threats. The awareness and knowledge is just limited to a couple of commercial fish species.

The fish assemblage of Black Drini River is rapidly changing and similarly to wider Mediterranean area it is expected that will follow in a situation of increased anthropogenic impacts and climate changes by the introduction of alien species. Being situated at the proximity with connected Lakes, neighboring one and associated tributaries and systems where the assemblages are rapidly changing, there is a relatively a high risk of changes regarding the composition and share. In our case with alien species, we have to consider both exotic ones and those translocated from other ecoregions.

*Keywords: Landscape, Ecological Connectivity, Aquatic Species, Conservation, Water Quality*



**O 5. THE SPATIOTEMPORAL IMPLICATIONS OF URBANIZATION FOR URBAN HEAT ISLANDS (UHI) IN TIRANA UNDER THREATENING EXTREME SUMMER TEMPERATURES**

Laura Shumka<sup>1\*</sup>, Çiğdem Çiftçi<sup>2</sup>, Musa Kazım Argun<sup>2</sup>, Kimete Tataveshi<sup>3</sup>, Andi Papastefani<sup>1</sup>

<sup>1</sup>*Barleti University, Faculty of Architecture and Design, Tirana*

<sup>2</sup>*Department of City and Regional Planning, Necmettin Erbakan University, Konya, Turkey*

<sup>3</sup>*Albanian University, Faculty of Applied and Economic Science, Department of Engineering, Tirana*

E-mail: *shumkalaura@gmail.com; arch.co@umb.edu.al, cigdemciftci@erbakan.edu.tr, mkazimargun@rbakan.edu.tr, k.tataveshi@albanianuniversity.edu.al, a.papastefani@albanianuniversity.edu.al*

**ABSTRACT:** The rapid urbanization of the last three decades in Tirana (capital city of Albania) has adverse environmental effects, such as rising surface temperatures. This article analyzes the relationship between the urban heat island (UHI) intensity and Tirana city's land cover characteristics facing serious changes with reduction of green areas. This analysis is based on the temperature data (air and land surface) covering period of 10th to 31st July 2023. The heat islands are clearly defined and there is visible relationship among air and land surface temperature along with green area presence vs. absence. The survey has been based on build up areas (three sample locations), green area, and forest and water bodies. While temperature difference among green/forest/water area and asphalt covered one was 1.5-2.7°C, the difference among air and land temperature in asphalt covered zones was in between 2-3.8°C. For understanding the linkage of the average temperature and built-up percentage, a correlation coefficient analysis was undertaken on each sample area. Following data analyses, we found out that the average temperature and the built-up percentage has a moderate correlation of  $R^2 = 0.54$ . The increase and differences in the land surface temperature caused by the land cover change is a strict argument that the site is becoming quickly urbanized. In addition to similar approaches further studies should be oriented into the public health issues linked with rapid urbanization.

*Keywords: Extreme Weather, Land Surface Temperature, Urban Heat Island, Land Use Cover Change, Urban Planning, Ecological Features.*

**O 6. GEOLOGY AND HYDROCHEMICAL CHARACTERISTICS OF THE AKHÜYÜK  
SPRING (EREĞLİ-KONYA) AND ITS HOT MINERAL WATERS**

Constantin Tonkeu Dipankeu<sup>1\*</sup>, Guler Gocmez<sup>1</sup>, Osman Pasha<sup>1</sup>

<sup>1</sup>*Department of Geological Engineering, Faculty of Engineering and Natural Sciences, Konya  
Technical University*

E-mail:

**ABSTRACT:** The Akhüyük Spring is located 150 km from Konya province and 9 km from the Ereğli district. In 2023, it was registered as a Natural Site, and investments made by the Ereğli Municipality aim to develop it for thermal tourism and contribute to the regional economy. The study area comprises Tertiary and Quaternary rock formations. The base is formed by the Oligocene-aged Tapir Formation, overlain unconformably by Quaternary alluvium and travertine deposits consisting of dolomitic limestone, anhydrite, gypsum, alluvial gravel, sand, clay, and silt. The hot and mineral waters of Akhüyük emerge along the Akhüyük Fault, with temperatures ranging from 21-28°C and discharge rates between 0.16 - 0.45 L/s. Waters from boreholes have temperatures of 10 - 13°C and discharge rates between 0.05 - 0.32 L/s. These hot mineral waters have a meteoric origin. When they reach the surface along the Akhüyük Fault, the decrease in pressure causes CO<sub>2</sub> gas to escape, leading to the precipitation of CaCO<sub>3</sub>. Carbonate deposition occurs in both directions along the fault, resulting in the formation of a travertine cone with two pointed ends in the NW-SE direction. Two artesian wells are drilled on the axis of the travertine cone. However, these artesian wells have depleted many springs along the Akhüyük Fault. The aquifer for hot mineral waters consists of limestone from the Tapir Formation. The hot mineral waters are saturated with calcite, dolomite, aragonite, anhydrite, and gypsum minerals. According to the semi-logarithmic Schoeller diagram, hot mineral waters and borehole waters have different origins. Based on the Piper diagram, the waters fall into the Zone 5 category, characterized by waters with over 50% carbonate hardness, mainly CaCO<sub>3</sub> and MgCO<sub>3</sub>. According to the Wilcox diagram, Akhüyük spring waters are unsuitable for drinking, while borehole waters are of good quality and suitable for use. According to the U.S. Salinity Laboratory diagram, hot mineral waters fall into category C4S1, indicating they are highly saline and low in sodium.

*Keywords: Spring, Hot Mineral Water, Geothermal Gradient, Travertine Cone, Akhüyük Fault*

**O 7. THE EVALUATION OF THE SNOW CLIMATE INDICATOR IN SOME AREAS OF ILLINOIS, USA**

Hysen Mankolli<sup>1</sup>

<sup>1</sup>*Independent Environment Researcher, Illinois, USA; Editor of IJEES, Health and Environment Association, Illinois, USA*

E-mail: [hysenmankolli@yahoo.com](mailto:hysenmankolli@yahoo.com)

**ABSTRACT:** The Chicago area there are in the south-eastern of Lake Michigan in the north of Illinois State with climatic influences from Lake Michigan. The data obtained refer to the stations Chicago, Freeport, Rockford, Kenosha, Aurora, Gary, Joliet, Ottawa, Dixon, Clinton, Dekalb, Kankakee, Pontiac, Peoria, Bloomington. The climate of the Chicago Area is with cold winters and scattered snowfall in the winter months. The study shows some estimates of snowfall trends over a multi-year period. Data refers to reports from the National Oceanic and Atmospheric Administration National Weather Service, Chicago, IL, 333 West University Drive, Romeoville, IL. The analysis of snow precipitation amount data is based on the application of the mathematical method Excel. The results show that precipitation values are different over the years. Trends are given by regression equations. For January 1985-2021:  $y = 4.4576x + 1937.5$ ,  $R^2 = 0.0378$ . The tendency of the value of snowfall for the months of January is with a constant 4.4576. In the period Seasonal Snowfall Totals for Chicago from 1884 to 2021:  $y = 2.3353x + 1890.2$ ,  $R^2 = 0.0868$ . The tendency of the value of snowfall for each year period is with a constant 2.3353. The smallest amount of snow precipitation is estimated for the years 1920-1921 with 9.8 inches. The highest amount of snow precipitation is estimated for the years 1978-1979 with 89.7 inch. All result are based on statistical method. Our statewide snowfall records in Illinois start in 1902. There is no long-term trend in snowfall since 1902. However, some decades were snowier than others, such as the 1910s, 1960s, and 1970s. In fact, the 1970s were the snowiest decade on record with an average snowfall of 27.2 inches. Snowfall amounts dropped steeply with less year to year variability for much of the 1980s and into the early 2000s. However, snowfall amounts in the last 6 winters have been more variable with the winter of 2014 being about as snowy as the late 1970s. The snowiest winter on record was 1979 with 44.5 inches. Here are the 5 snowiest winters on record: 1979 with 44.5 inches; 1978 with 44.4 inches; 1912 with 39.5 inches; 2014 with 39.4 inches; 1960 with 38.6 inches; Snowfall is accumulated from July 1 of the first year to June 30 of the second year. The second year is used in the plot and table (for example, 2006 refers to the 2005-2006 season, source: state climatologist Illinois).

*Keywords: Data Snow, Evaluation, Snow Climate Indicator, Areas of Illinois, USA*

*Acknowledgement. This paper has been prepared a part of independent Study CLIMATIC DATA AND SNOW DEPTH IN SOME REGIONS AT USA AND ALBANIA, project 2022 no. 02012022.*

*Conflicts of interest. The authors declare no conflicts of interest.*

## **1. MATERIALS AND METHODS**

Total snowfall has decreased in many parts of the country since widespread observations became available in 1930, with 57 percent of stations showing a decline (see Figure 1). Among all of the stations shown, the average change is a decrease of 0.19 percent per year.

In addition to changing the overall rate of precipitation, climate change can lead to changes in the type of precipitation. One reason for the decline in total snowfall is because more winter precipitation is falling in the form of rain instead of snow. Nearly 80 percent of the stations across the contiguous 48 states have experienced a decrease in the proportion of precipitation falling as snow (see Figure 2).

Snowfall trends vary by region. The Pacific Northwest has seen a decline in both total snowfall and the proportion of precipitation falling as snow. Parts of the Midwest have also experienced a decrease, particularly in terms of the snow-to-precipitation ratio. A few regions have seen modest increases, including some areas near the Great Lakes that now receive more snow than in the past (see Figures 1 and 2).

Proceeding Book of ISESER 2023

Study area and collected data



Fig 1. The areas collected data, Illinois.

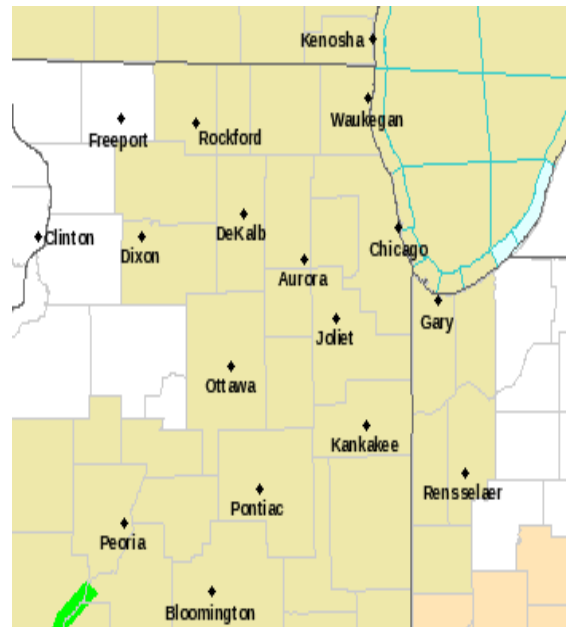

Fig 2. Analysing data

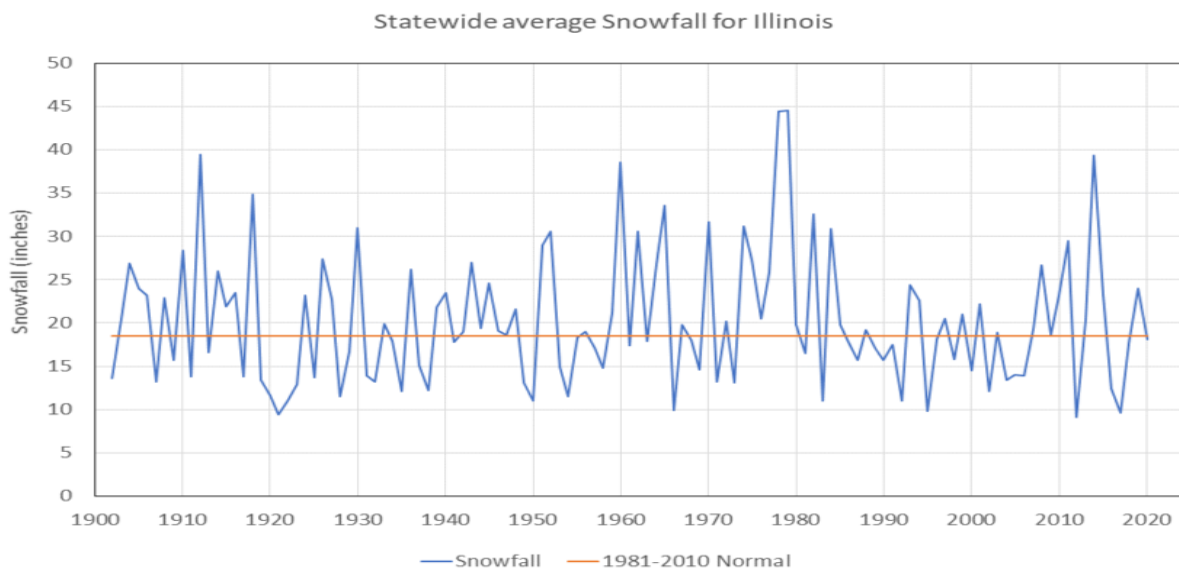

Fig 3. State climatologist Illinois. Source: <https://stateclimatologist.web.illinois.edu/snowfall-trends/>

## 2. RESULTS

The analysis of snow precipitation amount data is based on the application of the mathematical method Excel. The results show that precipitation values are different over the years. Trends are given by regression equations. For January 1985-2021:  $y = 4.4576x + 1937.5$ ,  $R^2 = 0.0378$ . The tendency of the value of snowfall for the months of January is with a constant 4.4576. In the period Seasonal Snowfall Totals for Chicago from 1884 to 2021:  $y = 2.3353x + 1890.2$ ,  $R^2 = 0.0868$ . The tendency of the value of snowfall for each year period is with a constant 2.3353. The smallest amount of snow precipitation is estimated for the years 1920-1921 with 9.8 inches. The highest amount of snow precipitation is estimated for the years 1978-1979 with 89.7 inch. All result are based on statistical method. Our statewide snowfall records in Illinois start in 1902. There is no long-term trend in snowfall since 1902.

## 3. CONCLUSIONS

- Some decades were snowier than others, such as the 1910s, 1960s, and 1970s. In fact, the 1970s were the snowiest decade on record with an average snowfall of 27.2 inches.
- Snowfall amounts dropped steeply with less year-to-year variability for much of the 1980s and into the early 2000s. However, snowfall amounts in the last 6 winters have been more variable with the winter of 2014 being about as snowy as the late 1970s.
- The snowiest winter on record was 1979 with 44.5 inches. Here are the 5 snowiest winters on record: 1979 with 44.5 inches; 1978 with 44.4 inches; 1912 with 39.5 inches; 2014 with 39.4 inches; 1960 with 38.6 inches.
- Snowfall is accumulated from July 1 of the first year to June 30 of the second year.
- The second year is used in the plot and table (for example, 2006 refers to the 2005-2006 season, source: state climatologist Illinois).

## REFERENCES

- Anderson, E.A. (1976), A Point Energy and Mass Balance Model of a Snow Cover, NOAA Technical Report NWS 19, 150 pp., U.S. Dept. of Commerce, Silver Spring, Maryland;
- Brasnett, B., 1999: A global analysis of snow depth for numerical weather prediction. J. Appl. Meteor., 38, 726-740;
- Cezar Kongoli<sup>12</sup>, 2015. OPTIMAL INTERPOLATION OF IN-SITU AND SATELLITE PASSIVE MICROWAVE DATA FOR GLOBAL SNOW DEPTH ESTIMATION, International Journal of Ecosystems and Ecology Science (IJEES): Vol. 5 (4): 637- 642 (2015);

**Proceeding Book of ISESER 2023**

- Cezar Kongoli<sup>12</sup>, 2016. LARGE - SCALE SNOW DEPTH – ELEVATION RELATIONSHIPS OF WORLD’S MAJOR MOUNTAIN REGIONS, *International Journal of Ecosystems and Ecology Science (IJEES)*: Vol. 6 (4): 653-658 (2016);
- Cezar Kongoli<sup>12</sup>, Robert J. Kuligowski<sup>2</sup>, Sean Helfrich<sup>2</sup>, Peter Romanov<sup>32</sup>, 2014. MONITORING PRECIPITATION AND SNOW COVER USING MULTI-SENSOR SATELLITE AND IN-SITU DATA, *International Journal of Ecosystems and Ecology Science (IJEES)*; Vol. 4 (2): 293-300 (2014);
- Cezar Kongoli<sup>12</sup>, Sean Helfrich<sup>2</sup>, Robert J. Kuligowski<sup>2</sup>, 2015. SATELLITE-BASED ESTIMATION OF HYDROLOGIC COMPONENTS – APPLICATION TO SNOW AND PRECIPITATION, *International Journal of Ecosystems and Ecology Science (IJEES)*: Vol. 5 (2): 261- 268 (2015);
- Cezar Kongoli<sup>12</sup>, Yu Zhang<sup>3</sup>, Zhengtao Cui<sup>42</sup>, Robert J. Kuligowski<sup>2</sup>, 2017. ESTIMATION OF SNOW AND RAINFALL FOR HYDROLOGICAL ANALYSIS OF A MID-WINTER FLOODING EVENT IN WESTERN UNITED STATES, *International Journal of Ecosystems and Ecology Science (IJEES)*: Vol. 7 (4): 651-656 (2017);
- Hall, D.K. and G.A. Riggs, 2007. Accuracy assessment of the MODIS snow-cover products, *Hydrological Processes*, 21(12):1534-1547, DOI: 10.1002/hyp.6715;
- Hall, D.K., G.A. Riggs, V.V. Salomonson, N.E. DiGirolamo and K.A. Bayr, 2002. MODIS snow-cover products, *Remote Sensing of Environment*, 83:181-194;
- Hysen Mankolli<sup>12</sup>, Andi Mankolli<sup>3\*</sup>, 2017. SNOW AND RAIN PRECIPITATION IN SOME REGIONS OF ALBANIA, *International Journal of Ecosystems and Ecology Science (IJEES)*: Vol. 7 (3): 645-650 (2017);
- Kongoli, C. and S. Helfrich, 2015. [A multi-source interactive analysis approach for Northern hemispheric snow depth estimation](#), *Proceedings of the Geoscience and Remote Sensing Symposium (IGARSS)*, IEEE International, Milan, Italy, DOI: 10.1109/IGARSS.2015.7325878;
- Kongoli, C. E. and Bland, W. L. (2000): Long-term snow depth simulations using a modified atmosphere-land exchange model, *Agr. Forest Meteorol.*, 104, 273–287;

**O 8. THE EVALUATION OF RECREATIONAL AREAS IN TERMS OF ECOLOGICAL-CULTURAL TOURISM**

Bahriye GÜLGÜN<sup>1</sup>, Atakan PIRLI<sup>2</sup>, Kübra YAZICI<sup>3\*</sup>, Funda ANKAYA<sup>4</sup>

<sup>1</sup>*Ege University, Faculty of Agriculture, Landscape Architecture, Department, İzmir Bornova, e-mail: bahriye.gulgun@hotmail.com*

<sup>2</sup>*Ege University, Faculty of Agriculture, Graduate School of Natural and Applied Sciences, İzmir Bornova, e-mail: atakanpirli@gmail.com*

<sup>3</sup>*Yozgat Bozok University, Faculty of Agriculture, Landscape Architecture, Department, Yozgat, Merkez, e mail: k-yazici-karaman@hotmail.com.*

<sup>4</sup>*Manisa Celal Bayar University, Alaşehir Vocational School, Landscape and Ornamental Plants Program, 45600 Alaşehir/Manisa. fundaunalankaya@hotmail.com*

E-mail: *k-yazici-karaman@hotmail.com*

**ABSTRACT:** Tourism is the fastest developing and fastest growing industry in the world and has become one of the fields of social sciences. Lately, cultural tourism phenomena have gained importance in the field of tourism worldwide. Belief and art have a significant place in the concept of ecological-cultural tourism. Eco-cultural tourism is the combination of the ecological and cultural components of a landscape. This study aimed as a way to develop marginal cultures and natural resources. Sustainability is a significant factor for the long-term future of tourism. The principles of ecotourism, which carry all the principles of sustainability, and cultural tourism, where different and current practices of cultures are evaluated together, form the basis of the concept of eco-cultural tourism. The most significant element is to ensure sustainability in the eco-cultural tourism approach, development for local control of planning, and maintenance of the areas. In this study, the first step is to observe and define the relationship of the local community with its environment. Eco-cultural tourism is a model of ecotourism and cultural tourism that employs local people. In this study, belief and art were evaluated from the perspective of cultural tourism and ecotourism, and examples within the scope of ecological cultural tourism were evaluated.

*Keywords: Tourism, Ecotourism, Eco-Museums, Landscape*

**1. TOURISM AND CULTURAL TOURISM**

Tourism is a set of social activities that arise in line with the need for spiritual, physical, and physical renewal (Gülgün et al., 2014a; Gülgün et al., 2014b; Akpınar Kulekçi et al., 2020; Yazici and Aşur, 2021; Gülgün et al., 2019). Tourism is a whole consisting of various subsystems. Geography has an important effect on the tourism sector because both tourist and host areas are geographical areas. In other words, places such as countries, regions, regions and cities where tourism demand arises are parts of geographical areas. In these areas, natural and cultural attractions, facilities, services, and tourism organizations constitute tourism factors. Thus, tourism is primarily located in a physical (geographical) environment. This physical environment also affects the human environment (Soykan, 2000; Pirlı and Yazici, 2022; Yazici et al., 2017). In other words, Cultural tourism is a trip made to participate in art activities such as festivals, folklore, theatre, and exhibitions, to get to know past and living civilizations and cultural values, and to see historical places and lifestyles of the society (Aydın, 1990; Gülgün et al., 2017; Yazici et al., 2018; Yazici and Gülgün, 2019 Aşur and Yazici, 2020). Cultural tourism, which has developed as a result of tourists' interest in cultural heritage, has started to develop with historical places, museums, historical ruins, fairs, and festivals. Along with the remains of past civilizations, lifestyles, traditions, customs, festivals, music and entertainment types, handicrafts, food types, and habits are becoming increasingly significant in the globalizing world among the most important products of cultural tourism. However, not every cultural product, museum, or historical site can create a distinct tourist attraction. Turning cultural attraction into a touristic product requires creating an image and brand, planning, and promotional activities. Cultural attractions constitute the basis of cultural products (Emekli, 2006).

Religious tourism is defined as the visit to holy places by tourists belonging to various religions within the phenomenon of tourism. Studies started in 1995 on religious tourism in Turkey and "religious tourism" was organized between 1995 and 1998 with the participation of foreign tour companies, press members, clergy, and relevant experts. In Anatolia, there are significant visit centers for religious tourism belonging to Islam (such as "Holy Relics" in Topkapı Palace, Eyüp Sultan Mosque, Süleymaniye Mosque, Selimiye Mosque in Edirne, Mevlana Tomb in Konya, etc.), Christianity (Ephesus, Iznik, Antakya, Istanbul, etc.) and Judaism (Şanlıurfa, Hatay) (Sargin, 2006). Religion is both a historical and a contemporary phenomenon. In almost all living religions, certain times of the year take time for ritual worship. For example, the collective worship is to cleanse their sins in the waters of the Ganges River in the Hindu religion. the Christmas worship in the Vatican, which lasts for a week starting from December 24 under the Pope's administration, and the collective worship of Muslims in Mecca on the Feast of Sacrifice are worships that have reached universal dimensions. The dependence of worship on the place directs people to that place, and thus heavenly places create tourism attraction (Koçoğlu, 2006).



**Figure 1.** The 2,704 km long Hganj River flows through the northern territory of India and Bangladesh, India, (Access 1)

## **2. CULTURAL TOURISM ACCORDING TO BELIEFS**

### **2.1. Judaism**

In Judaism, the dates of holidays and mourning days are arranged according to the Jewish calendar. The most significant holiday is Rosh Hashanah or New Year's Day. This day is followed ten days later by a twenty-six-hour fasting day called Yom Kippur, which means the Day of Atonement. After Kipur, there is Sukkot, the Feast of Tabernacles, which lasts seven days, Simhat Torah, when the reading of all the chapters of the Torah is completed and resumed within a year, Hanukkah in December, and Purim, which lasts two days from March to April, commemorating Esther's last-minute prevention of the massacre of the Jews in Babylon by the anti-Semite Haman, an enemy of the Jews at the time, Significant days include Shavuot, which commemorates the liberation from slavery after leaving Egypt under the leadership of Moshe Rabenu, and Tisha Be'av, which falls in the summer and commemorates the destruction of the Temple and various unfortunate events.



**Figure 2; Figure 3.** Purim Feast Sample Image - Feast of Tabernacles Sample Image (Access 2; Access 3)



**Proceeding Book of ISESER 2023**

**2.2. The Christian**

Christianity is not a new religion for Turks. Since the early days of Christianity, Turks have encountered the faith of Jesus in various periods and have become Christians. The word called Christian was first used in Antioch in the 40s AD. As it is known, this faith, which developed in the Middle East about two thousand years ago, first spread in Anatolia, a part of our homeland. Later Christianity spread to Thrace and Europe.

Many places in Turkey are considered sacred for the Christian world. Today, some pilgrims come here from the Vatican. On the feast day, November 1, patients organize a big ceremony in the church and pray until the morning. St. Paul Well water was believed to be healing in Tarsus. Today, this well water, which attracts great interest from tourists, is believed to be sacred (Sinha, 2009).



**Figure 4; Figure 5.** The First Church of the World, St. Pierre Church - St. Paul Well Water Image, (Access 1; Access 3)

**2.3. Islam**

Islam is the youngest of the world's great religions. Its prophet is the Prophet Muhammad. Like other great religions, Islam is centered in the Middle East and has influenced various countries, cultures, and nations in a widespread geography. Apart from Arabs, Turks, Persians, and Hindus are the main nationalities that adopted Islam. Since the adoption of Islam by the Turks coincided with the migration and conquest movement of the Turks towards the West, the Turks were the nation that introduced and brought Islam to Europe and the West. The cornerstones of Turkish Islam, the emergence of a Turkish-specific understanding and difference of belief, is based on the Sufi generation symbolized by the philosophy of Yesevi, Hacı Bektaş, Mevlana, and Yunus. Here, unlike the Middle Eastern roots of the great religions, the Turkish understanding of Islam is based not on the fear of God and discipline of grind, but on the love of God and an enthusiastic embrace of all life and nature.

The Great Mosque where is Diyarbakır/Türkiye, known as the fifth Harem-i Sharif in the Islamic world. This first Islamic structure, which has significant value in terms of the fountains in its courtyard and inscriptions from various periods, was built with black stones. Ulu Cami, the oldest mosque in Anatolia, is similar to the Ummiye and Umayyad mosques in Damascus. Eshab-ı Khef Cave in Tarsus. This cave is mentioned in the Quran and is considered sacred for Muslims (Sinha, 2009). After the settlement of the Turks in Anatolia, Konya became one of the settlements that had a big impact on the establishment and spread of Turkish culture and civilization in Anatolia. The Turks left many mosques, madrasahs, inns, museums, and other works of tourism potential in Konya and its surroundings belonging to the Seljuk, Principalities, and Ottoman periods.

Mevlana (1207-1273), one of the most significant scholars of his time, and his family came to Konya during the reign of Alaeddin Keykubat. Mevlana's influence on Konya and Turkish culture, his way of life, his philosophy of life, and his worldview shed light on a wide environment today as it did in his time. Likewise, scholars such as Nasrettin Hodja, Shamsi Tabriz-i, Kadı Burhaneddin, and Sadrettin Konevi lived in Konya and left their works.

Within the scope of cultural and faith tourism in Konya province, international Mevlana Commemoration Ceremonies (December 01-17), Konya Lovers Festival, Nasreddin Hodja Festival, Beyşehir Tourism Festival, Industrial and Export Products Fair and social, cultural and scientific activities such as congresses, symposiums, seminars and panels organized by various institutions and

**Proceeding Book of ISESER 2023**

organizations such as Selçuk University, Konya Governorship, Provincial Directorate of Tourism, Metropolitan Municipality (Tanpur, 2009).



**Figure 6; Figure 7: Konya Karatay Madrasa- Konya Karatay Madrasa (Access 4; Access 5)**

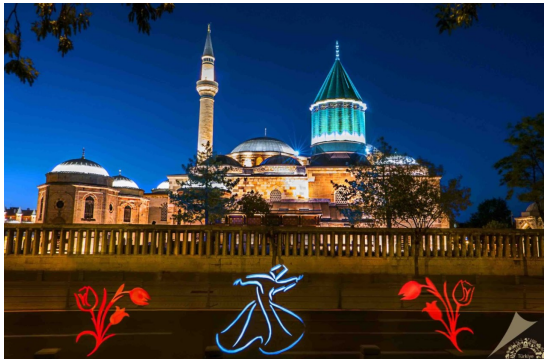

**Figure 8; Figure 9: Ince Minareli Madrasa, Konya- Mevlana Museum, Konya**



**Figure 10; Figure 11. Nasreddin Hodja Festivities, Konya- Sille Aya Eleni Church, Konya, (Access 6)**

Cultural tourism is based on the synthesis of places, traditions, artistic activities, customs, and experiences that reflect the character of the local people (Sinha, 2009). The concept of learning about other cultures to enhance one's perspective is often a core value. When a tourist is interested in a tradition through the purchase of traditional clothing from the artisans of a region, this is considered a dimension of cultural tourism. The exchange with an artisan is more than just the exchange of money; it is the goal of cultural tourism to create a mutual interaction. Successful cultural tourism projects depend on cooperation, evaluation, research, marketing, and a developed service sector for visitors.

### **3. ECOLOGICAL-CULTURAL TOURISM**

Eco-cultural tourism combines the ecological and cultural components of a landscape. This concept is proposed to develop marginal cultures and natural resources. The most significant element in the eco-cultural tourism approach is to ensure the sustainability of local control in the planning,

**Proceeding Book of ISESER 2023**

development, and maintenance of areas. Observing and defining the relationship of the local community with its environment is the first step to achieving this. Eco-cultural tourism is a model of ecotourism and cultural tourism that employs local people (Pociovalisteanu and Niculescu, 2010).

Within the scope of eco-cultural tourism, which is defined as an environmentally sensitive and sustainable form of tourism, the concept of 'ecomuseum', which protects and preserves the natural and cultural environment together, comes to the fore. Unlike classical museology supported by the presentation of objects in a closed space, ecomuseums are founded a holistic approach that includes the combination of local character and local resources. In an ecomuseum, there are antenna units that provide information transfer with the center. These antenna units include service units (thermal facilities if there is a hot water source, etc.), observation points, etc. according to the theme of the ecomuseum. These units are connected by walkways.

The concept of eco-museum is founded on the principle of integrating the cultural heritage left by past societies with the natural landscape of the region. For this reason, it is possible to say that ecomuseum applications have all the qualities of the cultural landscape.

The concept of ecomuseum is based on a critical awareness and interpretation of the historical development of man in the modern world and his approaches to the future.

The first ecomuseum was established in a national park in the late 1960s. It is an area spatially structured with a museum structure called the 'Museum of Time', a permanent exhibition space depicting the history of the region, and connecting roads into the park. The main goal of the ecomuseum is to preserve the rural structures and landscape in situ and to ensure the continuity of traditional, agricultural, and rural activities (Pressenda and Sturani, 2007).



**Figure 12.** Creusot Montceau Les-Mines Ecomuseum, (Access 17)

At the ICOM meetings held in 1971-1972, the Creusot-Montceau Les-Mines Ecomuseum in France was the first application to be known as an 'Ecomuseum'. At the end of the 18th century, Le Creusot-Montceau region, which was a brand in the fields of ceramics, glass, steel industry, and transportation, was established as an ecomuseum in 1973 to protect, develop, and catalog the cultural and industrial heritage of the region. In the same area, there is also a Fossil Museum where vegetation and animal remains from 300 years ago are presented Le Creusot-Montceau-les-Mines Ecomuseum shows a regional organization with the inclusion of structures defined as units such as various production areas related to industrial and agricultural activities, as well as open spaces, sightseeing routes, natural areas, rather than a museum created within a single building.

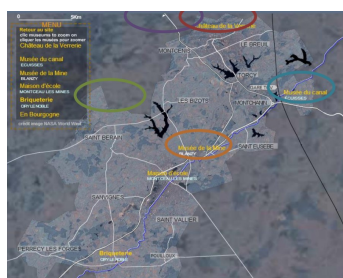

**Figure 13.** Plan of Le Creusot-Montceau-les Mines Ecomuseum, (Tuna and Erdoğan 2013)



**Figure 14.** Le Creusot-Montceau-les Mines Ecomuseum Glass Castle; In the museum where industrial heritage is shown, especially products made of glass are shown (Tuna and Erdoğan 2013)

When we look at the landscape concept of the ecomuseum, we see that it includes different themes. In particular, Le Château de la verrerie (The Glass Castle) has a bosque-style planting in the classic French formal gardens designed around Le Musée du canal, à Écuisses and La Briqueterie, à Ciry-leNoble. Sidewalks were paved with bricks produced by the old brick factory when it was done as a paving element (Tuna and Erdoğan 2013).

#### **4. ART TOURISM**

People get to know themselves and others, as well as interact between societies. Tourism supports the development of social structure, cultural dialogue, and economic exchange.

Art and tourism have an indispensable quality in establishing communication between societies. Art tourism, which is rapidly developing as a new type of tourism within cultural tourism, has the power to stimulate and increase tourism demand. Many countries/regions/cities attract lots of tourists by creating a new image with their artists, artworks, and artistic activities. Destinations that offer their cultural and artistic resources to cultural and artistic tourists, who are better educated, have the desire to learn more, are conscious of environmental protection, spend more time in the places they visit and therefore have higher spending power, have a significant advantage (Swarbrooke, 1996; Meethan, 2001).

Art plays an active role in renewing the image of rural areas as well as cities, and art tourism has become increasingly widespread in recent years. Art tourism contributes to the continuity of local cultural identities in rural areas, the revitalization of villages, and the local economy. Thanks to the artistic activities organized in rural areas, the relationships between local people, artists, and art-loving tourists are redefined by art (Uğuz, 2015).



**Figure 15.** At Abetenim Arts Village, rammed earth and other modern earth-building techniques are promoted as a local and sustainable alternative to concrete blocks. These are practices run by the US-based non-profit Nka Foundation, which supplied local African youth with the opportunity to develop practical skills that will enable them to find employment in, the Republic of Ghana (Access 8).



**Figure 16.** Painting, photography, woodworking, handmade clothes, jewelry and jewelry making, furniture production, Carlsbad USA, (Accessed 9).



**Figure 17.** An hour away from the city of Tarapoto, at an altitude of 700 m, the San Roque De Cumbaza neighborhood in Lamas Province welcomes artists, Peru, Access,10)



**Figure 18.** Kaçkar Nature, human and art tourism, Çamlıhemşin / RİZE (Access 11)



**Figure 19.** Kaş eco art farm, (Access 11)



**Figure 20.** Sonsuz şükran village , Hüyük Konya (Access 12)



**Şekil 21:** Rhythm and Dance Camp, Edremit Balıkesir, (Access 13)



**Figure 22:** International Cappadocia Art Camp, Üçhisar Nevşehir, (Access 13)



**Figure 23.** International Cappadocia Art Camp, Üçhisar Nevşehir, (Access 13)

## **5. CONCLUSION**

Belief and art tourism have a significant place in cultural tourism, and form the basis of ecological cultural tourism. Ecological cultural tourism is one of the tourism sectors. This sector is developing on worldwide. Eco-museums are the implementers of eco-cultural tourism aiming at the sustainability of local identity, and cultural and social diversity, These can be defined as sustainable development projects

**Proceeding Book of ISESER 2023**

with an environmentally sensitive approach along with their contribution to the local and national economy. While with the classical museum understanding, the relationship of the person with the cultural heritage is limited, the person plays a role in the management of the tangible and intangible cultural heritage and the solution process of the existing problems with the understanding of the ecomuseum. For this reason, ecomuseums have the function of raising awareness of the local people about making sense of the past and interpreting the future, allowing all these values to be preserved and developed in their original places. The aim of ecomuseums that emerged as a result of globalization is to develop local economic development, to develop a sense of local belonging, and to protect local identity. Ecomuseums are places and areas that are very suitable for re-discovering, recognizing, respecting, and benefiting from indigenous history, local cultures, and religious and ecological diversity, which is the principle of environmental education. While eco-museums carry monumental, emotional, social, and cultural value, they ensure the sustainability of beliefs, traditions, and customs. Local handicrafts, gastronomic features, production style, etc. While ensuring its sustainability, it also allows people to observe and share values that are about to be forgotten. While all these values are protected and transferred to future generations, they also contribute to the local economy.

In conclusion; In line with the examples examined, a planning and implementation strategy for the eco-museum should be established as a 'Natural and cultural heritage protection-development and re-functioning strategy'. Especially, Turkey has many reserve areas that can be ecomuseum with its rich natural and cultural values that are very different from each other. The transfer and presentation of natural and cultural heritage assets to future generations in the form of the use of ecomuseum and their inclusion in urban life should be examined in the context of the 'ecomuseum planning and management strategy' produced in the process. While determining these strategies, a 'protectionist' approach should be adopted, which is based on the sustainability of the natural and cultural values of the region.

**REFERENCES**

- Akpınar Külekçi, E.,A., Bulut, Y., Sezen, I., 2020, Oltu ve Olur (Erzurum) İlçeleri Yayla Turizmi Potansiyelinin Coğrafi Bilgi Sistemiyle Belirlenmesi. Atatürk Üniversitesi Sosyal Bilimler Enstitüsü Dergisi, 24 (1), 291-302.
- Aşur, F., and Yazici, K. 2020, Observers Perceptions of Aesthetic Quality of High Rise Buildings in The Urban Landscape The Case Of Levent İstanbul. Fresenius Environmental Bulletin, 29, 11165–11174.
- Aydın, .1990, Açıklamalı Turizm Terimler Sözlüğü, s. 27, Aydın.
- Emekli, G. 2006, Coğrafya, Kültür ve Turizm: Kültürel Turizm”, Ege Coğrafya Dergisi, 15, s: 51-59.İzmir.
- Gülgün, B., Yazici, K., Dikmen, A. and Dursun, Ş. 2014a, Ecotourism importance of Sumela Monastery in Trabzon Turkey. Journal of Food, Agriculture Environment, 1140–1145.
- Gülgün, B., Güney, M. A., Aktaş, E., and Yazici, K. 2014b, Role of the Landscape Architecture in Interdisciplinary Planning of Sustainable Cities. Journal of Environmental Protection and Ecology, 15(4), 1877–1880.
- Gülgün, B., Yazici, K., Ankaya, F., & Balık, G. (2019). Olimpiyat Köyleri Ülkeye Katkıları Dünya dan ve Türkiye den Örnekler. Ulusal Çevre Bilimleri Araştırma Dergisi, 2(1), 1–10.
- Gülgün, B., Yazici, K., & Ankaya, F. (2017). Ecotourism in Turkey from Past to Present and the Scientific Awareness. Karabuk University Journal of Institute of Social Sciences, (3), 1–10.
- Koçoğlu, M., 2006, Bahçeşehir Üniversitesi Hükümet Ve Liderlik Okulu Yayını s. 144-169
- Meethan, K. 2001. Tourism in Global Society: Place, Culture, Consumption. Basingstoke: Palgrave.
- Pirli, A. and Yazici, K. 2022, Thematic Analysis of Universal Gardening Exhibitions Expo 1960 2019 Horticultural Exhibitions. Presented at the Mediterranean International Conference on Research in Applied Sciences, Antalya.
- ociovalișteanu, D. B. G. Niculescu., 2010, Sustainable Development Through Eco-Cultural Tourism, European Research Studies, Volume XIII, Issue (2), s: 150-154.
- Pressenda, P. and Sturani M. 2007, Open-Air Museums And Ecomuseums as Tools for Landscape Management: Some Italian Experience, European Landscapes and Lifestyles: The Mediterranean and Beyond, s: 2-16
- Soykan, F. 2000, “Turizm Coğrafyası ve Turizm Planlaması”, Ege Coğrafya Dergisi, 11, s: 39-55. İzmir.
- Sargın, S. 2006, “Yalvaç'ta İnanç Turizmi”, Fırat Ün. Sosyal Bilimler Dergisi: 16 (2), S: 1-18. Elazığ

**Proceeding Book of ISESER 2023**

- Sinha, G. N. 2009, Eco-Cultural Tourism As a Means for Sustainable Development. State Forest Research Institute, Itanagar, s:1-4.
- Swarbrooke, J. 1996, Culture, Tourism, Sustainability of Rural Areas in Europe. In: Robinson M., Evans, N., Callaghan, P., (1996), Managing Cultural Resources for Tourist: Tourism and Culture-Towards the 21st Century Conference Proceedings, University of Northumbria, Newcastle, UK, pp. 447-470.
- Tapur, T., 2009, Konya İlinde Kültür Ve İnanç Turizmi, Dr., S.Ü.Ahmet Keleşoğlu Eğitim Fakültesi Coğrafya. Konya
- Tuna, A., Erdoğan, E., 2013, Ekolojik Kültürel Turizm Aracı Eko Müzelerin Kültürel Peyzaj Açısından İrdelenmesi, Ormanlık Dergisi 9(2) (2013) 23-37.
- Uğuz, S., Ç., 2015, Sanat Turizmi Kapsamında Sanat Köyleri/ Sanat Akademileri/ Sanat Kampları Uygulamaları ve Kırsal Turizme Katkıları, Uluslararası Sosyal ve Ekonomik Bilimler Dergisi International Journal of Social and Economic Sciences 5 (2): 25-28, 2015 ISSN: 1307-1149, E-ISSN: 2146-0086, [www.nobel.gen.tr](http://www.nobel.gen.tr)
- Yazici, K., Gülgün, B., and Ankaya, F. 2017, Potential of Rural Tourism and Ecotourism and SWOT Analysis Case of Başkale Van Turkey and Its Surroundings. Karabuk University Journal of Institute of Social Sciences, (3), 131–144.
- Yazici, K., and Gülgün, B. 2019, The Visual Quality Effect of Historical Building Gardens on Urban Texture in The Sustainable Landscape. Fresenius Environmental Bulletin, 5(2), 3756–3767.
- Yazici, K. and Aşur, F. 2021, Assessment of Landscape Types and Aesthetic Qualities by Visual Preferences Tokat Turkey . The Journal of Environmental Protection and Ecology, 22(1), 340–349.
- Yazici, K., Gülgün, B., and Dursun, Ş. 2018, Sustainable Relationship Among Environment Landscaping and Ecotourism. Presented at the 8th International Conference of Ecosystems 2018 .
- Zengin M. ve Alkan H. 2018, Denizli Termal Sağlık Turizm Çalıştay Kitabı. Pamukkale Üniversitesi e-Yayımları No:3, e-ISBN: 978-975-6992-73-9, s:51, Pamukkale / Denizli

**Access Links:**

- Access 1: [www.wikipedia.com](http://www.wikipedia.com) Access date: 21/10/2021
- Access 2: [https://www.dunyadinleri.com/tr-TR/haberler/yahudi-haber/oku\\_israil-sukot-bayramini-kutluyor](https://www.dunyadinleri.com/tr-TR/haberler/yahudi-haber/oku_israil-sukot-bayramini-kutluyor) Access date: 21/10/2021
- Access 3: [https://www.salom.com.tr/arsiv/haber-94321-gizlenenin\\_aciga\\_cikisi\\_purim\\_.html](https://www.salom.com.tr/arsiv/haber-94321-gizlenenin_aciga_cikisi_purim_.html) Access date: 21/10/2021
- Access 4: <https://okuryazarim.com/konya-karatay-medresesi/> Access date: 20/10/2021
- Access 5: <https://konyabulteni.com/karatay-medresesi-cini-eserler-muzesi/> Access date: 20/10/2021
- Access 6: <https://eds.a.ebscohost.com/eds/pdfviewer/pdfviewer?vid=0&sid=917f4bd2-8b65-4582-a4df-ab8857673577%40sessionmgr4008> Access date: 21/10/2021
- Access 7: <https://www.lejsl.com/edition-montceau-les-mines/2020/04/05/creusot-montceau-l-ecomusee-s-invite-chez-vous> Access date: 24/10/2021
- Access 8: <https://www.fieldstudyoftheworld.com/abetenim-arts-village-and-the-rammed-earth-schools-of-ghana/> Access date: 25/10/2021
- Access 9: <https://www.loopnet.com/Listing/300-Carlsbad-Village-Dr-Carlsbad-CA/12426561/> Access date: 25/10/2021
- Access 10: <https://www.sachaqacentrodearte2.com/about-1> Access date: 25/10/2021
- Access 11: <http://kasartcamp.com/tr/> Access date: 25/10/2021
- Access 12: <http://www.sonsuzsukran.org/> Access date: 25/10/2021
- Access 13: <http://www.kapadokyasanat.com/> Access date: 25/10/2021



**Proceeding Book of ISESER 2023**

**O 9. AQUASCAPING AND WATERSCAPES AS AN UNDERWATER LANDSCAPE ART**

Melisa GÖNEN<sup>1\*</sup>, Damla PİRLİ<sup>2</sup>, Atakan PİRLİ<sup>3</sup>, Bahriye GÜLGÜN<sup>4</sup>, Nilgün YENİL<sup>5</sup>

<sup>1</sup>*Ege University, Graduate School of Natural and Applied Sciences, Department of Environmental Sciences, Izmir, Türkiye*

<sup>2</sup>*Ege University, Graduate School of Social Sciences, Department of Radio-Television and Cinema, Izmir, Türkiye*

<sup>3</sup>*Ege University, Graduate School of Natural and Applied Sciences, Department of Landscape Architecture, Izmir, Türkiye*

<sup>4</sup>*Ege University, Agriculture Faculty, Department of Landscape Architecture, Izmir, Türkiye*

<sup>5</sup>*Manisa Celal Bayar University, Faculty of Arts and Sciences, Department of Chemistry, Manisa, Türkiye*

E-mail: [melisagonen3@gmail.com](mailto:melisagonen3@gmail.com)

**ABSTRACT:** Forests, valleys, rivers, mountains are being destroyed by human activities and conventional nature landscapes are deteriorating. In the context of reinterpreting nature landscapes, aquascaping makes it possible to transport the longed-for nature landscapes between spaces. Aquascaping, which enables the introduction of aquatic plants and their placement in a composition outside their natural habitats, is an artistic activity that rises with the works of artists operating in different countries and develops under the name of the underwater design industry. The concept of aquascaping, evaluated within the scope of the study, aims to show that it is possible to make the underwater ecosystem sustainable in the indoor landscape. Within the scope of the study, the concept of aquascaping will be introduced as a concept that can be included in academic landscape education.

*Keywords: Aquatic Plants, Aquascaping, Aquatic Plant Art*

## **INTRODUCTION**

Today, in cities where construction is increasing, people are stuck in closed spaces and their access to natural landscape areas is restricted. The pollution caused by intensive construction has caused the emergence of factors such as stress. The diminishing presence of green spaces in cities has revealed the need for individuals to shape their own environment. The potential benefits of living in harmony with nature for urban people have been researched by those working on environmental psychology, and it has been widely accepted in many environmental literatures that the association with nature has positive effects on human psychology (Özgüner, 2004). The transfer of the natural landscape to the interior, by ensuring the integration of the exterior with the interior, has revealed a description of the "green nature" image that people long for. The emergence of this image made possible the spatial transfer of natural materials such as stone as well as various plants. Individuals who apply their aesthetic values while shaping the interior have developed hobbies where they can create replicas of various natural landscape views. Aquascaping is among these hobbies, allowing people to reflect their aesthetic sensibility indoors.

### **1. WHAT IS AQUASCAPING?**

The aesthetic value of a landscape is usually represented in the visual value of the landscape (Eroğlu and Başaran, 2017; Daniel and Boster, 1976). Visual landscape quality can also be defined as the relative aesthetic perfection of a landscape and can be measured by the taste of the observer (Kıroğlu, 2007). Allowing the representation of outdoor landscapes to be carried indoors, aquascaping makes it possible to use aquatic plants, which are important components of the aquatic ecosystem, with their aesthetic function as ornamental plants. In this context, the underwater landscape design art (perhaps related to the drop) has its roots in an old study. The aquarium principle, discovered by Robert Warington in 1850, was developed on the calculation that plants added to the water in a container could give enough oxygen to support animals if their numbers were not too large; this work has been accepted as the origin of the modern aquarium (URL 12). Aquascaping or underwater gardening, which aims to create a natural aquatic environment in the aquarium, is an aesthetic arrangement art in which materials such as rocks and stones are used together, if it is suitable for the chosen theme, as well as aquatic plants. In other

Proceeding Book of ISESER 2023

words, aquascaping, which creates the opportunity to experience gardening under water, also allows thematic gardens and landscapes to be exhibited indoors. Although Aquascaping is designed to create an underwater landscape created with artistic and aesthetic concerns, it requires technical maintenance. The maintenance of the tank in which plants and other materials are placed must be considered along with the technical aspects and growth requirements of aquatic plants. In the closed system of an aquarium tank, many factors need to be balanced to ensure an aquarium design is successful. These factors include filtration, keeping carbon dioxide at levels sufficient to support underwater photosynthesis, fertilization (may be chemistry), lighting, and algae control (James, 1986). Known as underwater landscape, aquascaping is evaluated by categorizing designs that enable different compositions to emerge. There are different water design styles that differ according to the type of aquatic plants used in the tank and their material preferences, each with specific characteristics.

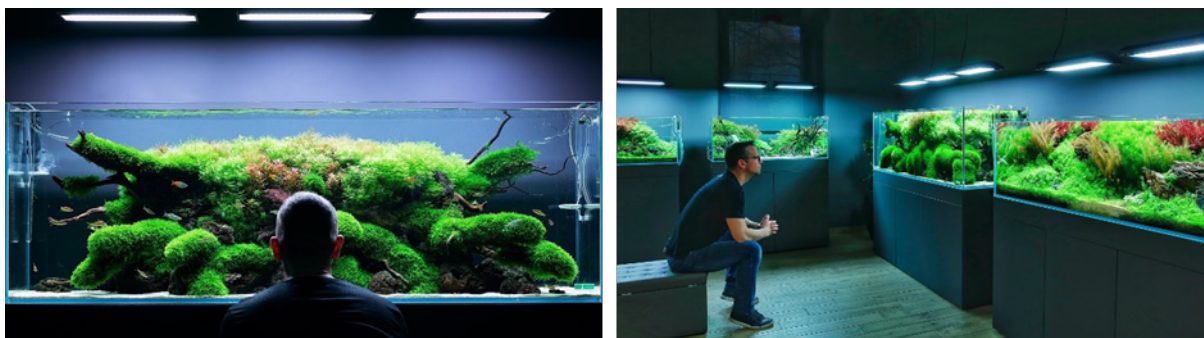

Figure 1. Aquascaping example (URL 12)

### 1.1. Aquatic Plants Used in Aquascaping Designs

All plants need water, which is the source of life. But some plants constantly live in water and have adapted to this life. Some plants, on the other hand, live in constantly wet soils along the waterfront (Gülgün et al., 2007). Aquatic plants, which are taken from their natural habitats and started to be used in underwater landscape designs, are placed in compositions where they can continue their development under artificial conditions. Aquatic plants, which help us create a space within the space and describe the scenes we are familiar with in nature, are also considered as design objects. The developing aquatic design industry has facilitated the introduction of aquatic plants, their circulation in the market and their delivery to aquarium designers. Thus, plants that are perhaps not known in their own habitat were introduced to the relevant people by being circulated in social media and made accessible.

Table 1. Aquascaping Designs and Plants Used



#### **Dutch aquarium example (Chun,2019).**

Popularized by the marketing of the first aquarium equipment in the Netherlands in the 1930s, this style of aquascape is entirely focused on growing and arranging aquatic plants (URL 2). The main focus in the Dutch style, which does not involve the use of any hard landscape materials such as driftwood, rock, or stone, is the height, color, and texture of a wide variety of aquatic plants. The basic placement technique in the tank is the terracing approach. The ability to apply this technique and create an aesthetically pleasing Dutch-style waterscape requires the aquarium designer to have a great deal of knowledge about different plants. Hygrophila, and red-leaved Alternanthera reineckii are used to provide texture and stepped structure, which is important in this style, and various Rotala species are used for accents. However, it is important that most of the aquarium floor is covered with plants. Some of the most used plant species in Dutch-style planted aquariums are

Saurus cernuus and Lobelia cardinalis, Hygrophila corymbos, Limnophila aquatica. In addition, species such as Alternanthera reineckii, Ammania, Rotala are preferred to create color accents and focal points. Java moss, on the other hand, is used to act as a surface cover to hide the materials placed in the design (URL 7).

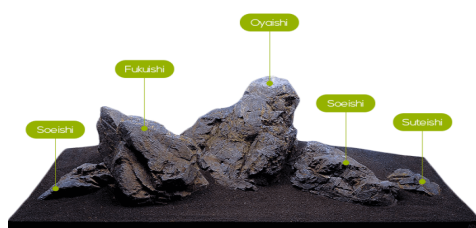

---

#### **Iwagumi style aquarium (Just,2012).**

It is based on the design of a rock arrangement (hardscape). Only one to three types of aquatic plants are used (URL 1). In the Iwagumi style, which is also called rock garden, the use of dwarf plants is common. All about calm and zen feeling, the Iwagumi style offers a kind of waterscape inspired by the Japanese gardening style. Typical installation for an Iwagumi waterscape involves the use of three main stones. The largest of the three stones to be used is called Buddha; Two small stones called attention stones are added to complete the design (URL 1). Regardless of their number, each stone in the Iwagumi design has a name and a specific role it plays. Symmetry and balance are essential in the placement of stones. It is important to use stones of the same color and texture to create a sense of unity and harmony in the tank. Plants in an Iwagumi-style aquarium are limited, due to the demand to avoid plants blocking the stones and to focus on a more spacious and minimalistic aquarium. The most popular plants are small carpet plants such as Hemianthus callitrichoides Cuba, Eleocharis acicularis and parvula, Glossostigma elatinoides, Mikranthemum umbrosum Monte Carlo, Utricularia graminifolia.



---

#### **Wild West, designed by Stjepan Erdeljić in a nature aquarium style (URL 4).**

The nature aquarium style aims to create a landscape that resembles a landscape or image from the natural world. The most common nature aquarium waterscapes are designs that depict underwater versions of rainforests, mountains, slopes, beaches, or valleys. In the search for balance in the aquarium, both hardscape materials and plants play an important role to be selected according to the landscape to be depicted. Nature aquarium can be considered as the richest category in terms of landscape options that can be designed. In this category, where themes such as island, valley, slope, and mountain range can be designed, the use of plants also varies according to the selected landscape. Small-leaved plants such as Glossostigma elatinoides, Eleocharis acicularis, Eleocharis parvula, Echinodorus tenellus, Hemianthus callitrichoides, Riccia fluitans, and small water ferns, as well as Staurogyne repens and Java moss (Versicularia dubyana or Taxiphyllum).

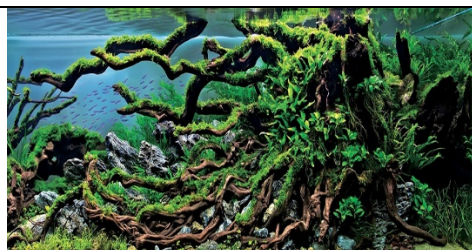

---

#### **Verve, designed in the style of Ryoboku. Chow Wai Sun. Hong Kong. 2011**

This waterscape style is based on using wood as the main hardscape material. The word Ryoboku, which can be translated as "driftwood" in English, represents aquariums built with wood (URL 5). There are many types of trees that can be used in this style, including driftwood roots. Stones

of various structures and aquatic plants are also used in this design style, whose focus is on tree roots and woods. In the ryoboku style, *Taxiphyllum barbieri* or Java moss (Fig. 10) is preferred to cover woods and tree roots. Among the other aquatic plant species mainly used in this style are *Taxiphyllum* sp. aka peacock moss and *Leptodictyum riparium* or fibrous moss are examples (URL 8).



#### Forest or Jungle Style

Jungle-style waterscapes often feature hard materials with little or no visibility. Due to the density of plants, the aquarium has limited open space. Plants with thicker, coarser leaf shapes, such as *Echinodorus bleheri*; used to provide a wild, untamed look. Unlike nature style, forest style does not create clean lines or use fine textures (URL 6). The presence of dense plants reduces the light transmittance in the aquarium and provides a shaded environment. There is intensive use of plants in forest style. A forest canopy effect can be achieved by using combinations of darker substrates, tall plants that grow to the surface, and floating plants that block light and provide a variegated lighting effect (URL 6). Among the plants used in forest style waterscapes, there are species such as *Microsorium pteropus* as well as *Bolbitis heudelotii*, *Vallisneria americana*, *Crinum*, *Aponogeton*, *Echinodorus*, *Sagittaria subulata*, *Hygrophila pinnatifida*, *Anubias*.

### 1.2. Aquascaping as an Art and the Emerging Design Industry

Aquascaping term is often explained as underwater landscape gardening (Akshitha and Girwani, 2020). Underwater landscape gardening is considered as a form of art (Martin, 2013). It is often referred to as living art. Aquascaping is different from any other art form because it is so rich and diverse. Composition is the art of arranging all of the aquarium's interior components such as wood, rocks, and plants, as well as the use of open space, light, and shade (Farmer, 2020). Colors and textures provide visual interest to an aquascape. Consider the colors of the hardscape and how it contrasts with the plants. Arranging the landscape elements in the aquarium according to the golden ratio is also considered extremely important.

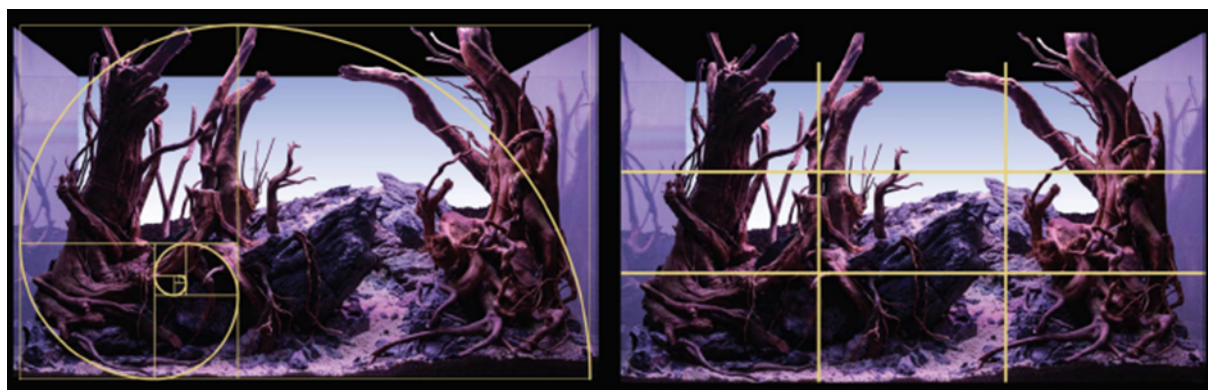

Figure 2. Golden Ratio of Aquascaping (Farmer,2020)

As with all art forms, aquascaping is subjective and in some respects. There is no style that's better than another it's a matter of taste and sensitivity. So, aquascaping brings science and art together. In this context, it has revealed underwater landscape designers who are dedicated to revealing living works of art and therefore these works. The developing underwater design industry has made it possible to display plants indoors by using them in various compositions. It ensures that the lost nature landscapes are

**Proceeding Book of ISESER 2023**

depicted and watched indoors and made sustainable. In this context, hundreds of people who unite around aquascaping participate in international competitions and share their designs. IAPLC (International Aquatic Plant Layout Competition) is an international planted aquarium competition in which participants compete with each other to create original "waterscapes" in the aquarium. Participants send a photograph of the water scenes they took during the year they are in, and the works sent from all over the world are evaluated by the jury members who are experts in the sector. The interest in the competition both promotes aquatic plants and confronts individuals with the destruction of nature through the designed landscapes. The total number of applications and the number of participating countries to the competition, which started in 2001 with 19 participating countries and a total of 557 works, is increasing every year. Currently, with more than 60 participating countries and a total number of applications close to 2,000, IAPLC is held as a worldwide competition (URL 10).



**Figure 3.** Forest Scent, Pavel Bautin. Russia. 2010 IAPLC Grand Prize Winner (URL 13)

There are also artists who play a pioneering role in representing aquascaping designs as exhibition objects or works of art. Takashi Amano, who was born in Niigata, Japan in 1954, is known as a Japanese landscape and landscape photographer (URL 11). Takashi Amano, the founder of Nature Aquarium and CEO of Aqua Design Amano Co., Ltd., is known as a name that seeks the source of designing waterscapes in nature aquariums in nature itself. The artist's observation site and the source of his designs are rainforests, known for their large rivers and aquatic plants. Visiting the tropical rainforests of the Amazon, Borneo, and West Africa and the pristine forests of Japan since 1975, Amano works with his large-format cameras on a series of photographs focusing on "pristine nature" and reinterprets the landscapes he captures in his photographs. Although only Takashi Amano is mentioned within the scope of this study, as he is considered a pioneer in the field, there are different artists who contribute to the development of the underwater design industry and continue their activities in different countries.

## **2. O<sub>2</sub> SOURCE FOR THE AQUARIUM**

### **2.1. Aquatic plants and the effects of CO<sub>2</sub>, O<sub>2</sub> and sunlight on the photosynthesis process**

Photosynthesis is a chemical process that occurs in almost all plants, including aquatic plants. The ability of plants to perform photosynthesis depends on three basic nutrients such as carbon dioxide (CO<sub>2</sub>), water (H<sub>2</sub>O) and sunlight. Oxygen (O<sub>2</sub>), a by-product of the photosynthesis process, is one of the vital resources of life for humans and animals. Since, depending on the presence of algae, bacteria and plants that perform photosynthesis on the earth's surface, the air that people and living creatures breathe can be provided. Continuity of photosynthetic process is required to return and renew the oxygen needed in the Earth's biosphere. The first data on the photosynthetic process appear in primitive forms of algae and bacteria and date back many years (İşler, 2023).

The sun supports the abundance of oxygen in the water. Because algae and all aquatic plants in the water continue to perform photosynthesis owing to the sun's nourishing rays and provide plenty of oxygen to the water. In cloudy weather, this situation is reversed and the amount of oxygen in the water decreases significantly compared to sunny weather. Thus, when the sun, the basic nutrient of photosynthesis, is not available, photosynthetic plants, like other living things, evolve to consume oxygen in the air. In summary, whether it is an open system or a closed system such as an aquarium, all plants, including algae and aquatic plants, must benefit from sunlight at the maximum level in order to

Proceeding Book of ISESER 2023

provide the oxygen needs of all living things in the universe. As a result, the amount of oxygen in the universe remains balanced. In this context, appropriate lighting systems with wavelengths close to daylight should be used for aquatic plants used in a closed system such as an aquarium (Bakırcı, 2019).

In lighting systems, some important concepts can be listed as follows; for the light source Watt value (defined as the power drawn by the system from the power line), Lumen value (roughly expressed as the brightness of the light), Kelvin value (this value is 5800 Kelvin for the sun. While increasing of this value the color shifts to blue and its decreasing the color shifts to red. The value considered white is in the range of 6000-6500 Kelvin.), Photosynthetically Active Radiation (PAR) value (it represents the wavelength of light used by plants for the ideal photosynthesis process and corresponds to a wavelength of 400-700 nm), Photosynthetic Photon Flux (PPF) and Photosynthetic Photon Flux Density (PPFD) values (PPF expresses the flux of all photons released from the source in the PAR value region, while PPFD measures the value of PPF per unit. In briefly, PPF measures the amount of photosynthetic light coming out of the source, and PPFD measures the amount of photosynthetic light per area on the plant.), Daily Light Integral value (DIL) (it is the sum of the photosynthetic light per unit area in a 24-hour period and is a measure of how much photosynthetic light the plant receives.), Yield Photon Flux (YPF) value (this value is obtained by calculating the absorption coefficient at each wavelength and the values in the absorption spectrum, taking into account the plant's response to photosynthetic radiation at different wavelengths.). It should be noted that in lighting systems, indicators such as watts and lumens are not sufficient to understand the performance of the light, but values such as PAR, PPF and YPF have scientific meaning. In order to increase the PAR quality of the light and ensure homogeneous distribution of light in the system (light diffusion), a semi-permeable layer (white color) is placed in front of the light source to provide soft light and homogeneous illumination (Çağlayan, 2013).

The graph below shows the wavelengths corresponding to the absorption amount (absorbance) of some photosynthetic pigments. This graph expresses the percentage of absorption of 1 unit of light sent to the plant by the photosynthetic pigment and that plants respond differently under different lights due to pigment differences in their structures. As it is shown in the graph Chlorophyll A and chlorophyll B absorb blue light more than other regions, while phycoerythrin absorbs green light and allophycocyanin absorbs red light more than other regions (Kayalı, 2022).

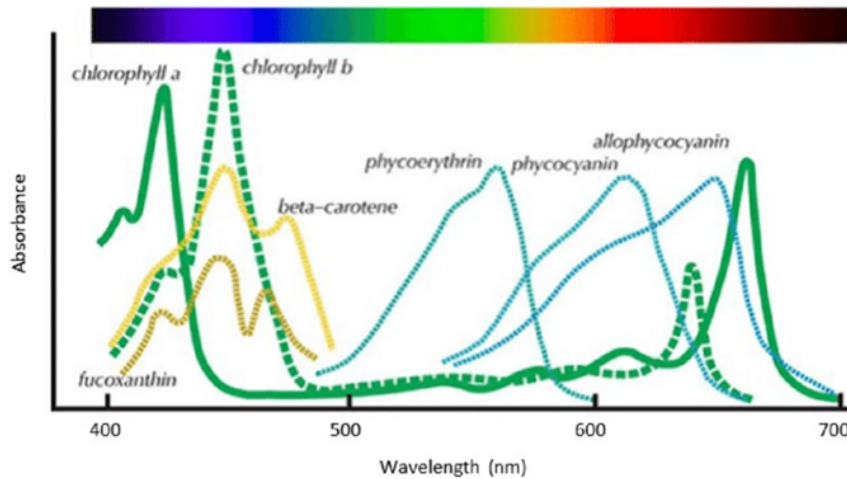

**Graph 1.** Wavelengths corresponding to the absorption amount (absorbance) of some photosynthetic pigments (Kayalı, 2022).

On the other hand, growing a plant using only blue-light or only red-light sources may create differences in the morphological structure of that plant. In addition, it should not be forgotten that used different light colors may have different morphological effects on different plants and that the higher absorption of any color is not meaningful in terms of plant photosynthesis (Dalkılıç, 2018).

The decrease in the amount of dissolved oxygen in surface waters disrupts the water quality of life and creates cultural eutrophication, which supports the formation of odors and bacteria and causes the death of fish. Therefore, necessary precautions must be taken to prevent algae and aquatic plants from deteriorating the quality of the water in their environment. Namely, since the basic nutrients of

### **Proceeding Book of ISESER 2023**

algae and aquatic plants are CO<sub>2</sub>, nitrogen (N<sub>2</sub>) and phosphorus (P), unbalanced and excessive use of these nutrients causes uncontrolled proliferation of algae and aquatic plants, which are fatal to living things. Similarly, if N/P and CO<sub>2</sub>/O<sub>2</sub> ratios are not kept balanced in aquarium systems, water quality will deteriorate due to uncontrolled plant growth and the resulting proliferation of microorganisms and bacteria in the aquarium. Therefore, eutrophication is inevitable in a closed system, too. Appropriate amounts of N and P fertilization should be made for aquatic plants used in the aquarium system, N/P ratios should be adjusted, and photosynthesis should be provided for the plant with enough daylight. In this way, the amount of dissolved oxygen in the water is increased and the quality of life for fish and living things is preserved. As a result, in aquarium systems, the nutrients amount of aquatic plants should be controlled, photosynthesis should be supported by making adequate use of quality daylight, and the amounts of CO<sub>2</sub> and O<sub>2</sub> in the system should be kept in balance. Accordingly, it is important to use appropriate lighting systems with wavelengths close to daylight in aquariums located in regions that receive insufficient daylight (Bütünoğlu, 2018).

The color of light is determined by the wavelength of the light. Light sources with a wide range from 380 nm to 840 nm are used in plant cultivation. These wavelength ranges of growth periods and their effects on plant development can be listed as follows (Bartucca, et al., 2020):

-It is the ultraviolet lights corresponding to the range of 380 nm-390 nm that guide the flowering of plants.

-Violet blue colored lights corresponding to the range of 400-410 nm support the green leaf development of the plant.

-Blue light in the range of 440-460 nm promotes root growth and green leaf growth.

-Yellow light corresponding to the range of 585-595 nm improves the taste by increasing the nutritional content and trace elements of the plant.

-Red light corresponding to the range of 660-670 nm supports the photosynthesis and photoperiod of the plant.

-Dark red light, corresponding to the range of 730-840 nm, supports the growth and flowering performance of the plant and therefore the productivity of the plant.

Apparently, many different colored lights are used by plant breeders to change the growth rate of the plant, the taste, color of the fruit and leaf, and many other characteristics. It is obvious that plants use this energy from red and blue light sources to grow by absorbing these lights rather than reflecting them. Red light is mainly responsible for the plant's flowering and fruit production. In addition, red light is needed for seed germination, root growth and bulb development of the plant. For this reason, red light in the wavelength range of 600-700 nm is used to support the development of the plant and improve the taste of the fruit. Blue light supports the production of chlorophyll, the most active pigment that supplies photosynthesis in plants. Therefore, the plants that receive plenty of blue light in the 400-500 nm wavelength will have strong, durable and healthy stems and leaves.

Outdoor plants can receive adequate amounts of both red and blue light under natural light. In interior spaces, deficiencies may occur in certain parts of the color spectrum. If the stem of the plant and the parts connecting the leaves to the stem are too long and the leaves lose their green color, it means that it is not receiving enough blue light. If the plant does not bloom when the time comes, it probably lacks red light. While different lamps can be used for red and blue light sources, special light sources can also be used as combined light sources in mixed red and blue light.

In summary, when the right light source is used, it is possible to grow many types of vegetables and fruits, regardless of the season, even on the coldest winter day. In this context, it is possible to accurately adjust the amount of light in different colors, as well as to ensure the adequate and vitality-supporting development of the plants in the aquarium environment and the oxygen balance in the water. Using the right light sources, even in aquariums in dimly lit environments, will support both the quality growth of the plants in the aquarium and the continuation of living life. As a result, balancing the amount of oxygen in the water and using the right light source is of vital importance for both the aquarium plants and the creatures living in that system, so the balance of all parameters in the aquarium system must be maintained in order to ensure the quality of life of every creature.

### **3. CONCLUSION AND SUGGESTIONS**

Art that paves the way for raising awareness about ecosystem destruction holds the potential to highlight the importance of biodiversity, preserve water ecosystem health, and create a sensitivity to

**Proceeding Book of ISESER 2023**

nature. Aquascaping, aimed at reinterpreting natural landscapes and providing a new perspective on landscape design, has also been considered as an art field to be taken into account in this study.

Aquascaping has the potential to artistically preserve areas facing the threat of destruction and extinction in nature, ensuring their transmission to future generations. Through its designs inspired by nature, aquascaping will enable us to confront and engage with the lost natural world by serving as a form of memory.

Designs that mimic nature can also be regarded as a critique of ecological destruction in the future. Depictions that evolve between today and the future will serve as a means to convey ecosystem damages. Aquascaping designs integrated into spaces will artistically highlight the contrast between the depicted and existing natural landscapes.

Aquascaping landscape designs not only make it possible to observe nature indoors but also play a role in introducing aquatic plants. This is significant in terms of the biological diversity that is currently at risk.

In this context, aquascaping, which makes underwater life visible and integrates different concepts with the aquatic ecosystem, can be considered beyond a hobby. Furthermore, it is believed that social activities such as underwater design competitions included in the study could be beneficial for understanding nature and gaining ecological awareness.

As a result of the literature review conducted during this study, which is an evaluation of aquascaping, which is thought to contribute to the promotion of aquatic plant existence in Turkey and raising awareness about the aquatic ecosystem, it has been determined that there is a serious resource deficit in our country. In this context, it is thought that it would be beneficial to include aquascaping studies in landscape education in order to introduce the endemic aquatic plant existence determined by academic studies in our country.

**REFERENCES**

- Akshitha, S. and Girwani A. 2020. Aquascaping: An Incredible Art Under Water. *Vigyan Varta* 1(8): 59-62.
- Bakırcı, Ç. M. 2019. Fotosentez ve Oksijen: Dünya'nın Oksijen Kaynakları Neler? Ağaçlar ve Ormanlar, Oksijen İçin Ne Kadar Önemli? <https://evrimagaci.org/fotosentez-ve-oksijen-dunyanin-oksijen-kaynaklari-neler-agaclar-ve-ormanlar-oksijen-icin-ne-kadar-onemli-8057> (Erişim Tarihi: 11.08.2023)
- Bartucca ML, Guiducci M, Falcinelli B, Del Buono D, Benincasa P. 2020. Blue:Red LED Light Proportion Affects Vegetative Parameters, Pigment Content, and Oxidative Status of Einkorn (*Triticum monococcum* L. ssp. *monococcum*) Wheatgrass. *J Agric Food Chem.* 2020 Aug 19;68(33):8757-8763. doi: 10.1021/acs.jafc.0c03851.
- Bütünoğlu, A. 2018. Su Kaynaklarında Yüzer Sulak Alan Ve Sucul Bitkiler İle Nutrient Gideriminin Değerlendirilmesi. Uzmanlık Tezi. TC. Tarım ve Orman Bakanlığı. Ankara
- Çağlayan, N. 2013. Seralar İçin Led Lambalı Aydınlatma Otomasyon Sisteminin Tasarlanmasına Ve Uygulanmasına Yönelik Bir Çalışma. Akdeniz Üniversitesi Fen Bilimleri Enstitüsü Tarım Makinaları Anabilim Dalı. Doktora Tezi.
- Conklin E. 1978. Interior Landscape Contractors Montvale, N.J.
- Dalkılıç. Z. 2018. Bitkilerde Fitokrom Işık Algılayıcıları. *ADÜ ZİRAAT DERG*, 2018;15(1):107-114 — doi: 10.25308/aduziraat.329081
- Eroğlu, E. & Başaran, N. (2017). İç Mekan Dikey Bahçe Bitki Kompozisyonlarının Görsel Peyzaj Kalitesinin Değerlendirilmesi . *Düzce Üniversitesi Orman Fakültesi Ormancılık Dergisi* , 13 (2) , 32-49 .
- Farmer, G. 2020. Aquascaping Aquascaping: A Step-by-Step Guide to Planting, Styling, and Maintaining Beautiful Aquariums. Skyhorse Publishing, New York.
- Gülgün, B. , Atıl, A. G. , Sayman, M. & Yörük, İ. (2007). Peyzaj Mimarlığı Çalışmalarında Kullanılan Bazı Önemli Akuatik Bitkiler ve Kullanım İlkeleri . *Ege Üniversitesi Ziraat Fakültesi Dergisi* , 44 (1) , 177-188.
- İşler, N. 2023. Bitkilerde Fotosentez Sistemleri. MKU Tarla Bitkileri Bölümü Ders Notları.
- James, B. (1986), *A Fishkeeper's Guide to Aquarium Plants* , Londra: Tetra Press/Salamander Books.



**Proceeding Book of ISESER 2023**

- Kayalı, Ö. 2022. Bitkili Akvaryum Aydınlatması Nasıl Yapılır? (Kapsamlı Rehber). <https://evrimagaci.org/bitkili-akvaryum-aydinlatmasi-nasil-yapilir-kapsamli-rehber-12995> (Erişim Tarihi: 20.08.2023)
- Kıroğlu E. 2007, Erzurum Kenti ve Yakın Çevresindeki Bazı Rekreasyon Alanlarının Görsel Peyzaj Kalitesi Yönünden Değerlendirilmesi, Atatürk Üniversitesi Fen Bil. Ens. Yüksek Lisans Tezi, s 28.
- Marin, M. 2013. *aquascaping: Aquarium Landscaping Like a Pro Aquarist's Guide to Planted Tank Aesthetics and Design*. Ubiquitous Publishing, New York.
- Özgüner, H. (2004). DOĞAL PEYZAJIN İNSANLARIN PSİKOLOJİK VE FİZİKSEL SAĞLIĞI ÜZERİNE ETKİLERİ . *Turkish Journal of Forestry* , 5 (2) , 97-107 .
- URL 1: <https://aquascapinglove.com/learn-aquascaping/what-is-aquascaping/> (Erişim Tarihi:20.06.2023)
- URL 2: <https://aquascapinglove.com/basics/introduction-iwagumi-layout/>(Erişim Tarihi:20.06.2023)
- URL 3: <https://www.thisiscolossal.com/2014/01/the-incredible-underwater-art-of-aquascaping/>(Erişim Tarihi:20.06.2023)
- URL 4: <http://www.aquascapinglab.com/en/2017/07/09/aquascaping-e-tecniche-di-allestimento-iwagumi-ryoboku-driftwood-biotopo/>(Erişim Tarihi:20.06.2023)
- URL 5: <https://iaplc.com/gallery/en/>(Erişim Tarihi:21.06.2023)
- URL 6: [https://en.wikipedia.org/wiki/Aquascaping#cite\\_note-4](https://en.wikipedia.org/wiki/Aquascaping#cite_note-4)(Erişim Tarihi:20.06.2023)
- URL 7: <https://www.clanaquascaping.com/aquascaping-nedir/>(Erişim Tarihi:20.06.2023)
- URL 8: <https://aquascapinglove.com/basics/guide-keeping-growing-aquatic-moss/>(Erişim Tarihi:20.06.2023)
- URL 9: <https://iaplc.com/e/about/>(Erişim Tarihi:20.06.2023)
- URL 10: <http://www.amanotakashi.net/>(Erişim Tarihi:21.06.2023)
- URL 11: <https://www.peyzax.com/aquascaping-su-alti-peyzaj-sanati/>(Erişim Tarihi:20.06.2023)
- URL 12: <https://i.ytimg.com/vi/hWT11OITfcU/maxresdefault.jpg>(Erişim Tarihi:20.06.2023)
- URL 13: <https://www.thisiscolossal.com/2014/01/the-incredible-underwater-art-of-aquascaping/>(Erişim Tarihi:20.06.2023)
- URL 14: <https://aquascapinglove.com/learn-aquascaping/what-is-aquascaping/>(Erişim Tarihi:20.06.2023)
- URL 15: [https://www.akvaryum.com/Forum/genel\\_iwagumi\\_rehberi\\_k489024.asp](https://www.akvaryum.com/Forum/genel_iwagumi_rehberi_k489024.asp)(Erişim Tarihi:20.06.2023)

**O 10. ESKAPE PATHOGENS IN ECOSYSTEMS: QUANTITATIVE MICROBIAL RISK ASSESSMENT**

Lyudmyla Symochko<sup>1,2,3\*</sup>, Olena Demyanyuk<sup>3</sup>, Vitaliy Symochko<sup>1</sup>

<sup>1</sup>*Uzhhorod National University, Uzhhorod, Ukraine.*

<sup>2</sup>*University of Coimbra, Coimbra, Portugal.*

<sup>3</sup>*Institute of Agroecology and Environmental Management, Kyiv, Ukraine.*

E-mail: [lyudmilassem@gmail.com](mailto:lyudmilassem@gmail.com)

**ABSTRACT:** Anthropogenic activities play a significant role in shaping the environmental resistome. These findings have led to the development of the "One-Health" approach, which seeks to improve understanding of AMR in the human, animal, and environment. ESKAPE is a group of six bacterial pathogens that are highly virulent and resistant to antibiotics, including *Enterococcus faecium*, *Staphylococcus aureus*, *Klebsiella pneumoniae*, *Acinetobacter baumannii*, *Pseudomonas aeruginosa*, and *Enterobacter* spp. ESKAPE pathogens are differentiated from other pathogens due to their increased resistance to commonly used antibiotics such as penicillin, vancomycin, carbapenems and more. From 2016 to 2021, various types of ecosystems were monitored for the presence of ESKAPE pathogens, including a water ecosystem (river Uzh) and agricultural ecosystems. The results showed an increasing number of ESKAPE pathogens in these environments. Specifically, the number of ESKAPE pathogens in the river Uzh increased by 1.65 times (from n=35 to n=58) and in agroecosystems by 2.21 times (from n=73 to n=162). The water ecosystem was found to contain *Klebsiella pneumoniae*, *Enterococcus faecalis*, and *Enterococcus faecium* with high level of antibiotic resistance, while soil samples from the agricultural ecosystems contained *Pseudomonas aeruginosa*, *Enterococcus faecium*, *Enterococcus faecalis*, *Staphylococcus aureus*, and *Acinetobacter baumannii*. These findings highlight the urgent need for better monitoring and management of ESKAPE pathogens in various ecosystems to prevent further spread and development of antibiotic resistance.

*Keywords: Resistome, Environment, ESKAPE Pathogens*

**Proceeding Book of ISESER 2023**

**O 11. GEOSMIN AND 2-METHYLISOBORNEOL REMOVAL FROM AKSARAY'S TAP WATER BY POWDERED ACTIVATED CARBON**

Jamila MOHAMAD<sup>1</sup>, Niyazi NAGHIYEV<sup>1</sup>, Emine BAŞTÜRK<sup>2</sup>, Mustafa IŞIK<sup>1</sup>

<sup>1</sup>*Aksaray University, Engineering Faculty, Department of Environmental Engineering, Aksaray, Turkey.*

<sup>2</sup>*Department of Environmental Protection and Technologies, Technical Sciences Vocational School, Aksaray University, Aksaray, Turkey.*

E-mail: *gmyla.mohamat@gmail.com, naghiyevnn@gmail.com, eminebasturk@hotmail.com, mustafaisik@aksaray.edu.tr*

**ABSTRACT:** G Geosmin(GSM) and 2-Methylisoborneol (MIB) and are responsible for musty-earthy taste and odor in drinking-water, a severe problem throughout the world. Due to the increasing perception in recent years, it has become necessary to remove these compounds from water. Compared to other methods, adsorption is known to be an accepted treatment method for GSM and 2-methylisoborneol removal. In this study, the removal of these compounds by adsorption with a commercial PAC carbon was investigated in Aksaray's tap water. The adsorption process was studied with seven isotherm models (Langmuir, Freundlich, Temkin, Dubinin – Radushkevich, Harkin-Jura, Halsey, and Redlich-Peterson) and four kinetic models (pseudo first-order, pseudo second-order, Elovich, and intra-particle). The results showed that the adsorption isotherm and kinetic model of GSM and MIB could be best described by the Freundlich isotherm and pseudo second-order kinetic model for both compounds. As a result of the study, it was found that due to the high organic matter found in Aksaray tap water, GSM and MIB concentrations could not be removed below the odor threshold value with PAC application alone.

*Keywords: Adsorption, Isotherm, Kinetic, Taste and Odor, PAC*

## **O 12. OVERVIEW OF THE NEGATIVE EFFECTS OF CLIMATE CHANGE**

Fatma KUNT<sup>1</sup>, Busenur KÖPÜKLÜ<sup>1\*</sup>, Flora MERKO<sup>2</sup>

<sup>1</sup>*Necmettin Erbakan University, Environmental Engineering Department, Engineering Faculty,  
Konya, Türkiye.*

<sup>2</sup>*Aleksander Moisiu University, Department of Economics, Durres, Albania.*

E-mail: [bnur.kpkl@gmail.com](mailto:bnur.kpkl@gmail.com)

**ABSTRACT:** Climate change has negatively affected the entire ecosystem from past to present. The increasing population, especially with the development of industry, has led to excessive consumption and increased greenhouse gas emissions. Today, climate change is seen as a serious environmental problem and important studies and research are carried out on this subject. In order to find a solution to this problem that affects the whole world, scientists come together at conferences on the subject. Increasing rainfall, floods, landslides, drought and air pollution due to increasing greenhouse gases on a global scale pose a fatal threat to agricultural areas, food security and clean water resources. Many studies were described in this review article. Information was given about marine protected areas established for marine life affected by climate change. In particular, the negative effects of climate change on human health and psychology in Turkey and the world were mentioned.

*Keywords: Climate Change, Ecosystem, Effects, Health, Human, Psychology*

### **1. INTRODUCTION**

The atmosphere required for the existence of all forms of life on Earth is essentially a combination of different gases. Molecules of 78.08% of nitrogen and 20.95% of oxygen in the atmosphere constitute 99% of the volume of clean and dry air. The remaining approximately 1% of dry air consists of argon (0.93%), an inert gas, and trace gases whose quantities are very small. Although its accumulation in the atmosphere is small, carbon dioxide (CO<sub>2</sub>), an important greenhouse gas, is present at a rate of 0.0377%. The most important natural greenhouse gases are water vapor (H<sub>2</sub>O) and CO<sub>2</sub>, methane (CH<sub>4</sub>), nitrogen monoxide (N<sub>2</sub>O) and ozone (O<sub>3</sub>) (Türkeş, 2008). Weather is all the atmospheric phenomena that can be experienced and observed anywhere on earth and at any time. Climate is defined as the combination of the average characteristics of all weather conditions that can be experienced and observed anywhere and at any time on earth, their temporal distributions of their frequency of occurrence, observed extreme (extreme) values, violent events and all types of variability. (Türkeş, 2001). Climate can affect human activities, well-being and health in different ways. From past to present, humanity has attempted to organize its shelters, food and energy production in order to create a lifestyle generally compatible with climate and environmental conditions, and to adapt itself to this resource. Climate change can be defined as statistically significant changes in the average state of the climate or its variability over many years. Climate change can be defined as statistically significant changes in the average state of the climate or its variability over many years. Climate change can occur due to natural internal processes and external forcing factors, as well as continuous anthropogenic (human-induced) changes in the composition of the atmosphere or land use. Changes in climate occurred between glaciers and ice ages, in the form of major changes in average temperatures in various parts of the world, and also included changes in precipitation. Throughout the Earth's very long geological history of 4.6 billion years, there have been many changes in the climate system by natural factors and processes at all time scales from millions of years to decades. Climate changes in geological periods have not only changed the world geography, especially through glacial movements and changes in sea level, but also created permanent changes in ecological systems. However, since the mid-19th century, it has been realized for the first time that human activities also affect the climate. Therefore, today, climate change can be defined by taking into account human activities that increase greenhouse gas accumulation. For instance, in the United Nations Framework Convention on Climate Change (UN FCCC), climate change is defined as "A change in climate resulting, directly or indirectly, from human activities that disrupt the composition of the global atmosphere, in addition to the natural climate change observed for many years." a comparable period." (Türkeş, 2008). Climate temperatures have an impact on all living events. In addition, climate change

## **Proceeding Book of ISESER 2023**

may have different effects on agriculture, industry, and all economic conditions. With the explosion of fossil fuels in the Industrial Revolution, many emissions were released into the atmosphere. In addition, human causes such as the release or destruction of natural vegetation, especially forests, land use change, and urbanization, have increased greenhouse conditions by triggering heat retention in the atmosphere (Karadeniz et al., 2019). The Report on the Physical Foundations of Climate Change, which is the first of the Sixth Assessment Report (AR6) of the Intergovernmental Panel on Climate Change (IPCC), which brings together the most comprehensive and up-to-date scientific studies on climate change; has been stated that risks related to climate change will be earlier and more dangerous than expected (Birpınar, 2022). The effects of climate change started in the 17th century (Hulme, 2009), and human-induced factors such as industry development are shown as the most important reason (Akbulut et al., 2021). Today, climate change is seen as a serious environmental problem, and significant studies are carried out on this issue. While climate change is not taken seriously in some societies today, and the reality and effects of this issue are not believed, it is taken very seriously in some communities (Hulme, 2009). Since the end of the 19th century, it has been understood by French Joseph Fourier, Swedish Chemist Svante August Arrhenius, and some scientists that the carbon density in the atmosphere has increased as a result of fossil fuel use and that nature cannot cope with this ecologically, and it has been recommended to reduce emissions quickly. However, the world, especially the West, remained silent to these warnings, and instead of reducing the use, they increased it further, increasing the carbon emission value, today which was around 5-6 billion tons annually at that time, to 40 billion tons (Birpınar, 2022). Tackling climate change and its impacts requires well-informed and concerted action by a variety of actors from different sectors of society. Additionally, climate change response strategies need to be placed within a multi-purpose context of environmental, social, technical and economic developments whose future is inherently uncertain. Climate change scenarios have been a central tool in climate change research for decades. These scenarios describe plausible, consistent and internally consistent pathways for the future of climate change. Since we cannot know the future with certainty, the uncertainty of climate change scenarios should be structured with scientific rigor. "What could happen?" The question should be investigated and "What should happen?" The question needs to be planned. Scenarios therefore serve in two ways: first, different groups of actors (politics, business, science, society) can coordinate their thoughts from different perspectives, develop a common understanding of the situation and co-produce new knowledge. Secondly, climate change scenarios can support strategic planning by revealing different paths from a multi-purpose perspective and under uncertainty. Various types of scenarios should emerge through coordinated efforts to consistently address different aspects of climate change (Auer et al., 2021).

## **2. RESULTS AND DISCUSSIONS**

Due to increasing greenhouse gases on a global scale, the first World Climate Conferences (WMO, 1979) were held in 1979. Decisions were taken to restrict the use of chemicals that cause problems, especially due to the depletion of the ozone layer over Antarctica, and the Vienna Convention for the Protection of the Ozone Layer (UN, 1985) was signed in 1985. The mentioned agreement was the first globally successful agreement in the field of environment and climate (Birpınar, 2022). As in the Third Assessment Report (TAR) of the Intergovernmental Panel on Climate Change (IPCC), all emission scenarios based on the IPCC's fourth Assessment Report suggest that atmospheric particle accumulations, surface temperatures, and sea temperatures may rise throughout the 21st century; It predicts that land and sea ice and glaciers will decrease in area and volume. It is predicted that seasonality and latitudinal shifts in precipitation may occur as a result of some arid and semi-arid regimes becoming drier. It is predicted that precipitation may increase in Africa and Antarctica in winter and South and East Asia in summer. There are decreases in winter precipitation in Australia, Central America, and South Africa. According to the Hadley Center's climate models (UKMO/DETR, 1999) and the application of another model, significant reductions in water recharge and flows are expected for centuries to come, particularly for the Eastern Mediterranean basin and the Middle East. In the Northern Hemisphere, snow cover and sea ice spread are predicted to decrease. The Antarctic ice shield is expected to gain mass due to more precipitation, while the Greenland ice shield is expected to lose mass as the increase in flows is predicted to exceed precipitation (Türkeş, 2008). These climatic changes, together with the increase in temperature and decreases in precipitation regime, are expected to significantly affect Mediterranean agriculture, which is sensitive and based on irrigation (IPCC, 2013).

**Proceeding Book of ISESER 2023**

Accordingly, it is predicted that climatic changes will affect food availability and prices, restrict low-income societies' access to sufficient food, and even cause a food security problem (Türkeş, 2020). When the recent effects of climatic changes on the earth are examined, it has been observed that Turkey is among the risk group countries. In this context, some natural disasters (such as floods, storms, heat waves, extreme weather events, and forest fires) are expected to increase due to climate change (Türkeş, 2008). In addition, the Mediterranean Basin, which includes Turkey, is one of the regions where the effects of this global temperature increase will be widely seen. It is stated that the increase in temperature is expected to occur in the Mediterranean Basin in the near future and the decrease in precipitation will further reduce the already insufficient water resources and cause serious problems. The changes expected to occur in the total annual precipitation amount in the 2081-2100 period compared to the 1986-2005 average are presented in Figure 1 (IPCC, 2014).

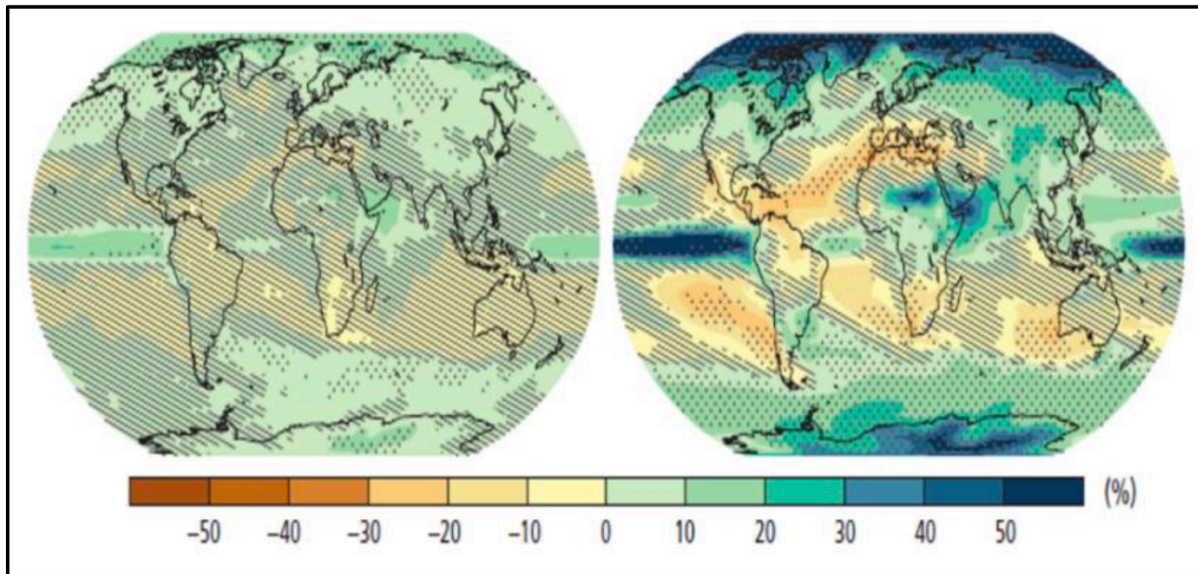

**Figure 1.** Expected changes in total annual precipitation for the period 2081-2100 (IPCC, 2014).

Viticulture, a significant branch of agriculture, is expected to be affected by climatic changes in different ways and levels. Sustainability and food safety must be ensured against the possible effects of climate change in the production of grapes and grape products with alternative evaluation methods such as table grapes, raisins, wine, grape juice, grape juice, molasses, and fruit pulp. Considering that the temperature increase will increase further in the future, it is estimated that the vineyard areas will show a latitudinal shift and the geography of viticulture will change significantly (Figure 2). In the Northern Hemisphere, it may increase towards the polar regions at intervals suitable for viticulture, but in the Southern Hemisphere, the viticulture may decrease and be prevented due to the lack of sufficient land areas (Soltekin et al., 2021).

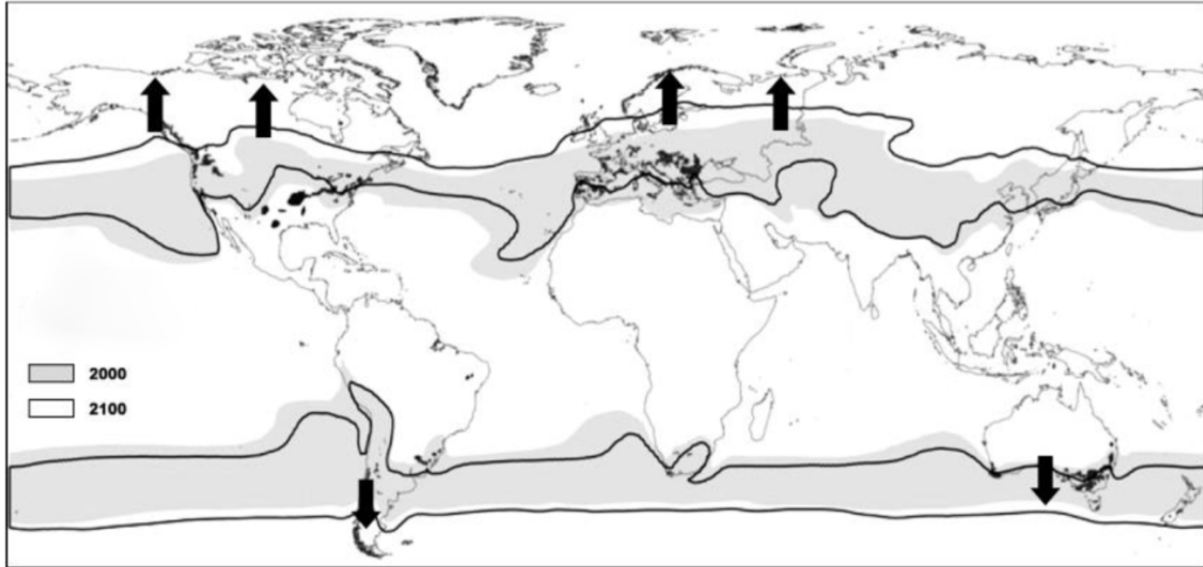

**Figure 2.** Effects of climate change on isotherms and viticultural zones (2000-2100) (Soltekin et al., 2021)

When we look at the studies conducted on the negative effects of climate change, it has been observed that marine protected areas are also greatly affected. Marine Protected Areas (MPAs) are one of the main management tools to ensure the conservation of biodiversity and achieve significant ecological and economic gains in marine ecosystems. However, the rapid expansion of marine ecosystems fueled by drivers of global change raises major concerns about the potential of MPAs to retain ongoing biodiversity. The climate of the oceans is linked to the distribution of ecosystems and more extreme climate events such as heat waves (MHWs) (as well as long-lasting normal warm water events). Heatwaves are increasingly being reported and benthic habitats in tropical and temperate ecosystems around the world are associated with severe mass mortality events (MMEs) of species. The effectiveness of MPAs is debated, as most existing MPAs were designed without considering climate change stressors. Considering this fear, climate-adapted management of MPAs (incorporating climate change into MPA design and management in various forms) has been proposed as a tool to confront climate change in the local environment. Managerial issues and global stressors may overlap with ongoing local threats. Even in areas where hunting is prohibited, the presence of uncontrolled, non-consumptive recreational activities such as SCUBA diving has been documented to be harmful. The main impact associated with the overcrowding of divers is direct physical damage to reef habitat-forming species such as corals, gorgonians, sponges, and bryozoans. Paradoxically, MPAs may attract more visitors from surrounding areas, although this local impact may be higher in MPAs than in non-protected areas (Zentner, 2023). The aim of Zentner's service on this subject in 2023 is to investigate how climate-adapted local measures and protection of coralligenous sections in MPAs can be improved. This is intended to increase survey and climate propagation in the Medes Islands, a small and extremely densely lit Mediterranean MPA (Zentner, 2023). She first carried out demographic monitoring of an important habitat brand, gorgonian (*Paramuricea clavata*), as the stress of climate change increases, especially heat waves and recreational diving, as well as their interaction. Secondly, it used field data to estimate the long-term viability of this species through size-structured matrix population models. Finally, it investigated how different climate and local management scenarios could enable the conservation of this important habitat-forming species (Zentner, 2023). In addition to all these, natural disasters and weather events, which are the most well-known effects of climate change, negatively affect people's psychological states and cause anxiety about the future (Fritze et al., 2008). According to the World Health Organization (WHO), health; can be used as a state of complete well-being, not only of illness or disability but also of the person's mental and social abilities (World Health Organization, 2005). In the 1986 Ottawa Health Promotion Agreement, it was emphasized that a person's physical, social, and mental capacity should be able to define himself and his environment, cope with negative stress situations, and meet personal comforts. However, according to this agreement, health sectors are

**Proceeding Book of ISESER 2023**

not solely responsible for health. Healthy lifestyles need to be adopted (World Health Organization (WHO), 1986). According to the Victorian Health Promotion Foundation Mental Health Promotion Framework, individuals' ability to achieve their goals, their social lives, their ability to express their emotions and their communication with other people can shed light on their mental health (Victorian Health Promotion Foundation, 2005). People's opinions about climate change are largely shaped by the media. Information on this subject may be found disturbing by some people and may cause emotional effects such as future anxiety, hopelessness, and fear. Again, although the negative effects of climate change are accepted by some individuals, they may be denied by some, especially if these negativities contradict their interests. Children and young people from all walks of life observe and experience the events around them differently than adults. For this reason, children and young people at these ages are likely to be confused about climate change and worried about the future (Fritze et al., 2008). As the effects of climate change on human health; Hygiene problems and resistance may occur due to heart diseases due to temperature increases, circulatory disorders, lung and respiratory diseases due to air pollution, and water shortage (Aras et al., 2020). While research on the effects of climate change on human health continues, some studies have also mentioned that it may have psychological effects. Natural disasters such as hurricanes, fires, earthquakes, tsunamis, and floods, which increase due to climate change, affect people in many ways. Depending on the frequency of exposure, people exposed to such natural disasters may experience withdrawal in their social lives, anxiety disorders (anxiety of losing loved ones, anxiety of losing their housing rights), and post-traumatic stress disorders (Galea et al., 2007). The psychological effects of climate change on humans have given rise to the term "eco-anxiety". Individuals worry about environmental disasters and the extinction of living things in the world, and the chronic fear and anxiety about this issue is called eco-anxiety. According to this research, the number of people who think that environmental cleanliness in Turkey will get worse is 39% of the population. The self-criticism of the climate that causes products to come about the environment, the climate against people caring about climate change, and the permission of climate conditions to be constantly exposed to content related to climate conditions, disruptions as important reasons that increase the climate affected by climate conditions (Hiwell Psychology, 2022). It has been argued that climate change is a threat to the mental and emotional health of all people. It turns out that the change in climatic conditions and the danger to the planet of young people can lead to negative emotions. A series of survey questions were asked of young people to obtain their opinions on this issue. In conclusion, despite increasing interest in climate change emotions among young people, there is a lack of research on the validity of measurements of such emotions. It has been demonstrated that more efforts are needed to develop survey tools to operationalize young people's feelings about climate change (Martin et al., 2023). Drought, which is a major problem in agriculture, is the negative impact of social and economic recovery. Due to drought, people engaged in agriculture may become unemployed, which increases stress in societies. A study was conducted in Australia about drought and its psychological effects. According to this research, there was an increase in the rate of hospital admissions due to depression among older people and young people living in rural areas. This observed increase was associated with drought (Yusa et al., 2015). In 2012, a heavy rainstorm brought floods to the highest peaks of Val Camonica, an Alpine valley in the Lombardy region of northern Italy. The downpour triggered a massive rockslide that plummeted to the valley floor 2,000 meters below, blocking the valley's main road with debris. A resident of the town in this region describes what it is like to live there now: "Living close to a place with a high risk of floods and landslides has of course led to a deterioration in my psychological health." People living in that area were asked questions about their experiences and generally received these answers. When people talked about the changes, they described how the changes affected their sense of well-being. "If the region and climate change, we have to adapt, and this causes anxiety and preoccupation," said one mountain resident. Such negative impact on mental health was also reported by other participants, young and old. Climate change is "Negative for my mood" and "Climate changes have affected me by slightly changing my mood towards the negative." "I adapt as I get used to the changes." A young man stated that he was more afraid than before, "I am more afraid of the effects of hail and wind for both the car and the garage and outdoor activities." Another mountain dweller said simply: "All these changes are making my well-being worse." Changes in weather and seasons are instead attributed to climate change, affecting people's sense of security, predictability and control, and triggering feelings of anxiety, distress, and uncertainty. Although people are noticing



**Proceeding Book of ISESER 2023**

significant changes in weather and climate right now, much of this anxiety and concern is directed toward the future (Whitaker, 2023).

Such psychological effects may differ in societies depending on the types of disasters and their destructive effects. In societies exposed to devastating disasters, emergency interventions, and health, economic, and social supports provided by governments also affect the mental health of societies positively or negatively (Fritze et al., 2008). Especially in countries with low education levels or low economies, accessing resources and accurate information is a problem. This problem also brings a feeling of insecurity and hopelessness. The level of poverty and mental health are directly related (WHO, 2004). For this reason, the psychological effects of climate change should not be underestimated. In the long term, its impact on societies can reach significant levels. The most common psychological response often observed after devastating disasters is acute traumatic stress. Such psychological symptoms decrease after disasters when individuals feel safe. In addition, chronic post-traumatic stress disorders (PTSD), prolonged mourning, depression, anxiety disorders, and increases in alcohol and drug use are observed in individuals who have lost their loved ones but survived themselves. It has also been observed that children have more severe psychological problems than adults. For example, during the Cold War, children thought they would not survive into adulthood, so it was known that they experienced hopelessness and anxiety about the future. Again, according to this research, individuals affected by Hurricane Katrina had a high rate of suicide and attempted suicide, domestic violence, and depression (Fritze et al., 2008). In a study conducted after Hurricane Floyd in North Carolina, an increase in child abuse was observed due to increased stress in parents and decreased social and economic support. Again, according to this research, it is assumed that drought has negative effects on mental health in the long term (O'Brien et al., 2014). The expansion at the clinical or subclinical level regarding the mental health effects of disasters, which are among the threats of climate change, is increasing in strength in different diversity and cultures (Crabtree, 2012). In 2007, Galea and colleagues conducted studies in Alabama, Louisiana, Mississippi, and New Orleans to understand the relationships between anxiety disorders and Hurricane Katrina. This survey-based research concluded that individuals, especially those living in the New Orleans area, experienced hurricane-related stress. Physical injury, illness, loss of life, and property are stated as stress factors (Galea et al., 2007).

**REFERENCES**

- Akbulut, M., Kaya, A. A. (2021). The Psychological Dimension of Global Climate Change. In *Gümüşhane Üniversitesi Sağlık Bilimleri Dergisi Derleme Makalesi GUJHS* (Vol. 10, Issue 3).
- Auer, C., Kriegl, E., Carslen, H., Kok, K., Pedde, S., Krey, V., Müller, B. (2021). Climate change scenario services: From science to facilitating action. *One Earth*, 1074-1082.
- Baran Barış ARAS, Kıvanç DEMİRCİ. (2020). *İklim Değişikliğinin İnsan Sağlığı Üzerindeki Psikolojik Etkileri*.
- Birpınar, M. (2022). Küresel Sorun İklim Değişikliği: “Gelişimi, Uluslararası Müzakereler ve Türkiye. *Çevre, Şehir ve İklim Dergisi*, 1(1), 20-36.
- Crabtree, A. (2012). *Australasian Journal of Disaster and Trauma Studies Climate change and mental health following flood disasters in developing countries, A review of the epidemiological literature: What do we know, what is being recommended?* (Vol. 2012, Issue 1).
- Fritze, J. C., Blashki, G. A., Burke, S., Wiseman, J. (2008). Hope, despair and transformation: Climate change and the promotion of mental health and wellbeing. *International Journal of Mental Health Systems*, 2. <https://doi.org/10.1186/1752-4458-2-13>
- Galea, S., Brewin, C. R., Gruber, M., Russell, M., Jones, T., King, D. W., King, L. A., McNally, R. J., Ursano, R. J., Petukhova, M., Kessler, R. C. (2007). Exposure to Hurricane-Related Stressors and Mental Illness After Hurricane Katrina. In *Arch Gen Psychiatry* (Vol. 64, Issue12).
- Hiwell Psikoloji. (2022, June 5). *Hiwell Psikoloji Instagram*. Hiwell Psikoloji.
- Hulme, M. (2009). *İklim Değişikliği Konusunda Neden Anlaşmıyoruz?* (K. Cankoçak, Ed.). Alfa Basım Yayım Dağıtım San. ve Tic. Ltd. Şti.
- IPCC, 2013. Climate Change 2013: The Physical Science Basis. Contribution of Working Group I to the Fifth Assessment Report of the Intergovernmental Panel on Climate Change. (Eds. Stocker et al.), Cambridge University Press, Cambridge and New York, 1535pp.

**Proceeding Book of ISESER 2023**

- IPCC, 2014. Climate Change 2014: Synthesis Report. Contribution of Working Groups I, II and III to the Fifth Assessment Report of the Intergovernmental Panel on Climate Change. (Eds. R.K. Pachauri & L.A. Meyer), IPCC, Geneva, Switzerland, 151 pp.
- Karadeniz, C. B., Aytan, N. (2019). The Possible Effects Of Climate Change On Eastern Black Sea Tourism. O. Üniversitesi içinde, *1. Uluslararası Eğitim ve Sosyal Bilimlerde Yeni Ufuklar Kongresi Bildiriler Kitabı*. İstanbul.
- Martin, G., Cosma, A., Roswell, T., Anderson, M., Treble, M., Leslie, K., Gislason, M. (2023). Measuring negative emotional responses to climate change among young people in survey research: A systematic review. *Social Science & Medicine*, 329.
- OBrien, L. v., Berry, H. L., Coleman, C., Hanigan, I. C. (2014). Drought as a mental health exposure. *Environmental Research*, 131, 181–187. <https://doi.org/10.1016/j.envres.2014.03.014>
- Soltekin, O., Altındışli, A., İşçi, B. (2021). İklim değişikliğinin Türkiye’de bağcılık üzerine etkileri. *Ege Üniversitesi Ziraat Fakültesi Dergisi*, 58(3), 457-467.
- Türkeş, M., (2001). “Hava, İklim, Şiddetli Hava Olayları ve Küresel Isınma”, T.C. Başbakanlık Devlet Meteoroloji İşleri Genel Müdürlüğü 2000 Yılı Seminerleri, Teknik Sunumlar, Seminerler Dizisi: 1, 187-205.
- Türkeş, M., (2008). Küresel iklim değişik- liği nedir? Temel kavramlar, nedenleri, gözlenen ve öngörülen değişiklikler. *İklim Değişikliği ve Çevre*, 26-37.
- Türkeş, M.T., 2020. İklim değişikliğinin tarımsal üretim ve gıda güvenliğine etkileri: Bilimsel bir değerlendirme. *Ege Coğrafya Dergisi*, 29(1): 125-149.
- Yusa, A., Berry, P., Cheng, J. J., Ogden, N., Bonsal, B., Stewart, R., Waldick, R. (2015). Climate change, drought and human health in Canada. In *International Journal of Environmental Research and Public Health* (Vol. 12, Issue 7, pp. 8359–8412). MDPI. <https://doi.org/10.3390/ijerph120708359>
- Zentner, Y., Rovira, G.-I., Margarit, N., Ortega, J., Casals, D., Medrano, A., Linares, C. (2023). Marine protected areas in a changing ocean: Adaptive management can mitigate the synergistic effects of local and climate change impacts. *Biological Conservation*.
- Victorian Health Promotion Foundation. (2005). *Victorian Health Promotion Foundation (VicHealth): A Plan for Action 2005–2007: Promoting mental health and wellbeing*.
- Whitaker, S. H. (2023). “The forests are dirty”: Effects of climate and social change on landscape and well-being in the Italian Alps. *Emotion, Space and Society*, 49.
- World Health Organisation (WHO). (1986). *World Health Organisation (WHO): Ottawa Charter for Health Promotion. First International Conference on Health Promotion*.
- WHO. (2004). *Promoting mental health: concepts, emerging evidence, practice: summary report*.
- World Health Organisation. (2005). *World Health Organisation (WHO): Promoting Mental Health: Concepts, Emerging Evidence, Practice*.

**O 13. CONSTRUCTION WASTE MANAGEMENT: KEY STUDY OF SKOPJE**

Zoran SAPURIC<sup>1\*</sup>, Dame DIMITROVSKI<sup>2</sup>, Sukru DURSUN<sup>3</sup>, Filip IVANOVSKI<sup>1</sup>

<sup>1</sup>*University American College, Skopje, N. Macedonia.*

<sup>2</sup>*University St. Cyril and Methodius, Skopje Faculty of Mechanical Engineering.*

<sup>3</sup>*Konya Technical University, Turkey*

E-mail: [sazoran@hotmail.com](mailto:sazoran@hotmail.com)

**ABSTRACT:** Waste is one of the biggest environmental problems. Waste generation has been increasing. Contemporary waste management covers the minimization of waste and after that recycling and reuse and other forms of recovery. Waste disposal is the least favorable option. In the frame of waste construction waste has a significant part of total waste generation, which seriously affects the environment. The construction sector generates about 33% of the total waste in the EU. In North Macedonia and in the capital city of Skopje construction waste generation also has been increasing. This waste frames waste from construction, renovation, demolition, and other activities. It contains various materials such as many types of metal, glass, wood, concrete, and many other components. Construction waste has a big potential for economic and environmental benefits. In Skopje, the amount of collected construction waste is about 330 tons of which 34 tons belong to asbestos waste which is hazardous waste. The amount of reusing and recycling is on a low level. Proper construction waste management can contribute to the development of the circular economy. N. Macedonia and its capital city Skopje has an obligation to follow and implement the EU standards and regulation in the sphere of waste including construction waste.

The main goal of this paper is to analyze possibilities for improvement of construction waste management and use its potential towards to circular economy. Also, the paper aims to analyze regulation in this sphere and to propose the improvement of this regulation as a precondition for sustainable construction waste management.

*Keywords: Waste, Construction, Management, Circular Economy, Regulation*

## **1. INTRODUCTION**

The construction sector plays an important role in the Macedonian, s economy. It generates about 8 % of the national GDP In the technical structure of investments in fixed assets, construction works participate with 50.% (State Statistical Office 2022). Construction is also a significant consumer of intermediate products (raw materials, chemicals, electrical and electronic equipment, etc., and related services). Because of that, the construction sector can significantly influence the development of the overall economy. Construction including demolition produces a significant volume of waste. This waste contains a wide variety of materials such as concrete, ceramics, bricks, asphalt, wood, paints, glass, various metals, plastic, and other components that can be reused, recycled, and recovered. Sustainable construction waste management can contribute to the development of the circular economy. Sustainable waste management is very important for a circular economy, which is crucial for sustainable environmental protection and economic development. A circular economy has a big potential for economic growth, opening new jobs, and development of new technologies. It understands waste minimization and reuse, recycling, and other recovery of all waste streams and only as an exception landfilling. Most of the construction waste is non-hazardous. However, some of this waste can contain hazardous elements, such as lead, asbestos, plasterboard, paint thinners, strippers, fluorescent bulbs, and aerosol cans. These can pose particular risks to the environment and impede recycling. This produces problems for the use of its potential. Sustainable construction waste management covers proper following and designing of construction waste chains. In general, a waste chain is defined as the full range of activities that firms undertake to bring a product or a service from its conception to its own. It begins with design, transport, storage, distribution, building activities, and demolition, to the end of its life cycle. Separation of hazardous elements on a source is important for the use of this waste.

Waste is a big contemporary global problem ( Wolf & Stainley 2011). N. Macedonia and its capital city Skopje and Skopje region should follow and implement the EU standards and regulations in the

## **Proceeding Book of ISESER 2023**

sphere of waste including construction waste. The process of implementation of this regulation gives some positive results, but problems appear with its practical implementation (Sapuric & Dimitovski 2015). Besides some progress, the country, as well as its capital city Skopje, and Skopje region, faces numerous problems with waste management. The first steps of construction waste management in the Skopje Region have been performed.

## **2. MATERIAL AND METHODS**

The research that has been done in the process of preparation of this paper has analyzed the legal, strategic, and planning documents of the EU and N. Macedonia, as well as the reports and documents of Skopje. Also, there were analyzed the relevant studies. The interviews with relevant experts have been performed. Statistical data both on the EU and national levels have been collected and analysed.

Relevant published literature has been reviewed. The conditions in the Skopje region were compared with the conditions in other regions in the country and in the EU. Also, it has prepared a SWOT analysis, which includes strong and weak points, as well as opportunities and threats.

## **3. RESULTS AND DISCUSSION**

Skopje region includes the city of Skopje and 10 municipalities in the frame of the city and 7 municipalities around the city.

The population in the Skopje region according to the 2021 census is 607.007 inhabitants or 33.04 % of the total residential population in the country, which is 1,836.713 and it is the most populated region in the country. (State Statistical Office 2022). The Skopje region is the smallest on the surface with 1.802 square kilometers and covers 7.3% of the total area of the country.



**Picture 1 .** Map of N. Macedonia and Skopje region.

The country as well as the Skopje region makes efforts to improve waste management including construction waste according to the EU regulations and standards by using the experiences and support from the EU.

The EU Waste Framework Directive (Directive 2008), as a most important part of EU waste legislation, determined very ambitious goals to recycle and reuse 70 % of construction and demolition-generated waste. It is not for now released in most EU countries, but the EU remains strongly dedicated to sustainable construction waste management. The EU waste legislation has been transposed into the Macedonian legislation. The most important is the Law on waste management (Law 2021). It is a basic law in the waste sphere and regulates the general principles for all types of waste management. The law defines construction waste as inert waste, which is waste that is resistant and does not undergo significant physical or chemical transformations, does not dissolve, does not burn and does not react in any other physical or chemical way, does not biodegrade, and cannot endanger the environment. Construction debris is defined as waste during construction and demolition.

**Proceeding Book of ISESER 2023**

Proper management of hazardous waste still presents a problem in the Union, and data on its treatment are partly missing. EU countries have different results in the selection recycling and reuse of construction waste. Construction and demolition waste is the biggest waste stream in the EU by weight, accounting for over 800 million tonnes per year, i.e., around 32 % of the total waste generated (EU Commission 2018). Greenhouse gas emissions from material extraction, manufacturing of construction products, and construction and renovation of buildings are estimated at 5-12% of total national GHG emissions.

Table 1 shows the structures of waste generation in the EU and the different streams of waste management in the EU countries. Table 2 explores the data from the EU countries and non-EU European countries, including N. Macedonia, for total waste generation from economic activities and households.

The figures from table 1. and 2. show that the EU countries have different results in establishing sustainable waste management in all waste streams. Those are also the data from non-EU countries including Macedonia. According to this in 2020, in Macedonia construction waste, including demolition waste is about 3,8 % of whole waste generation from economic activities and households. However, it is worth mentioning that there are still problems with data collection and precise waste evidence from all waste streams in Macedonia including construction waste. This also applies to the Skopje region.

**Table 1.** the EU countries have different results in establishing sustainable waste management in all waste streams.

**Waste generation, excluding major mineral waste, EU, 2004-2020**  
(million tonnes)

	2004	2006	2008	2010	2012	2014	2016	2018	2020	Change 2020/2004 (%)
<b>Total</b>	779.5	789.9	760.5	758.7	758.3	769.0	784.6	812.9	776.3	-0.4
<b>Agriculture, forestry and fishing</b>	62.3	56.7	45.5	20.2	20.4	17.7	19.7	19.4	20.7	-66.7
<b>Mining and quarrying</b>	10.4	7.1	10.0	7.9	7.5	7.7	6.9	8.1	7.5	-28.3
<b>Manufacturing</b>	239.9	225.8	216.8	190.5	176.4	176.0	179.0	179.8	166.6	-30.5
<b>Energy</b>	85.4	93.3	84.1	78.6	88.8	87.4	74.7	75.7	45.7	-46.5
<b>Waste/water</b>	75.2	83.3	98.9	129.9	155.0	180.7	196.8	208.5	212.4	182.3
<b>Construction</b>	34.4	33.4	34.8	42.1	39.8	38.6	37.8	41.3	38.7	12.5
<b>Other sectors</b>	97.7	111.2	88.7	103.5	89.6	85.1	88.5	94.0	89.0	-8.9
<b>Households</b>	174.1	179.2	181.6	186.0	180.7	175.9	181.2	186.1	195.7	12.4

Source: Eurostat (online data code: env\_wasgen)



According to the data of the State Statistics Office ( Anonym 2022), in the country in 2020, the total amount of waste generation by section of economic activity was 1,488,000 tonnes. Of the total generated waste, 71.90% was non-hazardous and 28.10% was hazardous waste. The greatest share of the generated waste was from the section of mining and quarrying, 521,000 tonnes (35.03%). The amount of recycled waste or waste delivered for recycling was 538,000 tonnes. By the waste types recycled or delivered for recycling, the greatest amount was from the category of metallic wastes, non-ferrous, paper and cardboard wastes, and plastic wastes.

Regarding the amount of communal waste, the total amount of collected municipal waste is 605,638 tonnes, 84% from the households and remaining 16% from companies. The largest amount of collected communal waste was recorded in the Skopje region, or 172,288 tonnes. Table 3 shows the structure of municipal waste in the Skopje region.

**Proceeding Book of ISESER 2023**

**Table 2.** the EU countries have different results in establishing sustainable waste management in all waste streams

**Waste generation by economic activities and households, 2020**  
(% share of total waste )

	Mining and quarrying	Manufacturing	Energy	Waste/water	Construction and demolition	Other economic activities	Households
EU	23.4	10.6	2.3	10.8	37.5	5.9	9.4
Belgium	0.0	20.9	1.5	31.4	30.5	7.9	7.8
Bulgaria	81.6	4.2	5.2	2.9	1.6	2.5	2.0
Czechia	0.3	12.1	1.1	15.5	42.9	12.2	15.9
Denmark	0.1	5.4	3.9	7.5	54.8	10.3	18.0
Germany	1.3	13.7	2.0	12.0	56.3	5.1	9.6
Estonia	15.2	24.6	35.0	4.6	9.8	7.4	3.4
Ireland	9.4	22.4	1.0	12.6	32.6	10.1	12.0
Greece	31.7	11.1	5.3	11.4	19.1	5.5	15.9
Spain	2.3	12.4	0.8	20.8	30.8	11.5	21.3
France	0.1	6.0	0.3	8.1	68.5	6.3	10.8
Croatia	11.6	7.5	1.1	16.3	23.8	19.5	20.2
Italy	0.8	15.2	0.9	24.6	37.8	4.1	16.6
Cyprus	6.9	9.5	0.1	6.6	50.2	9.8	17.0
Latvia	0.0	17.0	4.1	33.7	9.7	12.9	22.6
Lithuania	1.0	32.7	2.3	18.4	8.3	16.3	20.9
Luxembourg	1.1	6.5	0.3	3.5	82.1	4.2	2.2
Hungary	0.8	15.2	11.4	12.1	25.4	7.5	27.6
Malta	1.1	0.9	0.0	2.5	85.3	4.7	5.6
Netherlands	0.1	10.6	0.4	7.4	65.4	8.7	7.4
Austria	0.1	7.5	0.6	3.5	76.5	5.2	6.7
Poland	36.6	16.1	6.6	13.4	13.0	6.6	7.8
Portugal	0.1	17.8	1.3	22.9	10.7	15.4	31.8
Romania	84.3	4.6	3.1	2.0	0.9	2.2	3.0
Slovenia	0.1	17.9	12.1	3.8	6.3	51.4	8.4
Slovakia	1.6	24.0	5.5	8.9	9.0	32.5	18.5
Finland	75.1	8.2	0.8	1.0	11.8	1.0	2.1
Sweden	76.5	3.1	1.2	4.5	9.3	2.3	3.1
Iceland	0.0	24.2	0.0	2.0	3.6	31.0	39.2
Liechtenstein	0.0	1.1	0.0	0.3	92.5	0.1	6.0
Norway	1.3	13.6	1.6	8.0	44.2	12.9	18.4
Montenegro	25.3	2.5	29.0	0.3	13.8	10.5	18.5
North Macedonia	35.1	35.0	0.5	17.9	3.8	7.7	0.0
Serbia	78.0	1.9	13.5	1.1	1.2	0.9	3.5
Türkiye	25.6	19.2	22.6	0.3	0.0	5.8	26.5
Bosnia and Herzegovina	11.3	27.3	46.3	0.0	1.3	0.4	13.4
Kosovo (!)	19.9	9.4	52.5	0.3	0.2	3.1	14.6

(!) This designation is without prejudice to positions on status, and is in line with UNSCR 1244/1999 and the ICJ Opinion Declaration of Independence.

Source: Eurostat (online data code: env\_wasgen)



Table 3 shows that the highest percentage of collected communal waste or 81,68% is mixed waste which shows that separated waste selection and collection is still at a low level. As mentioned above in the state the percentage of construction waste is 3,8 % of total waste generation, excluding the generation of waste from excavated soil. But as mentioned above there are still problems with waste data evidence in the country and even more with construction waste the problems are bigger. The Annual 2022 report from Public Enterprise “ Drisla Skopje“ ( Report 2022), which operated with Skopje regional landfill Drisla, noted that in 2022 collected and disposed of 33,216 tonnes of construction waste ( excluding from excavated soil). Also in 2022, 203 tons of asbestos waste, mostly construction waste was collected and disposed. That shows that there is no precise data and precise road map related to construction waste and it has to be based on some estimations. Because of this, there are differences in construction waste data.

**Table 3.** Waste composition in the Skopje region

Waste type	Average collected waste in tonnes	%
Papers	12,178	2,01
Glass	3,754	0,62
Plastic	13,063	2,16
Metal( iron, still, aluminum, etc.)	2,302	0,38
Organic waste food, leaves, greenery, etc)	40,259	6,65
Textile	8,373	1,38
Ruber	1,487	0,25
Mixed waste	494,693	81,68
Other	29,531	4,88

**Proceeding Book of ISESER 2023**

According to an estimation from 2021, the amount of construction waste in the Skopje region is based on two scenarios. According to the lower scenario, the amount is about 250,000 tonnes and the higher scenario is even about 350,000 tons.. The estimation is that generation waste from excavated soil in the Skopje region is between 1,000,000 and 1,200,000 tons. It is worth mentioning that construction waste depends on different construction activities, which are very variable from year to year. Furthermore, The Plan for Waste Management of Macedonia for 2021- 2031 noted that the estimated amount of construction waste is about 500,000 tonnes (Anonym 2021). It means that only about 10% of construction waste was collected This Plan defines construction waste as a priority waste stream.

At the landfill Drisla there is a a site with a facility for the proper storage, processing, and treatment of asbestos waste. There is a plant with a specially designed and managed cell for the disposal of asbestos waste. A cell can accommodate 100,000 m<sup>2</sup> of asbestos tiles. Those tiles should be packed in protective bags with dimensions 1m x 1m x 70 cm. The situation with the processing of construction waste in the Skopje region will be significantly improved with the procurement of a machine for crushing certain types of waste, such as concrete, bricks, plaster, and similar waste, with the capacity of processing 10,000 tons of construction waste monthly. It will be satisfactory for processing a significant part of collected construction waste. whole collected waste from the Skopje region. That should be performed by the end of 2024.

In the near future, has to be established completely following the construction waste chain from the production, storing, mapping, and construction activities to the end of its “life”, by recycling, processing, reusing, or disposal as a least favorable option. It should also reach progress in the system of waste sorting at the generation place and a phased approach and progress with new infrastructure and equipment. In the first place, it should be at least for wood, concrete, bricks, ceramics, plastic, stones, and plaster. Extended producer responsibility has to be enhanced.

A SWOT analysis made in the research of preparing this paper shows, strong and weak sides, and also opportunities and threats.

**Table 4. SWOT analysis**

Strong sites	Weakness	Opportunities	Threats
Developed distribution system, possibilities from using EU funds, exiting regulation, developed a legal system for fees for improperly behavior with waste, revenue streams are not directly dependent on material price fluctuations, direct customer relations, use of the existing distribution/collection system.	Distance from waste source to processing place still does not satisfy specialization in construction waste management, undeveloped infrastructure, and lack of equipment.	Further, strengthen regulation, strengthen stimulation, public-private partnership, stimulate private companies, and increase demand for recycled products.	Lack of market acceptance of recycled materials, non-development market, high cost of recycling, contamination of input material streams with hazardous substances, and low public awareness.

**4. CONCLUSIONS**

Construction waste contains a very valuable component. Sustainable construction waste management can contribute to the development of a circular economy, create new jobs, develop new technologies, and better protection of the environment. This management has to be supported by economic instruments. The improvement of construction waste management should be developed in phases, with the improvement of infrastructure and supplying the equipment. Waste management in the Skopje region has to improve: waste identification, source separation, and collection, improve waste logistics and waste processing, and involve quality management. The private sector should be strongly involved. All relevant sectors such as the business sector, science, and local and central government should cooperate in aim to establish an efficient system of management of this waste stream.

**Proceeding Book of ISESER 2023**

**REFERENCES**

- Anonym, Plan for Waste Management of Macedonia for 2021- 2031, chrome-extension://efaidnbmnnnibpcajpcglclefindmkaj/https://www.moepp.gov.mk/wp-content/uploads/2021/10/ -%D0%B3%D0%BE%D0%B4%D0%B8%D0%BD%D0%B0.pdf
- Anonym,chromeextension://efaidnbmnnnibpcajpcglclefindmkaj/https://www.stat.gov.mk/pdf/2022/9.1.22.01\_mk.pdf
- Directive 2008/98 / EC, on waste and repealing certain Directives, Official Journal of the EU, L 312/3, amended by Directive 2018/851 EU, Official Journal of the EU, 312/22.
- European Commission, (2018), Report from the Commission to the European Parliament, the Council, the European Economic and Social Committee, and The Committee of the Regions, on the implementation of EU waste legislation, including the early warning report for Member States at risk of missing the 2020 preparation for re-use/recycling target on municipal waste, Brussels, COM (2018) 656.
- Law on waste management. Official Journal of RSM, 216/2021.
- Public Enterprise, “ Drisla Skopje “ Overall 2022 operation report, No.02 680/5, 31.05. 2023.
- Sapuric Z, & D. Dimitrovski (2015), Urban Waste Managemen: A Key Study of Skopje *J.Inter. Appl & Sci vol. Vol. 10 – 2. p.p 218-223.*
- State Statistical Office, (2022), Statistical Year Book of the Republic of North Macedonia.
- Wolf & Stainley (2011), Environmental Law, Fifth Edition, p.p 74-75, Routledge, New York.



**Proceeding Book of ISESER 2023**

**O 14. INVESTIGATION OF THE CHANGE IN THE USE RATES OF NON-RENEWABLE ENERGY RESOURCES, WHICH HAVE A MAJOR ROLE IN AIR POLLUTION IN KONYA PROVINCE, BY YEAR**

Fatma KUNT<sup>1</sup>, Mustafa Cihan ÇELEBİ\*<sup>1</sup>, Zeynep Cansu AYTURAN<sup>2</sup>, Noor Zaitun YAHAYA<sup>3</sup>

<sup>1</sup>*Necmettin Erbakan University, Environmental Engineering Department, Engineering Faculty, Konya, Türkiye*

<sup>2,3</sup>*Environmental Engineering Department, Engineering and Natural Science Faculty, Konya Technical University, Konya, Türkiye.*

<sup>4</sup>*Faculty of Ocean Eng. Technology and Informatics, University Malaysia Terengganu Malaysia.*

E-mail: [mccelebi10@gmail.com](mailto:mccelebi10@gmail.com)

**ABSTRACT:** In the universe we live in, air pollution is now reaching the level of affecting not only living life but also the entire cycle on an objective basis. Therefore, it is necessary to realize pollutant factor limits with strict measures with global unity. Establishing incentive policies for the use of renewable, clean energy resources with global unity will ensure a healthier society and a strong economy. Almost all scientific authorities agree that the world is getting warmer and that this warming has a negative impact on air quality and the life cycle. This situation, called global climate change, is seen as one of the biggest environmental and socioeconomic phenomena threatening our century. In this context, "the effects of greenhouse gases on climate change" is a topical issue in today's world and occupies a very large place in today's air pollution population. Among a number of factors that cause air pollution, the most important ones are undeniably non-renewable energy sources. The aim of this study is to investigate the role of non-renewable energy sources, which are among the biggest parameters causing air pollution in Konya province, and how much the usage rates have changed over the years.

*Keywords: Konya, Air Pollution, Non-Renewable Energy sources*

## **1. INTRODUCTION**

Konya has 2.75% of Turkey's total population with a population of 2,296,347 as of 2022. It ranks 7th among 81 provinces in terms of population and gross domestic product (GDP) (2.1% of Turkey's GDP), and is the largest province in Turkey in terms of surface area. Konya province is a city with 13 organized industrial zones, 9 of which are active, and a total of 77 industrial sites, including 17 small industrial sites. Especially the industrial enterprises operating in Konya have a lot of sectoral diversity in terms of the number of workplaces. Konya has 45% of the domestic market in the metal processing. It can produce 90% of the parts used in tractors and 100% of the parts used in agricultural machinery and holds 65% of the domestic market in this field. In the automotive sub-industry sector, more than 70% of the parts and equipment of many brand models are produced in Konya. Konya provides 10% of Türkiye's grain production. Ethyl alcohol production alone meets 56% of our country's needs. 20% of the city's electricity consumption is met by renewable energy sources. In Konya, which has made significant progress in sectoral diversity, the number of enterprises registered in the industrial registry, which was 8,439 in 2020, reached 9,044 as of 2021. Rapid economic growth, urbanization, population growth and increasing welfare levels in our country cause an increasing need for energy (ÇŞİDB, 2018; ÇŞİDB, 2019; ÇŞİDB, 2020; ÇŞİDB, 2021; ÇŞİDB, 2022). Our limited natural resources have become unable to meet our unlimited needs. Increasing the number of sensitive consumers by ensuring that our people adopt a sustainable lifestyle, Our first duty is to ensure efficient use of our natural resources by preventing waste, to focus on renewable energy sources in every field rather than those that cannot renew themselves, and to reduce environmental risks and contribute to the economy (KTO (Konya Ticaret Odası), 2022). Cities where population, production and consumption are dense have high vulnerability due to their effects on air pollution. Cities affect not only their own borders, but also a large area with which they interact as a result of activities such as trade and transportation. Cities where economic activities and assets are concentrated are also exposed to disaster risks caused by air pollution and experience significant socio-economic losses. The population of cities around the world continues to increase rapidly, and it is predicted that the urban population will be 8.5 billion in 2030, accounting

## **Proceeding Book of ISESER 2023**

for more than 70% of the total world population. In Turkey, while the total population increased 4.5 times between 1940 and 2022, the population living in cities increased 11.5 times until 2007, which was before Law No. 5747. In Turkey, in 2022, the ratio of those living in provincial and district centers to the total population was reported as 93.4%, and the ratio of those living in towns and villages to the total population was reported as 6.6%. Based on these data, it can be seen that the majority of the population lives in cities. In order to meet the ever-increasing needs in cities, the use of non-renewable energy sources, especially fossil fuels, is starting to increase every year. As a result of these uses, the world's own resources are coming to the point of depletion, and as a result of its use, it causes air pollution at visible levels and threatens living life. It is aimed to provide an infrastructure regarding the inventory, usage areas and usage rates of non-renewable energy resources by conducting a literature study in order to determine both the use of non-renewable energy resources, the quantitative change over the years and the negative impact on air pollution in this process sector (TUİK, 2023; EPDK, 2018-2022a; EPDK, 2018-2022b, EPDK, 2018-2022c).

## **2. MATERIALS AND METHODS**

In this study, the use rates of non-renewable energy resources, which are an important problem on the planet in Konya province, will be investigated, their effects on air pollution will be examined, and the findings will be discussed and the results will be discussed by revealing the official values in quantitative terms. The detailed content of the subject of the research is to examine the rapid increase in the world's population, the increase in the level of industrialization with the development of technology, and the emergence of more energy needs, and their role in air pollution. Energy consumption, which is an indicator of the development level of countries, has become an important issue that must be kept under control. In order to use energy effectively in industry and industry, efficient use of existing energy production systems, finding cheap and clean energy sources alternative to fossil-based energy sources, minimizing and eliminating negative environmental impacts are among the topics that are intensively researched today. Fossil-based energy resources are used extensively in all cities around the world to meet most of their energy needs, either directly or by converting them into electrical energy. Fossil-based energy production and use cause many negative effects on human and environmental health. The use of fossil fuels for heating, power generation, in motor vehicles, industrial processes and by burning solid fuels are the main sources of air pollutants released into the atmosphere in cities. The most common pollutants in the urban environment are sulfur dioxide (SO<sub>2</sub>), nitrogen oxides (NO or NO<sub>2</sub>, often called NO<sub>x</sub>), carbon monoxide (CO), ozone (O<sub>3</sub>), particulate matter (PM) and lead (Pb). It is exceeding. As a result of the emission of CO<sub>2</sub>, which is the inevitable product of the combustion technology on which fossil fuel use is based, the amount of CO<sub>2</sub> in the atmosphere has increased approximately 1.3 times in the last century and is gradually increasing. In the next 50 years, this amount is likely to increase 1.4 times compared to today. Due to the greenhouse effect caused by carbon dioxide in the atmosphere, the world's average temperature has been 17.23 °C in the last century. In addition, the use of fossil-based solid fuels for heating is an important source of these pollutants. Air pollution in our cities increases, especially with the beginning of the warming period. Using low-quality coal for heating, not using appropriate combustion systems, applying incorrect combustion techniques and not performing regular operating maintenance of the boilers used are the main causes of air pollution caused by heating in winter. Since 2021, in the regions where solid fuel use has been intense in Konya province, under the leadership of the Ministry of Environment, Urbanization and Climate Change and Konya Metropolitan Municipality Climate Change and Zero Waste Department, natural gas installations have been installed in the houses of lower socioeconomic levels that receive coal aid under the name of clean transformation, and the use of solid fuel has been terminated (ÇŞİDB, 2018; ÇŞİDB, 2019; ÇŞİDB, 2020; ÇŞİDB, 2021; ÇŞİDB, 2022). Concrete steps have been taken to improve air quality. The areas of use of non-renewable energy resources in Konya are discussed in three main categories: industry, transportation and housing.

Sulfur dioxide (SO<sub>2</sub>), a colorless gas released as a result of the use of non-renewable resources, is oxidized as sulfate and sulfuric acid after reaching the atmosphere. It forms droplets or solid particles that can be transported over great distances along with other pollutants. SO<sub>2</sub> and its oxidation products are removed from the atmosphere by dry and moist deposition (acidic rain). Another pollutant parameter is nitrogen oxides (NO<sub>x</sub>). The sum of nitrogen monoxide (NO) and nitrogen dioxide (NO<sub>2</sub>) creates nitrogen oxides (NO<sub>x</sub>). Nitrogen oxides are generally (in 90% case) exhaled as NO. It is formed as a result of the reaction of NO and NO<sub>2</sub> with ozone or radicals (such as OH or HO<sub>2</sub>). NO<sub>2</sub> is one of the

**Proceeding Book of ISESER 2023**

most important air pollutants in urban areas as it is the type of nitrogen oxide that affects human health the most. Nitrogen oxide (NOX) emissions occur from human-created sources. Carbon monoxide (CO), released as a result of the use of solid fuel, which is the leading non-renewable energy source, is an odorless and colorless gas. It occurs as a result of the incomplete combustion of carbon in the fuel structure. CO concentrations typically reach their highest value during cold seasons. It reaches very high values in cold seasons (Konya Valiliği & Konya Büyükşehir Belediyesi, 2013-2019).

In line with the materials and methods used in the study, the usage areas, rates and changes over the years of non-renewable energy resources that cause air pollution by releasing these pollutants are given in the findings section with materials such as graphics and tables. Within the scope of this research, the materials used are year-end activity reports shared by official institutions, status reports, economic reports, simulations made on the web, monitoring parameters, panels, TUIK data, files shared by private companies that play a role in the distribution and sale of energy resources, and periodical data. reports, information sharing documents between institutions, books, magazines, articles and theses on the subject were used.

**3. RESEARCH FINDINGS**

Quantitative changes in the non-renewable energy resources natural gas, diesel, gasoline, LPG, fuel oil, kerosene and coal, which were discussed within the scope of the research, in the last 5 years were examined as a result of the annual activity reports shared by the Energy Market Regulatory Authority. The data obtained are classified and presented below in graphs and tables.

**3.1. Natural Gas Usage**

In Figure 1 usage of natural gas in Konya during the last 5 years is given. When we examine the amount of natural gas sold and used in Konya in the last 5 years, we see that there is an increase of 42.8%.

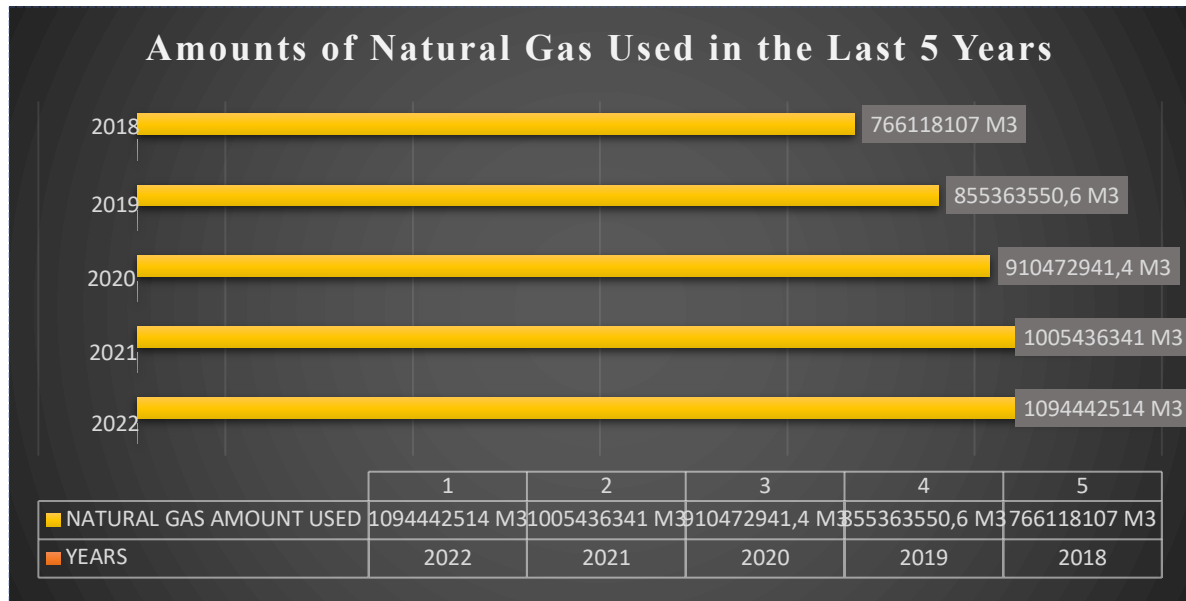

**Figure 1.** Schematic Representation of Natural Gas Usage by Years (TUIK, 2023; EPDK, 2018-2022a; EPDK, 2018-2022b, EPDK, 2018-2022c).

**3.2. Diesel Usage**

In Figure 2 usage of diesel in Konya during the last 5 years is given. The use of diesel fuel in Konya has fluctuated in the last 5 years, and the amounts have varied depending on the farmer's crop style and working status.

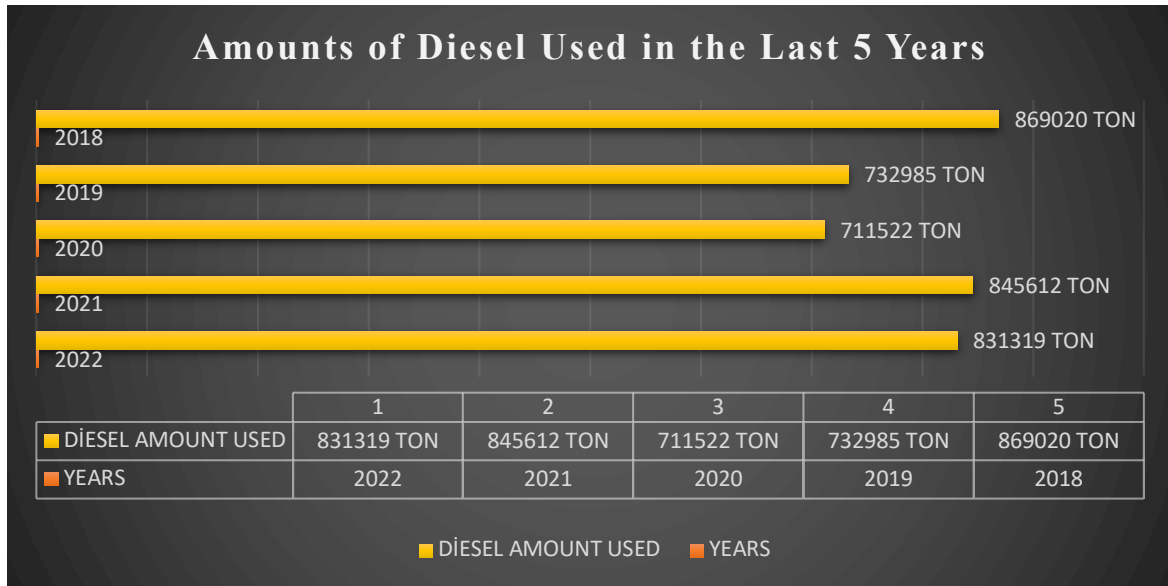

**Figure 2.** Schematic Representation of Diesel Usage by (TUİK, 2023; EPDK, 2018-2022a; EPDK, 2018-2022b, EPDK, 2018-2022c).

### 3.3. Gasoline Usage

In Figure 3 usage of gasoline in Konya during the last 5 years is given. When we examine the amount of gasoline sold and used in Konya in the last 5 years, we see that there has been an increase of 34.5%.

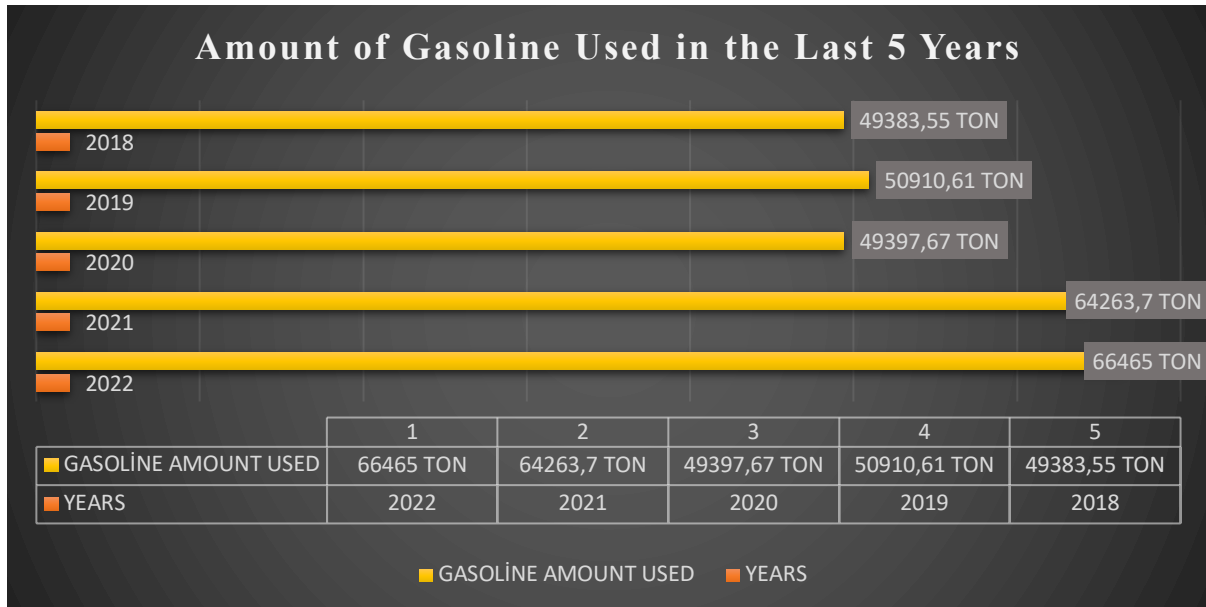

**Figure 3.** Schematic Representation of Gasoline Usage by Years (TUİK, 2023; EPDK, 2018-2022a; EPDK, 2018-2022b, EPDK, 2018-2022c).

### 3.4. LPG Usage

In Figure 4 usage of LPG in Konya during the last 5 years is given. LPG usage in Konya has fluctuated in the last 5 years, with increases in some periods and decreases in other periods.

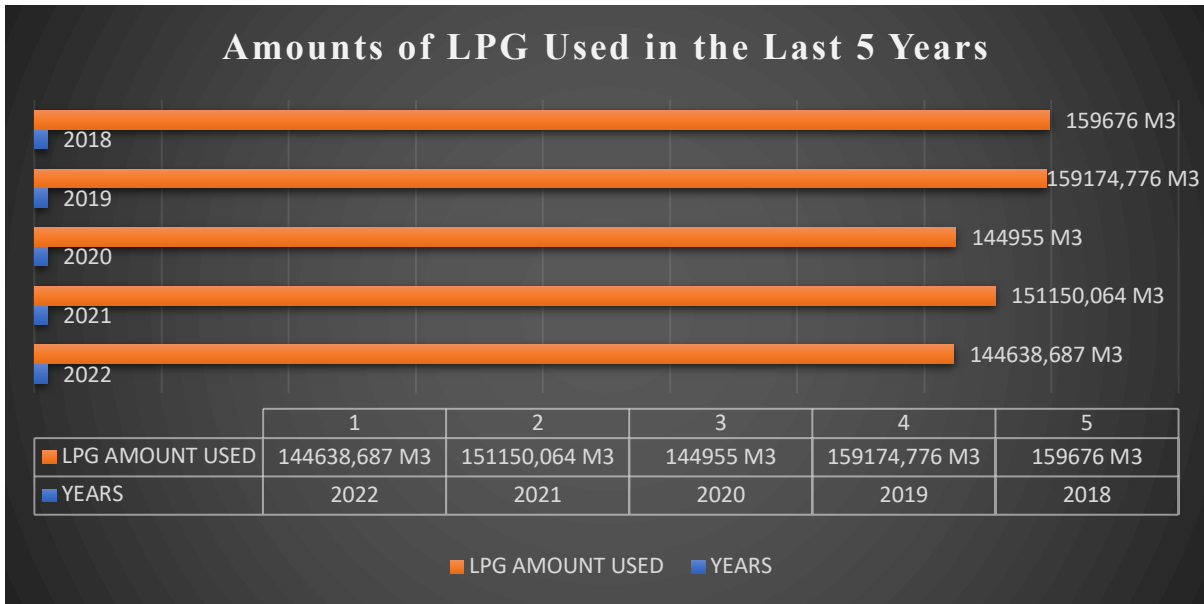

**Figure 4.** Schematic Representation of LPG Usage by Years (TUİK, 2023; EPDK, 2018-2022a; EPDK, 2018-2022b, EPDK, 2018-2022c).

### 3.5. Fuel Oil and Kerosene Usage

In Figure 5 usage of fuel oil and kerosene in Konya during the last 5 years is given. Fuel oil use in Konya has increased by 64.2% in the last 5 years and gas oil use has decreased by 47.5%.

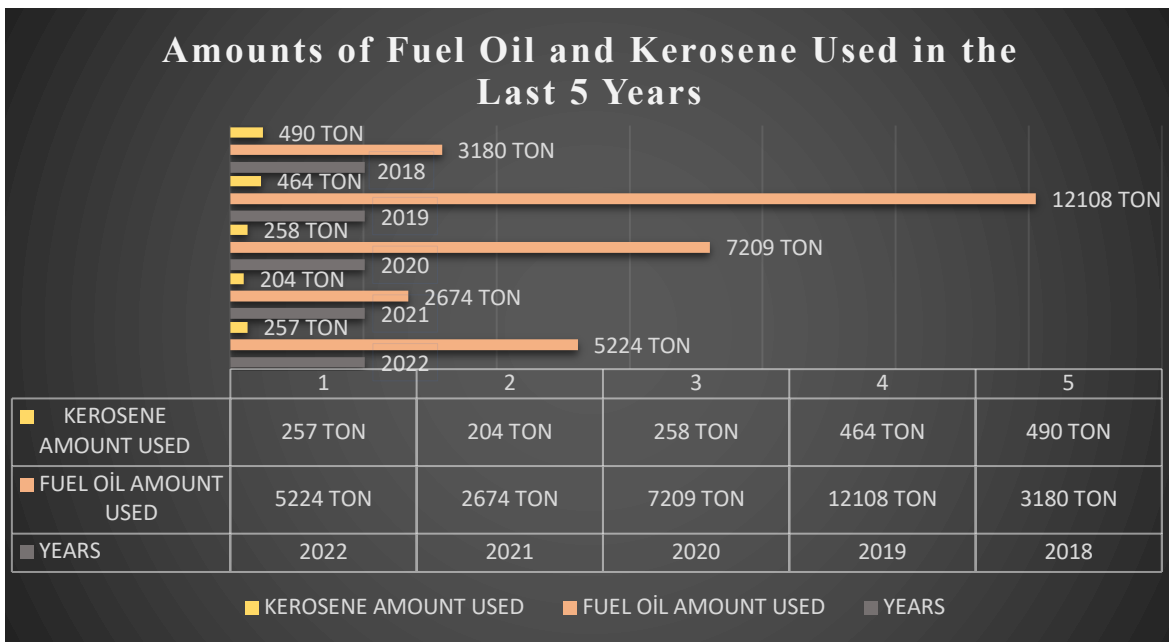

**Figure 5.** Schematic Representation of Kerosene and Fuel Oil Usage by Years (TUİK, 2023; EPDK, 2018-2022a; EPDK, 2018-2022b, EPDK, 2018-2022c).

### 3.6. Coal Usage

In Figure 6 usage of coal and kerosene in Konya during the last 5 years is given. In Konya province, the amount of coal usage in residences and industries (domestic + imported) has decreased by 42.7% in the last 5 years.

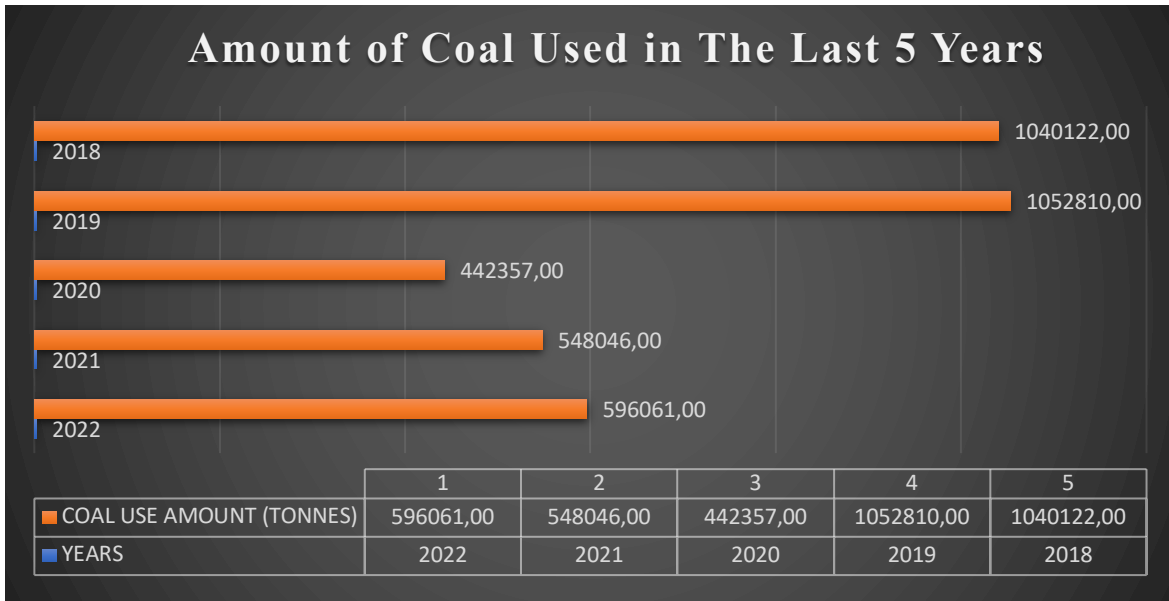

**Figure 6.** Schematic Representation of Coal Usage by Years (TUİK, 2023; EPDK, 2018-2022a; EPDK, 2018-2022b, EPDK, 2018-2022c).

#### 4. RESULTS AND DISCUSSION

LPG , fuel oil are among the non-renewable energy sources that play a major role in air pollution in Konya province. Oil , kerosene and coal usage amounts were examined on the basis of the last 5 years. In Table 1 summary of the utilization of non-renewable energy sources in the last 5 years. The new investments made by natural gas distribution companies, especially the new industrial zones built in Konya in the last 5 years, the new routes they opened, the number of new subscribers gained and the increasing annual production tonnage in the industry, have caused the amount of natural gas to increase by 50% compared to 5 years ago. When we look at the changes in the amount of diesel, it is seen that since the agricultural sector uses diesel mainly both locally and on a country basis, farmers have had difficulty in allocating diesel, considering the economic conditions over the years, and there is not much of an increase in diesel, and even a decrease in its use from time to time. When we look at other non-renewable energy sources, we see that there has been a one-third increase in gasoline in the last 5 years. When we look at the upward momentum in the population and vehicle market, we see that this increase is associated with the increase in gasoline prices. Fuel fuel has the highest percentage increase but its usage is at more reasonable levels compared to other sources. Oil, on the other hand, is preferred both in industrial facilities and in residences because it is more cost-effective compared to natural gas, and has increased by 64% in the last 5 years. Finally, when the data of coal use in Konya province in the last 5 years is examined, it is seen that there is a decrease of 42.7 %. The reasons for this decrease are Local Environmental Board's decision to ban the use of coal in industrial facilities in the center of Konya, and in the last 2 years, under the leadership of the Ministry of Environment, Urbanization and Climate Change and the Konya Metropolitan Municipality Climate Change and Zero Waste Department, the houses in the lower socioeconomic levels, which received coal aid under the name of clean transformation, were given to the houses in lower socioeconomic levels. It appears that the natural gas installation is being installed. The main reason for the decrease in coal use, especially in the central region of Konya, is directly due to these two reasons.

Proceeding Book of ISESER 2023

**Table 1.** Utilization of Non-Renewable Energy Sources in the Last 5 Years (TUİK, 2023; EPDK, 2018-2022a; EPDK, 2018-2022b, EPDK, 2018-2022c).

YEARS	AMOUNT OF NATURAL GAS USED	AMOUNT OF GASOLINE USED
2022	1094442514 M3	66465 TON
2021	1005436341 M3	64263,7 TON
2020	910472941,4 M3	49397,67 TON
2019	855363550,6 M3	50910,61 TON
2018	766118107 M3	49383,55 TON
	AMOUNT OF DIESEL USED	AMOUNT OF FUEL OİL USED
2022	831319,00	5224 TON
2021	845612,00	2674 TON
2020	711522,00	7209 TON
2019	732985,00	12108 TON
2018	869020,00	3180 TON
	AMOUNT OF KEROSENE USED	AMOUNT OF LPG USED
2022	257,00	144638,687 M3
2021	204,00	151150,064 M3
2020	258,00	144955 M3
2019	464,00	159174,776 M3
2018	490,00	159676 M3
	AMOUNT OF COAL USED	
2022	596061	
2021	548046	
2020	442357	
2019	1052810	
2018	1040122	

## 5. CONCLUSIONS

In this study, the changes in the non-renewable energy resources used in Konya province in the last 5 years was examined. When the necessary studies and regulations are made, the usage of non-renewable energy sources can be reduced and the air quality can be contributed to the improvement. There are still fossil resources that their usage is increasing. If we want to improve air quality and limit the greenhouse gas emissions that accompany with pollutants, which are becoming a bigger problem day by day, we need to focus heavily on renewable energy sources.

## REFERENCES

- EPDK, (2018-2022a). Doğalgaz Piyasası Yıllık Sektör Raporu, <https://www.epdk.gov.tr/Detay/Icerik/3-0-94/dogal-gazyillik-sektor-raporu> (Accessed date: 13.08.2023)
- EPDK. (2018-2022b). LPG Piyasası Yıllık Sektör Raporu. <https://www.epdk.gov.tr/Detay/Icerik/3-0-108-1002/lpgyillik-sektor-raporlari> (Accessed date: 13.08.2023)
- EPDK. (2018-2022c). Petrol Piyasası Yıllık Sektör Raporu. <https://www.epdk.gov.tr/detay/icerik/3-0-107/yillik-sektor-raporu> (Accessed date: 13.08.2023)
- ÇŞİDB, (2018). Konya Çevre Durum Raporu. [https://webdosya.csb.gov.tr/db/ced/icerikler/konya\\_cdr\\_2018\\_rev-ze-20190808113124.pdf](https://webdosya.csb.gov.tr/db/ced/icerikler/konya_cdr_2018_rev-ze-20190808113124.pdf) (Accessed date: 15.08.2023)
- ÇŞİDB, (2019). Konya Çevre Durum Raporu. [https://webdosya.csb.gov.tr/db/ced/icerikler/2019\\_cdr\\_konya-20200722143120.pdf](https://webdosya.csb.gov.tr/db/ced/icerikler/2019_cdr_konya-20200722143120.pdf) (Accessed date: 12.08.2023)
- ÇŞİDB, (2020). Konya Çevre Durum Raporu. [https://webdosya.csb.gov.tr/db/ced/icerikler/2020\\_konya\\_cdr-20210623132858.pdf](https://webdosya.csb.gov.tr/db/ced/icerikler/2020_konya_cdr-20210623132858.pdf) (Accessed date: 12.08.2023)
- ÇŞİDB, (2021). Konya Çevre Durum Raporu. <https://webdosya.csb.gov.tr/db/ced/icerikler/konya-ilcdr-2021-20220811104238.pdf> (Accessed date: 12.08.2023)
- ÇŞİDB, (2022). Konya Çevre Durum Raporu. <https://webdosya.csb.gov.tr/db/ced/icerikler/konya-ilcdr-2022-20230823154609.pdf> (Accessed date: 12.08.2023)

**Proceeding Book of ISESER 2023**

KTO (Konya Ticaret Odası), (2022). Ekonomi Raporu. <https://www.kto.org.tr/haberler/konya-ekonomi-raporu-2022> (Accessed date: 10.08.2023)

TÜİK, (2018-2022). From <https://data.tuik.gov.tr/Kategori/GetKategori?p=Cevre-ve-Enerji-103> (Accessed date: 15.08.2023)

Konya Valiliği, Konya Büyükşehir Belediyesi, (2013-2019). Konya Temiz Hava Eylem Planı. <https://webdosya.csb.gov.tr/db/konya/icerikbelge/icerikbelge1500.pdf> (Accessed date: 10.08.2023)



**O 15. IMPORTANCE OF TRICLOSAN FOR ENVIRONMENT AND HUMAN HEALTH**

Oğuzhan GÖK<sup>1\*</sup>, Burak TEKELIOGLU<sup>1</sup>

<sup>1</sup>*Aksaray University, Department of Environmental Engineering, Aksaray, Türkiye*

E-mail: *oguzgok@gmail.com; burak\_tekelioglu42@hotmail.com*

**ABSTRACT:** Triclosan (TCS) is the active ingredient used in health and personal care products, especially in the structure of toothpastes, due to its antibacterial properties, and its concentrations are mainly 0.1-0.3% by weight. The use of antimicrobial and antibacterial products is increasing steadily around the world, so there is a constant release of TCS compound into the environment. Recent studies show that the use of antibacterial products is increasing during the corona virus pandemic process, so it is observed that TCS has increased in contact with humans and the environment. TCS is a chemical substance that has the potential for toxic biocide degradation in the environment and may adversely affect the environment and human health. This compound is known as “endocrine disrupting chemicals (EDC)” because it accumulates in aquatic organisms and remains intact in the environmental environment for a long time and is included in a group generally defined as "Emerging Organic Pollutants (EOP)". In this study, the properties of TCS, its contact with the human body and face water, its treatment in the wastewater treatment plant and its effects on the environment and human life are mentioned.

*Keywords: Triclosan, Environment, Health, Toxicology*

**1. INTRODUCTION**

Triclosan (TCS: C<sub>12</sub>H<sub>17</sub>Cl<sub>3</sub>O<sub>2</sub>; 2,4,4'-trichloro-2'-hydroxydiphenyl ether) is the most common active antiseptic ingredient used in soap. It is used in cosmetics, including soap, toothpaste, lotion and shampoos, and to prevent bacterial contamination in other products such as textiles, kitchenware, furniture, toys. TCS is a phenoxyphenol antimicrobial agent first developed in the early 1960s and has been used as an antibacterial since the 1970s (Kim et al., 2015).

The negative opinions derived from studies with animal models show that TCS is a toxic chemical that has the potential to affect human health. This biocide has been shown to bioaccumulate in aquatic species. TCS has been observed to persist for long periods in the environment, especially under anaerobic conditions. This compound belongs to a group of many known as endocrine disrupting chemicals (EDCs), often described as "Emerging Organic Pollutants" (Chalew and Halden, 2009).

Once in the aquatic environment, TCS undergoes a series of conversion reactions in some cases to decompose into more toxic or bioaccumulative compounds. Sodium hypochlorite (bleach) in tap water or discharged into wastewater sewers by household disinfection products causes oxidation of TCS. This reaction leads to the formation of the relatively unstable tetra and pentachloric diphenyl ethers, which then decompose into dichloro and trichlorophenols (Morales et al., 2005).

It has been shown that when chemical-containing PCPs (Personal Care Production) are used, chemicals enter the human body through percutaneous absorption. It has been reported that TCS enters the human body primarily through oral intake and dermal contact with PCPs. It has been observed that 9% of the applied TCS is biologically penetrated into the human body after 24 hours of dermal exposure (Lu et al., 2018). TCS can be released into the environment as a result of various stages. TCS can be discharged directly into the aquatic environment after wastewater treatment plant treatment. TCS can be adsorbed on organic particles in sewage sludge during wastewater treatment with a high log K<sub>ow</sub> of 4.76 and is likely to then be transported to soil via sludge application (Guo and Iwata, 2017).

TCS, which draws attention around the world, has been restricted to its concentrations in the product in many countries. TCS concentration is limited to 0.3% in all cosmetic products in Europe (Heisterberg and Menné, 2003), Canada (Government of Canada, 2019), South Africa (Lehutso et al., 2017) and Australia (EPA, 2016), and 0.1% in Japan (EPA, 2016).

**Proceeding Book of ISESER 2023**

**1.1. TCS Chemical**

An estimated 1500 tons of TCS are produced annually worldwide, of which about 350 tons are produced in Europe (Bester, 2005). TCS is an antimicrobial that has been found in a variety of consumer products since its first use in hospital settings in 1972, including soaps, hand sanitizers, toothpastes and mouthwashes. In 1977, TCS production was between 0.5 and 1 million pounds per year. This production increased from 1 to 10 million pounds in 1998. Between 1999 and 2000, 75% of 178 liquid soaps contained TCS and 30% of more than 300 bar soap samples contained TCS. In the late 2000s (2008–2010), TCS was found as an active ingredient in 93% of liquid, gel or foam soaps (Weatherly and Gosse, 2017). Kim et al., (2015), in their study, found that approximately 76% of liquid hand soaps and 29% of bar soaps contained TCS in 2015.

**Table 1.** Products Containing the Chemical TCS

Category	Product	Reference
Personal care products	Soaps, detergents, shaving gels, face washes, wet wipes, skin cleansers, toothpastes, mouthwashes, cosmetics, deodorants	(Weatherly and Gosse, 2017)
Household products	Kitchenware, dishwashing liquid, toys, computer equipment, furniture, humidifiers, helmets, wall coverings, air filters, blankets, mats, handrails, paints, earplugs, coolers, drinkers, feeders, vacuum food containers	(Dhillon et al., 2015)
Textile	Clothes, shoes, sandals, towels	(Zhao et al., 2016)
First aid	Antiseptics, Burn creams, Medicated sprays	(Dhillon et al., 2015)
Office and school products	Calculators, scissors, paper, glue, cutting tools, notebooks, pens	(Dhillon et al., 2015)

**2. TCS IN THE AQUATIC ENVIRONMENT**

TCS, which is included in personal care and health products and has antibacterial properties, penetrates into the aquatic environment through sewage after consumption and poses a potential threat to existing organisms in the water or to the environment. In many studies and researches, varying concentrations of TCS have been detected in surface or underground waters in various parts of the world.

Surface waters with high concentrations of TCS in China are generally found in or near urban areas. The TCS concentration in Liao River was 27.4 ng/l, 6.89 ng/l for Hai River, 8.7 ng/l for Yellow River, 95.7 ng/l for Zhujiang River and finally 26.4 ng/l for Dongjiang River (Zhao et al., 2013). TCS an endocrine disrupting phenol, was found to be highly present in river water in China, with a TCS concentration of 35 – 1023 ng/l. The cause of the TCS concentration in river water is thought to be mainly due to random discharge or seepage of municipal wastewater (Peng et al., 2008).

The presence of chemical substances in surface waters is important for humans and the environment. Because surface waters have been the main source of drinking water for people from past to present and are home to many living things. Drinking water is the primary source of dietary intake of the pollutant. For this, the control of chemicals or pollutants in surface waters is an important issue. TCS concentrations of 2.6 ng/l and 8 ng/l were found in the lake waters of Mead and Las Vegas Wash in the USA. TCS is thought to be adversely affected by Las Vegas Wash as the lake water is a habitat for various wild animals, including birds and fish. It is also thought that the concentration detected in Lake Mead may have long-lasting effects on human health because Lake Mead is the primary source of drinking water for local residents (Bai and Acharya, 2017).

In another study conducted in the North American continent, TCS was determined in the Mississippi river in New Orleans, Louisiana, USA. TCS was detected in the range of 8.8 to 34.9 ng/l in the river water in the determination (Zhang, Zhang, Darisaw, Ehie and Wang 2007). It is estimated that TCS passes into ground waters with the leakage of surface waters. TCS concentrations in groundwater have been found to be 12-53 ng/l in the USA (Karnjanapiboonwong, 2011). This study demonstrates the presence of endocrine disrupting chemicals even in groundwater.

**Table 2.** TCS Concentration in the Aquatic Environment on Earth

<b>Sample Region</b>	<b>Location</b>	<b>TCS Concentration</b>	<b>Reference</b>
River water	China	0,035-1.023 µg/l	Peng et al., 2008
River water	India	5.14 ng/l	Ramaswamy et al., 2011
River water	USA	8.8-34.9 ng/l	Zhang et al., 2007
Lake water	USA	0,0026-0,008 µg/l	Bai and Acharya, 2017
Canal water	Japan	0,011-0,031 µg/l	Nishi et al., 2008
Tap water	Taiwan	14 ng/l	Li et al., 2010
Drinking water	Taiwan	8 ng/l	Li et al., 2010
Drinking water	USA	1.4 ng/l	Padhye et al., 2014

When we look ahead, the demand for water increases with the increasing population and the current water scarcity emerges. Studies are needed to increase water resources, recycle and reuse water. Recently, due to the developing technology and changing needs, the use of chemicals has increased, and it has become easier for the increased chemicals to enter the water environment with discharge. As a result of discharges, water, soil and nature are directly polluted. Therefore, the treatment and control of wastewater becomes important. To obtain a reliable estimate of TCS removal in sewage treatment plants (WWTP), the concentration of the main pollutant and its conversion products must be determined in both the water phase and the solid sludge.

TCS which comes to the wastewater treatment plant, goes through the primary treatment after entering the wastewater treatment plant, but the efficiency of this treatment method remains low compared to the secondary, that is, biological treatment. Removal of pharmaceuticals and personal care products (PPCDs) in physical and chemical treatment processes is limited (28%), but it has been observed that the majority of PPCDs are removed in secondary treatment (biological processes) (Behera et al., 2011).

It has been stated that a significant portion of water pollutants are pharmaceuticals and personal care products. In the research of pharmaceuticals and personal care products in the inlet water of the wastewater treatment plant that treats urban wastewater, the treatment efficiency was found to be 74.5%. It has been observed that ozonation after biological treatment is effective in the purification of TCS (Rosal et al., 2010). It has been observed that anaerobic treatment, one of the wastewater treatment processes, is more efficient than the aerobic process to treat TCS in the water in the system. From this point of view, it is understood that TCS chemical decomposes in an oxygen-free environment and some of it is separated from the aquatic environment. In the study, it was understood that the treatment sludge absorbs TCS (Best, 2003).

### **3. EFFECTS OF TCS EXPOSURE ON HUMAN HEALTH**

With the increasing consumption of TCS recently, it has become easier to contact environmental factors, and as a result, people's lives are also affected. Guo and Iwata (2017) stated in their study that consumption of TCS contaminated fish in drinking water or food chain are two different ways for humans to be exposed to TCS. The absorption of TCS into the human body after dermal application of a hydrophobic cream containing 2% TCS to humans was studied. They calculated that after 12 hours of exposure, TCS is absorbed into the human body and most of it is excreted through the urine within 24 hours, and the half-life of TCS in the human body is 10.8 hours (Queckenberg et al., 2010).

TCS is included as an antibacterial agent in many toothpastes sold worldwide. Individuals are chronically exposed to chemicals once or twice a day along with tooth brushing. TCS reaches the systemic circulation by absorption through the mucous membranes of the oral cavity and gastrointestinal tract, thereby initiating a systemic exposure. The antibacterial properties of TCS have been shown to be exerted by inhibition of an enoyl-reductase involved in fatty acid synthesis in bacteria. The lipophilic properties of TCS also increase its dermal absorption and percutaneous penetration of TCS is quite high

**Proceeding Book of ISESER 2023**

(Sandborgh-Englund et al., 2006). TCS, which penetrates the skin and enters the human body, is known to accumulate mainly in the liver. In the TCS study on adipose tissue (adipose tissue), liver and brain samples from human cadavers, concentrations were detected in almost all livers (10/11), most adipose tissue (7/11) and only one brain sample. Total TCS concentrations were 3.92 ng/g in adipose tissue, 0.23 ng/g in brain and 29.03 ng/g in liver. He found that the human liver was the organ with the highest concentration of TCS (Geens et al., 2012). In another study that mothers were divided into those who use TCS-containing personal care products and those who use products that do not contain TCS that TCS has been found in a wide range of concentrations in both mothers using and not using TCS-containing products. TCS has been found in a wide range of concentrations in both mothers using and not using TCS-containing products. TCS has been detected at levels of 20-300 ng/g in breast milk and in the range of 0.01-38 ng/ml in plasma samples. Breastfed infants (daily TCS intake 11-570 ng/day) have been observed to be exposed to very low doses of TCS through breast milk (Allmyr et al., 2006).

In a study conducted on urine, nail and toenail samples of healthy volunteers aged 19-32 years living in Beijing and Sichuan provinces of China, TCS was detected in 80% of urine samples, 79% of fingernails and 69% of toenail samples. Mean concentrations of TCS were 0.36 µg/L in urine, 5.67 µg/kg in fingernails and 13.57 µg/kg in toenails (Yin et al., 2016). In another study, TCS analysis was performed from male and female urine samples collected from seven Asian countries, Greece and the USA; Urine TCS concentration in China 2.38 µg/l, India 4.64 µg/l, Korea 0.7 µg/l, Kuwait 2.5 µg/l, Japan 0.9 µg/l, Saudi Arabia 0.44 µg/l, Vietnam 0.42 µg/l, Greece 1.94 µg/l and finally USA 7.84 µg/l (Iyer et al., 2018).

**4. ENVIRONMENTAL HEALTH EFFECTS OF TCS EXPOSURE**

Surface water, which is the final destination of many wastewater, is one of the environmental elements most affected by chemicals. Studies show that living creatures living in the aquatic environment are affected by chemicals and accumulate in their bodies. The fact that fish are in an important position in the food chain increases the importance of knowing the chemical concentrations in the aquatic environment for future studies (Zhao et al., 2013).

It has been shown that the antibacterial effects of TCS are mediated, at least in part, through its membranotropic effects, leading to unstable structures that compromise the functional integrity of cell membranes without inducing cell lysis. TCS interferes with the stabilization and integrity of the sperm membrane, which may be the possible cause of sperm death (Villalain et al., 2001). Sea urchin (*Strongylocentrotus nudus*) exposed to TCS Fertilization rate was affected at 0.5 µM TCS and no fertilization occurred at concentrations higher than 1.25 µM TCS. It was observed that fertilization occurred in 97.4±1.21%, 92.9±1.8%, and 82.7±1.57%, respectively, when exposed to 0.1, 0.5, and 1.0 µM TCS. The EC<sub>50</sub> value of the TCS concentration was determined as 1.49 µM (Hwang et al., 2014).

LC<sub>50</sub> values of TCS on medaka *Oryzias latipes* were determined at 96 hours, 602 µg/l for 24-hour larvae and 399 µg/l for embryos. Embryonic development, hatchability, and hatching time of medaka eggs were affected by TCS exposure. The hatchability of fertilized eggs exposed to TCS was significantly reduced in the treatment groups compared to controls at concentrations above 313 µg/l, and the hatching time was also significantly delayed (Ishibashi et al., 2004). In adult zebrafish exposed to TCS, it was determined that the total distance traveled and movement speed decreased as the concentration increased, and an increase in freezing and suspending behaviors was observed (Pullaguri et al., 2020). In the study, adult mice were chronically exposed to TCS. It was determined that body weights were affected and memory formation was impaired in female mice affected by the TCS compound, while male mice caused a decrease in social interaction. (Hao et al., 2022)

**Table 3.** Effect on Reproduction, Hatching, Behavioral and Physical Development of Aquatic Organisms Exposed to TCS

Organism	Scientific name	TCS concentration	Major Results	Reference
Frog	<i>Peleophylax perezi</i>	0.25–2.5 mg/l; 72 s	70% decrease in hatching rate after 72 hours.	(Martins et al., 2017)

**Proceeding Book of ISESER 2023**

Mosquito fish	Mosquitofish	100–350 nM;35 g	Decrease in sperm count.	(Raut et al., 2010)
Zebra Fish	Danio rerio	0.1–0.9 mg/l;24–144 s	Irregular swimming and loss of balance at high TCS concentrations.	(Oliveira et al., 2010)
Zebra Fish	Danio rerio	0.4-40 µg/l; 5 g	Foraging and foraging efficiency decreased with increasing concentration.	(Wirt et al., 2018)
Zebra Fish	Danio rerio	0.2-0.8 mg/l	Prolonged incubation time and decreased heart rate.	(Kim et al., 2008)

**5. DISCUSSION**

The main exposure of TCS to the environment is due to the discharge of wastewater from people's personal care products after use or from the wastewater of factories producing TCS. Studies show that the presence of TCS in many surface waters around the world is an important component that has a worldwide impact on human and environmental health. TCS, which can penetrate the aquatic environment, also threatens the health of living things in the aquatic ecosystem. It was observed that zebrafish exposed to TCS chemical had behavioral changes as the concentration increased (Pullaguri et al., 2020).

In the study conducted by Allmyr et al. (2006), chemical concentrations were found in the blood of people who declared that they did not use TCS-containing products. It is proof that we are unwittingly in contact with endocrine disrupting chemicals. TCS concentrations were detected in the plasma of the babies in the examination, and it is thought that the reason for this is that the mother's milk is contaminated with the chemical and passed to the baby. TCS is mainly found in many disinfectant products as antibacterial (Weatherly and Gosse, 2017). It was reported that the use of hand sanitizer increased from 14.6% before COVID 19 to 89.8% after COVID 19, and the number of consumers carrying hand disinfectants increased from 4.1% before COVID 19 to 39.3% after COVID 19 (Choi et al., 2021).

Studies show that all individuals, from infants to the elderly, are exposed to TCS. Recently, the amount of hand disinfectants or soaps containing TCS that people use for defense against viruses has been increasing. With this increase, TCS production increases and the waste water generated as a result of use directly affects environmental health. In the research conducted in urban wastewater treatment, it was found that the treatment efficiency of TCS in personal care and disinfectant products was 74.5%, which shows that the treatment of TCS in the water environment is insufficient (Rosal et al., 2010). These studies show that the production of TCS, which is used as an antibacterial, is increasing day by day. At the end of the consumption of cosmetic or antibacterial products, the compound that comes to the treatment plant is released into the environment because it is not purified at full efficiency. TCS reaching the aquatic environment affects aquatic organisms and contaminates them. The water or fish consumed by people pose a threat to human health. To protect against the chemical TCS concentration restrictions should be imposed on products or they should be banned. It is important to research the chemical TCS for the future of human and natural life.

**REFERENCES**

- Allmyr, M., Adolfsson-Erici, M., McLachlan, M. S. and Sandborgh-Englund, G. (2006). Triclosan in plasma and milk from Swedish nursing mothers and their exposure via personal care products. *Science of the Total Environment*, 372(1), 87-93.
- Bai, X. and Acharya, K. (2017). Algae-mediated removal of selected pharmaceutical and personal care products (PPCPs) from Lake Mead water. *Science of the Total Environment*, 581, 734-740.

**Proceeding Book of ISESER 2023**

- Behera, S. K., Kim, H. W., Oh, J. E. and Park, H. S. (2011). Occurrence and removal of antibiotics, hormones and several other pharmaceuticals in wastewater treatment plants of the largest industrial city of Korea. *Science of the total environment*, 409(20), 4351-4360.
- Bester, K. (2003). Triclosan in a sewage treatment process—balances and monitoring data. *Water research*, 37(16), 3891-3896.
- Bester, K. (2005). Fate of triclosan and triclosan-methyl in sewage treatment plants and surface waters. *Archives of Environmental Contamination and Toxicology*, 49, 9-17.
- Chalew, T. E. and Halden, R. U. (2009). Environmental exposure of aquatic and terrestrial biota to triclosan and triclocarban 1. *JAWRA Journal of the American Water Resources Association*, 45(1), 4-13.
- Choi, K., Sim, S., Choi, J., Park, C., Uhm, Y., Lim, E., Kim, A. Y., Yoo, S. J. and Lee, Y. (2021). Changes in handwashing and hygiene product usage patterns in Korea before and after the outbreak of COVID-19. *Environmental Sciences Europe*, 33(1), 1-10.
- Dar, O. I., Aslam, R., Pan, D., Sharma, S., Andotra, M., Kaur, A., Jia, A. Q. and Faggio, C. (2022). Source, bioaccumulation, degradability and toxicity of triclosan in aquatic environments: A review. *Environmental Technology & Innovation*, 25, 102122.
- Dhillon, G. S., Kaur, S., Pulicharla, R., Brar, S. K., Cledón, M., Verma, M. and Surampalli, R. Y. (2015). Triclosan: current status, occurrence, environmental risks and bioaccumulation potential. *International journal of environmental research and public health*, 12(5), 5657-5684.
- EPA (2016, December 23). *Triclosan Fact Sheet*. <https://www.epa.gov/assets/uploads/documents/everyday-environment/publications/triclosan-fact-sheet-dec16.pdf>
- Geens, T., Neels, H. and Covaci, A. (2012). Distribution of bisphenol-A, triclosan and n-nonylphenol in human adipose tissue, liver and brain. *Chemosphere*, 87(7), 796-802.
- Government of Canada (2019, August 23). *Triclosan*. <https://www.canada.ca/en/health-canada/services/chemicals-product-safety/triclosan.html>
- Guo, J. and Iwata, H. (2017). Risk assessment of triclosan in the global environment using a probabilistic approach. *Ecotoxicology and Environmental Safety*, 143, 111-119.
- Hao, Y., Meng, L., Zhang, Y., Chen, A., Zhao, Y., Lian, K., Guo, X., Wang, X., Du, Y., Wang, X., Li, X., Song, L., Shi, Y., Yin, X., Gong, M., and Shi, H. (2022). Effects of chronic triclosan exposure on social behaviors in adult mice. *Journal of Hazardous Materials*, 424, 127562.
- Heisterberg, M. V. and Menné, T. (2003). Council Directive 76/768/EEC of 27 July 1976 on the approximation of the laws of the member states relating to cosmetic products. *Official Journal of the European Union*, 262(9), 169-200.
- Hwang, J., Suh, S. S., Park, S. Y., Ryu, T. K., Lee, S. and Lee, T. K. (2014). Effects of triclosan on reproductive parameters and embryonic development of sea urchin, *Strongylocentrotus nudus*. *Ecotoxicology and Environmental Safety*, 100, 148-152.
- Ishibashi, H., Matsumura, N., Hirano, M., Matsuoka, M., Shiratsuchi, H., Ishibashi, Y. and Arizono, K. (2004). Effects of triclosan on the early life stages and reproduction of medaka *Oryzias latipes* and induction of hepatic vitellogenin. *Aquatic toxicology*, 67(2), 167-179.
- Iyer, A. P., Xue, J., Honda, M., Robinson, M., Kumosani, T. A., Abulnaja, K. and Kannan, K. (2018). Urinary levels of triclosan and triclocarban in several Asian countries, Greece and the USA: Association with oxidative stress. *Environmental research*, 160, 91-96.
- Karnjanapiboonwong, A., Suski, J. G., Shah, A. A., Cai, Q., Morse, A. N. and Anderson, T. A. (2011). Occurrence of PPCPs at a wastewater treatment plant and in soil and groundwater at a land application site. *Water, Air, & Soil Pollution*, 216(1), 257-273.
- Kim, J., Oh, H., Ryu, B., Kim, U., Lee, J. M., Jung, C. R., Kim, C. Y. and Park, J. H. (2018). Triclosan affects axon formation in the neural development stages of zebrafish embryos (*Danio rerio*). *Environmental Pollution*, 236, 304-312.
- Kim, S. A., Moon, H., Lee, K., and Rhee, M. S. (2015). Bactericidal effects of triclosan in soap both in vitro and in vivo. *Journal of Antimicrobial Chemotherapy*, 70(12), 3345-3352.
- Lehutso, R. F., Daso, A. P. and Okonkwo, J. O. (2017). Occurrence and environmental levels of triclosan and triclocarban in selected wastewater treatment plants in Gauteng Province, South Africa. *Emerging Contaminants*, 3(3), 107-114.

**Proceeding Book of ISESER 2023**

- Li, X., Ying, G. G., Su, H. C., Yang, X. B. and Wang, L. (2010). Simultaneous determination and assessment of 4-nonylphenol, bisphenol A and triclosan in tap water, bottled water and baby bottles. *Environment international*, 36(6), 557-562.
- Lu, S., Yu, Y., Ren, L., Zhang, X., Liu, G. and Yu, Y. (2018). Estimation of intake and uptake of bisphenols and triclosan from personal care products by dermal contact. *Science of the Total Environment*, 621, 1389-1396.
- Martins, D., Monteiro, M. S., Soares, A. M. and Quintaneiro, C. (2017). Effects of 4-MBC and triclosan in embryos of the frog *Pelophylax perezi*. *Chemosphere*, 178, 325-332.
- Morales, S., Canosa, P., Rodríguez, I., Rubí, E. and Cela, R. (2005). Microwave assisted extraction followed by gas chromatography with tandem mass spectrometry for the determination of triclosan and two related chlorophenols in sludge and sediments. *Journal of Chromatography A*, 1082(2), 128-135.
- Nishi, I., Kawakami, T. and Onodera, S. (2008). Monitoring of triclosan in the surface water of the Tone Canal, Japan. *Bulletin of environmental contamination and toxicology*, 80(2), 163-166.
- Oliveira, R., Domingues, I., Koppe Grisolia, C. and Soares, A. M. (2009). Effects of triclosan on zebrafish early-life stages and adults. *Environmental Science and Pollution Research*, 16, 679-688.
- Padhye, L. P., Yao, H., Kung'u, F. T. and Huang, C. H. (2014). Year-long evaluation on the occurrence and fate of pharmaceuticals, personal care products, and endocrine disrupting chemicals in an urban drinking water treatment plant. *Water research*, 51, 266-276.
- Peng, X., Yu, Y., Tang, C., Tan, J., Huang, Q. and Wang, Z. (2008). Occurrence of steroid estrogens, endocrine-disrupting phenols, and acid pharmaceutical residues in urban riverine water of the Pearl River Delta, South China. *Science of the total environment*, 397(1-3), 158-166.
- Pullaguri, N., Nema, S., Bhargava, Y. and Bhargava, A. (2020). Triclosan alters adult zebrafish behavior and targets acetylcholinesterase activity and expression. *Environmental Toxicology and Pharmacology*, 75, 103311.
- Pullaguri, N., Nema, S., Bhargava, Y. and Bhargava, A. (2020). Triclosan alters adult zebrafish behavior and targets acetylcholinesterase activity and expression. *Environmental Toxicology and Pharmacology*, 75, 103311.
- Queckenberg, C., Meins, J., Wachall, B., Doroshenko, O., Tomalik-Scharte, D., Bastian, B., Tawab, M. A. and Fuhr, U. (2010). Absorption, pharmacokinetics, and safety of triclosan after dermal administration. *Antimicrobial agents and chemotherapy*, 54(1), 570-572.
- Ramaswamy, B. R., Shanmugam, G., Velu, G., Rengarajan, B. and Larsson, D. J. (2011). GC-MS analysis and ecotoxicological risk assessment of triclosan, carbamazepine and parabens in Indian rivers. *Journal of hazardous materials*, 186(2-3), 1586-1593.
- Raut, S. A. and Angus, R. A. (2010). Triclosan has endocrine-disrupting effects in male western mosquitofish, *Gambusia affinis*. *Environmental Toxicology and Chemistry*, 29(6), 1287-1291.
- Rosal, R., Rodríguez, A., Perdígón-Melón, J. A., Petre, A., García-Calvo, E., Gómez, M. J., Agüere, A. and Fernández-Alba, A. R. (2010). Occurrence of emerging pollutants in urban wastewater and their removal through biological treatment followed by ozonation. *Water research*, 44(2), 578-588.
- Sandborgh-Englund, G., Adolfsson-Erici, M., Odham, G. and Ekstrand, J. (2006). Pharmacokinetics of triclosan following oral ingestion in humans. *Journal of Toxicology and Environmental Health, Part A*, 69(20), 1861-1873.
- Villalaín, J., Mateo, C. R., Aranda, F. J., Shapiro, S. and Micol, V. (2001). Membranotropic effects of the antibacterial agent triclosan. *Archives of biochemistry and biophysics*, 390(1), 128-136.
- Weatherly, L. M. and Gosse, J. A. (2017). Triclosan exposure, transformation, and human health effects. *Journal of Toxicology and Environmental Health, Part B*, 20(8), 447-469.
- Wirt, H., Botka, R., Perez, K. E. and King-Heiden, T. (2018). Embryonic exposure to environmentally relevant concentrations of triclosan impairs foraging efficiency in zebrafish larvae. *Environmental toxicology and chemistry*, 37(12), 3124-3133.
- Yin, J., Wei, L., Shi, Y., Zhang, J., Wu, Q. and Shao, B. (2016). Chinese population exposure to triclosan and triclocarban as measured via human urine and nails. *Environmental geochemistry and health*, 38(5), 1125-1135.
- Zhang, S., Zhang, Q., Darisaw, S., Ehie, O. and Wang, G. (2007). Simultaneous quantification of polycyclic aromatic hydrocarbons (PAHs), polychlorinated biphenyls (PCBs), and pharmaceuticals

**Proceeding Book of ISESER 2023**

- and personal care products (PPCPs) in Mississippi river water, in New Orleans, Louisiana, USA. *Chemosphere*, 66(6), 1057-1069.
- Zhao, C., Xie, H., Xu, J., Zhang, J., Liang, S., Hao, J., Ngo, A. H., Guo, W., Xu, X., Wang, Q and Wang, J. (2016). Removal mechanisms and plant species selection by bioaccumulative factors in surface flow constructed wetlands (CWs): In the case of triclosan. *Science of the Total Environment*, 547, 9-16.
- Zhao, J. L., Zhang, Q. Q., Chen, F., Wang, L., Ying, G. G., Liu, Y. S., Yng, B., Zhou, L. J., Liu, S., Su, H. C. and Zhang, R. Q. (2013). Evaluation of triclosan and triclocarban at river basin scale using monitoring and modeling tools: implications for controlling of urban domestic sewage discharge. *Water research*, 47(1), 395-405.



**O 16. MICROBIAL CENOSIS DEVELOPMENT IN THE SOIL OF CULTIVATED CROPS**

Iryna GUMENIUK<sup>1\*</sup>, Levishko ALLA<sup>1</sup>, Tsvigun VIKTORIYA<sup>1</sup>

*<sup>1</sup>Institute of Agroecology and Environmental Management of NAAS of Ukraine, Kyiv, Ukraine*

E-mail: *gumenyuk.ir@gmail.com*

**ABSTRACT:** Soil is a dynamic, living, and integral part of the land ecosystem. Depending on the presence of plant growth on it, it can be divided into two types, namely rhizosphere and non-rhizosphere soil. We have conducted a study aimed at identifying the differences between rhizosphere and bulk soil in the cultivation of some cultivated plants under organic farming conditions. Soil samples for the study were taken from a depth of 0-20 cm, before sowing cultivated crops (soybeans, wheat, corn, sunflower, buckwheat) and 45 days after germination. The number of microorganisms was counted by the generally accepted method of tenfold dilutions with sowing them on appropriate nutrient media. We have found that the number of microorganisms of the main taxonomic groups (micromycetes, non-spore bacteria, actinomycetes, cellulolytic bacteria) after 45 days of cultivation of the above-mentioned plants did not change significantly in bulk soil, in contrast to rhizosphere soil. The results of this study showed that the rhizosphere soil of different cultivated plants is colonized by different species and populations of microorganisms compared to non-rhizosphere (bulk) soil. The cultivation of cultivated plants can positively affect the processes of humus formation, and the permanent cultivation of any crop significantly disrupts the stability of the microbial of the rhizosphere compared to the use of crop rotation.

*Keywords: Rhizosphere Soil, Bulk Soil, Groups of Microorganisms, Cultivated Crops*

**O 17. DICHOTOMY ISSUES IN ENVIRONMENTAL ETHICS – A CRITICAL ANALYSIS OF  
ECO-ANTHROPOHOLISM**

Esra Samuel Akpan BASSEY<sup>1</sup>

<sup>1</sup>*Unuversity of Calabar, Nigeria.*

E-mail: *esra samuelbassey15@yahoo.com(s)*

**ABSTRACT:** Ankara Many want to acquire a home and live happily. In the face of global shortages, hostility, and natural catastrophes, humans, like other species and other lesser beings, want a better environment to be happy and peaceful. The existential commitment is to understand human place among nature until the question of human "position" in the world emerges. The first human worldview—anthropocentric nature and attitude—has been a major environmental ethical concern since the subject matter of environmental ethics The anthropocentric view places people at the core of the universe. Thus, humans, in Protagoras words', are the measure of all things. Alternatively, recent ecological studies are based on holism, which holds that understanding a portion depends on its relationship to the whole. This perspective views every creature as an integral part of a complex, linked organism, where each component is interdependent due to its role in life. Furthermore, according to the holistic worldview, humans are intrinsically tied to the natural environment and should be seen as an integral part of the ecological system. A new twist is the fact that many supporters of weak anthropocentrism claim that it is not totally dismissible since "obligation" and morality are human-centered. This paper aims to critically assess Samuel Bassey's eco-anthropoholism. According to eco-anthropology, people are vital pieces of a bigger organism and cannot completely understand the complicated structure and its implementation. A synergistic interaction with all components and harmonious cohabitation with nature may lead to success.

*Keywords: Integrated Environmental Ethics, Anthropocentrism, Non-Anthropocentric, Eco-Anthropoholism.*

**O 18. CURRENT KNOWLEDGE ON ANTIOXIDANT ACTIVITY AND INHIBITORY PARTICULARITIES OF CISTUS INCANUS (L.) COLLECTED IN CENTRAL ALBANIA**

Orjeta LITA<sup>1</sup>

<sup>1</sup>*Faculty of Biotechnology and Food, Agricultural University of Tirana, Koder Kamza, Tirana 1000, Albania*

E-mail: [orjetalita29@gmail.com](mailto:orjetalita29@gmail.com)

**ABSTRACT:** Cistus genus (Cistaceae) comprises several medicinal plants used in traditional medicines to treat several pathological conditions including hyperglycemia. These include Cistus incanus still not fully explored as a source of metabolites with therapeutic potential for human diseases. The recent developments of Albanian highlight that economy of Medicinal & Aromatic Plants (MAP) hold a very special place within national economy. Following historical data during the communist era, exports of MAPs earned close to \$50 million. Based on scientific findings of the Cistus species extracts, this genus offers an adequate reserve of active phytochemicals since many have been used to create drugs. Therefore, this review work can serve society by providing a global view on Cistus L. sp. regarding pharmacological potentials and their chemical profiles. The main purpose of this article is based on analyses of essential oils extracted from Cistus incanus and further on analyses conducted in premises of Essential Laboratory in Elbasan. The essential oil, isolated by hydrodistillation from fresh lowers of Cistus incanus L. collected in different localities River Shkumbini watershed, was investigated by Gas chromatography (GC) method. The GC analysis of the oil revealed the presence of 18 constituents, of which  $\alpha$ -Pinene (22%), camphor (19.1%), terpineol (13.20%), camphene (11.09%) and linalil acetate (5.23%) were the major, constituting altogether almost 74.60% of total composition. Based on our first analyses data it can be confirmed that antioxidant Activity and inhibitory particularities of Cistus incanus (L.) collected in Shkumbini Basin are of significant importance, while further comprehensive studies are needed.

*Keywords: Central Albania, Cistus sp., Phytochemicals, Plant Species, Medicals, GC*

**O 19. CURRENT KNOWLEDGE OF CONSERVATION STATUS OF FISHES OF VJOSA RIVER (ALBANIA)**

Nertila MUÇOLLARI<sup>1</sup>

<sup>1</sup>*Faculty of Biotechnology and Food, Agricultural University of Tirana, Koder Kamza, Tirana 1000, Albania*

E-mail: *nertilamucollari@gmail.com*

**ABSTRACT:** The river Vjosa is a 270 km long, large river which has its origin in the Pindos mountains in northern Greece and except for the first 10 km, this system is free flowing and not constrained by any longitudinal barriers. From the Albanian border downstream, where the Sarandoporos a major tributary enters, the river is referred to as Vjosa. In the region of Permet, the river shows an incision channel pattern, as sediment erosion exceeds sediment deposition, and it immerses into alluvial sediments. From this point on the river's course is characterized by large, braided sections alternating with constrained riverbeds and gorges wherever the river breaks through major geological barriers. Fish species constitute the major biodiversity component which is depending on dynamic and structure of habitats within Vjosa itself.

As of recent knowledge there are 30 fish species described for the Vjosa, of which 17 are freshwater species, seven are saltwater species, four show anadromous behavior, one namely *Anguilla anguilla*, is catadromous and for one species (*Atherina boyeri*) amphidromous behaviour is described. Apart from records of four alien species the Vjosa shows a high level of endemism with nine of 26 native species (35 percent) being endemic to the Balkans. This fact is also represented in the conservation status of the fish fauna. According to the national Albanian red list three species are endangered (*Acipenser naccarii*, *Acipenser sturio*, and *Aspianus fasciatus*) and two vulnerable (*Petromyzon marinus* and *Platyichthys flesus*). IUCN considers three species to be critically endangered (*Acipenser naccarii*, *Acipenser sturio* and *Anguilla Anguilla*) and additionally *Gobio skadarensis* is categorized as endangered. The Bern convention lists three species in Annex II (strictly protected fauna species) (*Acipenser naccarii*, *Acipenser sturio* and *Aspianus fasciatus*) and two as in Annex III (*Alburnoides aff. Praspensis*, *Chondrostoma vardarensis*, *Pachyichthys pictum* and *Petromyzon marinus*). There is a severe lack of knowledge concerning these systems compared to other systems in Europe, resulting in limited available data information about these species and their population status. This means that more species than previously thought could be severely threatened.

*Keywords: Vjosa River, Threats, Conservation, Fish Species, Vulnerable*

**O 20. EVALUATION OF THE PHYTOCOENOSES CONDITION OF AGROLANDSCAPES  
OF THE RIGHT-BANK FOREST-STEPPE OF UKRAINE BY ANTHROPOGENIC  
FACTORS**

Yeuheniia TKACH<sup>1\*</sup>, Viktoriya STERODUB<sup>1</sup>, Svitlana OKHRIMENKO<sup>1</sup>

<sup>1</sup>*Institute of Agroecology and Environmental Management of NAAS*

E-mail: *bio\_eco@ukr.net*

**ABSTRACT:** To establish the impact of anthropogenic factors on the phytodiversity of phytocoenoses, an assessment was made by integral indicators: hemerobia, the degree of destruction of phytocoenoses, and the degree of synantropisation using indices of anthropogenic transformation of flora. The general tendency of hemerobia growth from semi-natural phytocoenoses to agrocenoses was established. It was determined that the main part of semi-natural phytocoenoses in terms of the coefficient of destruction of phytodiversity belongs to the IV and V classes of destruction – above average with a certain violation of edaphotopes and with a high agrotransformed edaphotop. According to the synanthropisation indexes, it was found that apophytisation processes in semi-natural phytocoenoses of the Central Forest-Steppe of Ukraine prevail over adventitious processes, which confirms the anthropogenic impact of synanthropic species on the state of phytocoenoses and the creation of optimal conditions for their further spread.

*Keywords: Phytocoenosis, Agro-Landscape, Anthropogenic Factors, Hemerobia, Synanthropisation*

**O 21. SOLAR POWER ELECTRICITY IN PUBLIC BUILDINGS ECO-FRIENDLY ENERGY SOLUTION– CASE STUDY THE ALBANIAN FOOTBALL ASSOCIATION BUILDING**

Aelita MANI<sup>1\*</sup>, Astrit BARDHI<sup>2</sup>, Nives LAMÇE<sup>3</sup>

<sup>1</sup>*Luarasi University, Tirana, Albania*

<sup>2</sup>*Polytechnic University of Tirana (UPT) Faculty of Electrical Engineering, Albania*

<sup>3</sup>*South East European University, Tetovo, North Macedonia*

E-mail: *mani\_alb@yahoo.com, asibardhi@gmail.com, nives.shtylla@gmail.com*

**ABSTRACT:** During the last years, there has been a surge in electricity demand, coupled with a significant surge in energy prices. The primary source of electricity generation in Albania is hydroelectric plants, and this relies heavily on atmospheric conditions. According to data from the Albanian Energy Corporation, these hydroelectric plants typically provide about 70–80% of the country's annual electricity consumption. The conversion of solar energy into electricity through photovoltaic panels (PV) has become increasingly cost-effective and technologically advanced, spanning various cost-efficient applications, which has raised the interest of private companies and several photovoltaic parks are in various stages of development in Albania. This article focuses on an in-depth examination of electricity production via photovoltaic panels for a public building, namely the Albanian Football Association. Based on measurements taken at the facility, it is evident that the electricity generated by the PV panels is sufficient to meet the energy demands of the company, with occasional surplus energy production. It is crucial to emphasize that the installation of photovoltaic panels for electricity generation is both necessary and highly efficient. Representing a key facet of renewable energy sources, solar energy has garnered significant interest as a sustainable and eco-friendly energy solution.

*Keywords: Solar Power, Energy, Eco-Friendly Energy, Public Building, Sustainability.*

## **1. INTRODUCTION**

Electricity today is a basic human need. In 2022 most of the nation's electricity production is based on fossil fuels such as oil, coal, gas. These fossil materials are exhaustible and their burning has harmful effects on the environment, climate and health. Due to these limitations and with the continuous increase in the demand for electricity, the only alternative left is the production of electricity from renewable energy sources such as the use of energy from solar power, wind, hydropower, biomass, and geothermal. Now with the technologies we have, it is a smart solution to produce free electricity from nature.

### **1.1. Electricity Production in Albania**

Historically during the last decades, electricity production in Albania primarily has relied on hydropower plants, with the most significant ones located along the Drin River. Over the past decade, Albania has seen the construction of numerous small hydropower facilities, with a total of around 600 MW in capacity (Energy Regulatory Entity-ERE, 2021). Consequently, electricity generation is contingent on weather conditions and precipitation. Albania's energy production sector encounters challenges in providing sufficient electricity to consumers, stemming from issues such as a scarcity of primary energy resources, the absence of a natural gas distribution network, restricted transmission line capacities for interconnection, and complete reliance on hydropower for energy production.

At the other hand, there has been a significant surge in electricity demand within the country. The electricity generated by power plants at a given time falls short of meeting consumer needs. Consequently, to meet this demand, a portion of electricity is imported from other countries.

Also in recent years, there has been a notable upturn in electricity prices, posing challenges for both residential users and the industrial sector. In certain instances, due to these rising electricity costs, some companies have been compelled to cease their production processes, leading to a ripple effect on the nation's economy.

Proceeding Book of ISESER 2023

In light of the issues plaguing the electricity sector, many consumers are exploring alternative means of obtaining electricity (Solar Power Europe, 2017). One of the most effective methods for electricity production involves harnessing solar energy through the installation of solar panels. Over the past few years, the cost of solar panels has decreased, prompting increased interest from the public and private sector in their adoption.

2. MATERIAL AND METHODS

In this article, we will examine a case study that focuses on electricity generation using solar panels at the facilities of the Albanian Football Federation. The Albanian Football Federation (Albanian: *Federata Shqiptare e Futbollit*; FSHF) is the governing body of football in Albania. The association is based in Tirana, Albania. The installation of photovoltaic panels not only met the Federation's energy needs but also contributed surplus energy to the grid.

The benefits of utilizing solar panels for electricity production include ease of installation, minimal maintenance requirements, a short installation timeframe, and their eco-friendly nature.

However, a drawback is that photovoltaic panels necessitate a significant surface area and generate power exclusively during sunny hours. The sun in one hour radiates enough energy to cover the energy consumption used by people in a year.

2.1. General Overview

Albania, with a favourable geographical position in the Mediterranean basin, has very favourable climatic conditions for the use of solar energy. The high intensity of solar radiation, the duration of this radiation, the temperature and humidity of the air, etc. the Mediterranean climate, with a mild and wet winter and hot and dry summers, determines an energy potential greater than the average energy potential for the use of solar energy.

Most of the energy is the result of direct or indirect activity of the sun. Direct solar energy has begun to be widely used in power generation through solar panels, photovoltaic panels, solar parks, etc.

In the territory of Albania, we have a considerable solar energy potential, there are about 286 sunny days, with up to 2700 sunny hours per year, where many areas are exposed to a radiation ranging from 1185 kWh/m<sup>2</sup> per year to 1700 kWh/m<sup>2</sup> per year.

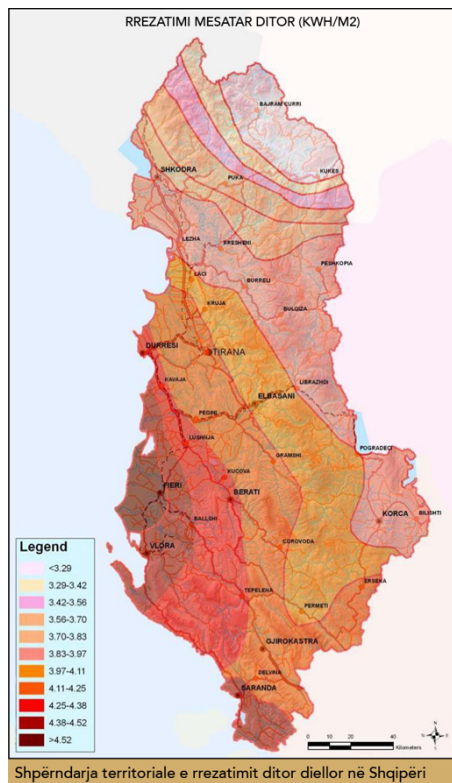

Figure 1. The territorial distribution of the annual sunny hours in Albania

**Proceeding Book of ISESER 2023**

**2.2. Photovoltaic Potential in Albania**

Albania, being located in the Mediterranean region, has a great potential of solar radiation and has suitable conditions to exploit solar radiation throughout the country and especially in the coastal regions.

**Table 1.** Optimum slopes of the installation angle in different countries

Vendodhja	Pjerrësia optimale e këndit të panelit diellor
Tirana	
(Shqipëria)	41°
Prishtina	
(Kosova)	42°
Shkup	
(Maqedonia)	42°
Podgorica	
(Mali I zi)	42°
Berlin	
(Gjermani)	52°
Athina	
(Greqi)	37°

Albania has an increased consumption of electricity in the summer, while the local production of electricity in the summer is smaller. This is because;

- a) Over 95% of energy in Albania is produced by hydropower plants, (in summer there is little rainfall).
- b) Many small hydropower plants cannot operate during the summer months, as water is needed for agriculture.
- c) The energy demand of the tourism industry is mainly focused on the period June - October. In these 5 months, about 80% of the accommodation is about ¾ of the annual energy needs
- d) Albanian agriculture in summer has high energy consumption, which is necessary to irrigate their fields. This is mainly done by electric pumps, or pumps with fuel generators.
- e) Families as well as state institutions use a lot of energy for air conditioners and waste electricity for heating hot water

Table 2 provides statistics regarding electricity production in Albania for the year 2021 :

across all producer categories (ERE, 2021). Notably, Table I illustrates that Korporata Elektroenergjitike Shqiptare J.s.c. (KESH), a publicly owned company, made the most significant contribution to energy production in 2021. Additionally, the data in Table I indicates that photovoltaic facilities generated 40,756 MWH, constituting approximately 0.5% of the total energy production for the year 2021. Albania, owing to its advantageous location in the Mediterranean region, boasts favourable climatic conditions for leveraging solar radiation in electricity generation. The energy potential of solar energy is determined by factors such as the intensity and duration of solar radiation, temperature, humidity, and other related variables.

Albania's territory is situated in the western portion of the Balkan Peninsula along the eastern coast of the Adriatic and Ionian seas. Geographically, it spans between latitudes 39° 38' - 42° 38' and longitudes 19° 16' - 21° 04'. Within our country's borders, there exists a significant solar energy potential, with numerous areas receiving annual radiation ranging from 1,185 kWh/m<sup>2</sup> to 1,700 kWh/m<sup>2</sup>. Notably, the western part of Albania, particularly the southwest region, enjoys substantial solar energy resources, which can reach up to 2,200 kWh per year.

Figure 1 delineates an isoline marking 1,500 kWh/m<sup>2</sup> per year, effectively dividing Albania's territory into two nearly equal segments (NANR, 2015). Each square meter of horizontal surface within this delineated zone has the practical potential to receive up to 2,200 kWh/m<sup>2</sup> annually. Irrespective of prevailing weather conditions, the same surface typically captures approximately 1,700 kWh per year.



**Table 2.** Energy production of the year 2021

Type of generation	Yearly energy
PPE/ hydropower	877,726
PPE/ hydropower	951,505
Private hydropower	1,425,989
Lanabregas hydropower	27,504
Ashta hydropower	295,245
Photovoltaic plant	40,756
Hydropower manage by	5,343,974
TOTAL	8,962,699

Table 3 presents data on the average solar energy production capacity in various regions over the course of the year. The data from the Tirana and Vlora regions, where public services and industrial operations are concentrated, reveal that the daily solar energy capacity surpasses that of other regions.

**Table 3.** Yearly radiation (kWh/m<sup>2</sup> per day)

Region	Shkoder	Diber	Tirana	Vlora	Korça	Saranda
January	1.70	1.55	1.80	2.15	1.90	1.90
February	2.30	2.30	2.50	2.85	2.70	2.40
Marty	3.35	3.25	3.40	3.90	3.40	3.60
April	4.50	4.15	4.20	5.00	4.40	4.80
May	5.45	5.25	5.55	6.05	5.60	5.80
June	6.10	5.85	6.40	6.80	6.40	6.80
July	6.50	6.25	6.70	7.20	6.80	6.10
August	5.55	5.45	6.05	6.40	5.90	4.80
September	4.45	4.35	4.70	5.15	4.70	3.60
October	2.90	2.90	3.20	3.50	3.10	3.20
November	2.10	1.85	2.15	2.40	2.10	2.10
December	1.70	1.50	1.75	1.85	1.80	1.80

Table 4 provides information on the solar plant installations in Albania up to 2021, as well as the solar energy production in the year 2021.

**Table 4.** Yearly solar energy production

Solar plant	Installed capacity	Grid connection	Energy production
	MW	kV	MWH
“seman2sun”	2	35	4,021
"Sonne"	2	35	4,001
“aed solar”	2	35	4,001
“age Sunpower"	2	35	3,950
“Seman Sunpower”	2	35	4,049

“Semanisolar”	2	35	3,950
ES 2019	2	35	4,304
“Smart watt	2	35	4,290
RTS	2	35	3,668
Statkraft	2	35	13
AEE	2	10	4,469

Solar energy holds great promise as a future energy source due to its potential as an abundant, renewable, and widely distributed natural energy reserve. It is both plentiful and clean, requiring no additional expenses, and it poses no environmental pollution risks (Alirezaei et al, 2016).

**2.3. Residential Solar Systems**

Large photovoltaic systems are called residential solar systems. They typically provide electrical energy for large installations such as hotels, hospitals, schools, factories, etc., and offer a wide range of load application possibilities. These systems produce from 500W to 4000W with a 12V, 24V, or 48V battery system, depending on the system's power capacity (see Figure 2).

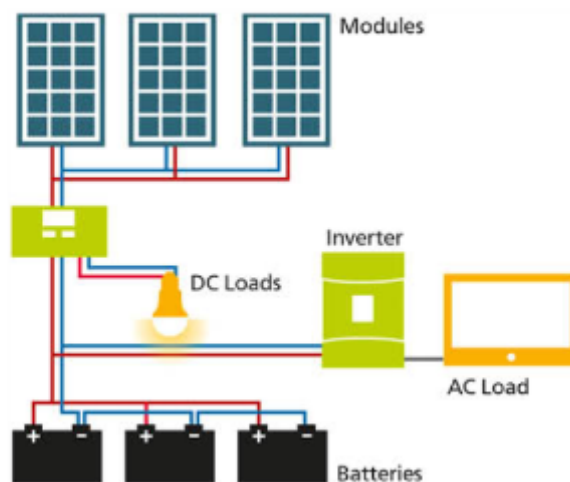

**Figure 2.** Residential dual-connection DC/AC system

**2.4. Solar Energy's Impact on The Power Grid**

Using photovoltaic technology for electricity generation has brought about significant enhancements in the efficient utilization of water resources in Albania. Furthermore, the deployment of photovoltaic systems has substantially curtailed the need for electricity imports from external regions. Currently, the process of obtaining permits to establish power facilities, such as solar or wind farms is encumbered by excessive bureaucracy. Should the energy market become more open, especially with regard to photovoltaic technology, it would exert a noteworthy influence on the energy sector. In fact, recent years have witnessed the issuance of licenses for the construction of several photovoltaic parks with power capacities ranging from 2 to 100 MW.

However, as the number of solar installations increases within the power grid, certain challenges have emerged. The primary issue encountered pertains to power quality, as pointed out by Mohamed A.E. and Zhengming Zh. in 2010 (Mohamed & Zhengming, 2010). Apart from the fundamental harmonic, the voltage and current waveforms produced by the inverter exhibit high-order harmonics.

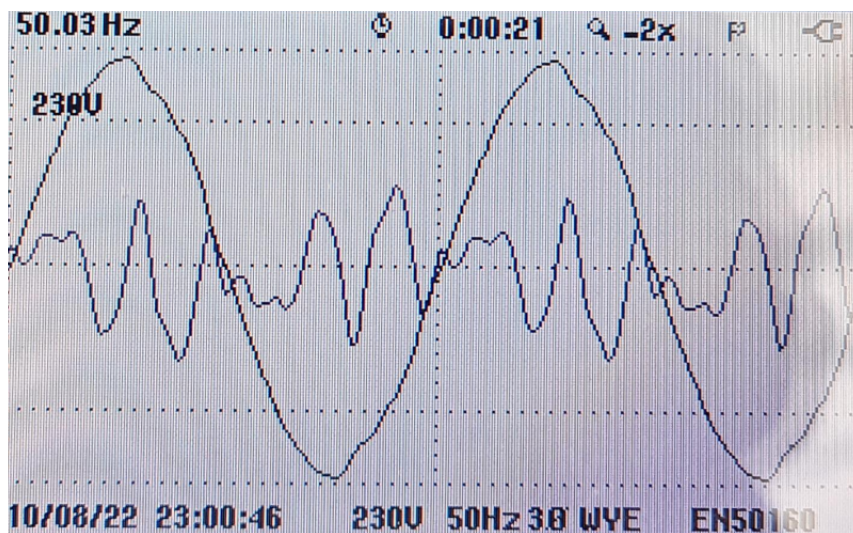

Figure 3. Voltage and current waveform of the inverter.

Figure 3 displays the distorted voltage and current waveforms at the inverter's output. Furthermore, the introduction of nonlinearities, alongside nonlinear loads, can be attributed to harmonic sources like non-sinusoidal waveforms emitted by solar PV inverters, as highlighted by Ahsan S. et al. in 2021 (Ahsan et al., 2021). Presently, inverters are expected to feature high-quality switching, producing pure sinusoidal waves. However, substandard inverters mostly produce modified sine waveforms for current and voltage at their output, leading to contamination of the low-voltage (LV) grid (Chidurala, et al. 2014), where the current spectrum is dominated by the 5th and 7th-order harmonics.

The presence of high-order harmonics in the voltage output of the inverter poses issues for the power grid. Consequently, steps should be taken to mitigate these problems, such as the installation of reactors in series, as proposed by Zhang Y. et al. in 2019 (Zhang et al., 2019).

Hence, prosumers participating in net metering programs need to introduce both active and reactive power into the grid (as indicated by Sara E. et al. in 2013). In many instances, the existing transmission and distribution lines are insufficient to accommodate the energy injection from solar panels. Therefore, besides establishing photovoltaic facilities, it becomes essential to contemplate the creation of new substations and expand the transmission and distribution power lines. When solar panels generate electricity, there is an elevation in voltage levels beyond the permissible limit.

Additionally, another challenge associated with generating energy using photovoltaic technology is the abrupt fluctuations in energy output caused by weather conditions. These fluctuations place pressure on hydropower plants, which play a crucial role in stabilizing the energy supply within the power system.

### 3. DISCUSSIONS AND FINDINGS

#### 3.1. Photovoltaic Panels at The Albanian Football Federation

The photovoltaic system has been installed in the "Albanian Football Federation" facility at the beginning of 2021 year. The building is situated at Liman Kaba, Nd 5, Entrance 1, Administrative Unit 5, Tirana, Albania. The Federation's central offices are located on the building's terrace, and the decision to install solar panels stems from the desire for clean energy and to reduce the monthly electricity expenses. The investor is attracted to this project due to its alignment with legal requirements and its adaptability to changes in the Electricity Distribution Operator Sh.A (or OSHEE) network.

As previously mentioned in the introduction of this paper, there has been a growing fascination with generating electricity by installing photovoltaic panels in the past years. In this section, we will delve into a case study that explores the installation of these panels in the Albanian Football Federation facility.

The investor will utilize the energy generated by this PV system to meet their own needs, consequently reducing their electricity bills.

Table V shows the energy consumption and billing by OSHEE for the month of September for each year of the period 2020-2023. The figures of the September 2020 are before the installation of

**Proceeding Book of ISESER 2023**

photovoltaic elements connected to the electrical system, while the rest ( figures of the years 2021, 2022, 2023) are after installation and use of the photovoltaic system.

**Table 5.** Energy consumption, and energy billing by OSHEE for the September 2020 /2021/2022/2023

Albanian Football Federation invoice by OSHEE				
Bill Period	KWH (Active)	KVArH (Reactive)	Peak	Total Amount ALL
September/2023	10224	0	2464	284,153
September /2022	21680	0	-	477,233
September /2021	38080	0	-	566,730
September /2020	132880	0	-	1,977,554

Table 5 obviously indicates the significant decrease of the energy consumption and billing from the year 2020 (conventional function) and the year 2023 (use of the photovoltaic system). Comparison of the two years 2020 and 2023 indicates a decrease by 85.6%.

Our country's current strategy places high value on the use of renewable energy as an economic development priority. Hence, the objective of this project is to employ renewable energy for power supply.

The modules chosen for this system are JA Solar (JAM72S30 525-550/MR), which meet the necessary European CE certification standards. They have dimensions of 2279 X 1134 X 35 mm and offer a panel power rating of 540 W.

There are many contemporary inverters which are equipped with internal components that, leveraging the maximum DC power they receive, automatically adapt their output impedance to optimize power output. The typical efficiency range for inverters, which is both recommended and suitable for this scenario, falls between 96-98%. Furthermore, the inverter serves as a safety mechanism for the system. It is designed to disconnect its output in the event that voltage, current, or frequency surpasses the predefined limits. In this context, the solution would involve using a single inverter with a nominal power capacity exceeding the photovoltaic system's power production by up to 120%.

**4. CONCLUSIONS**

In summary, given Albania's favourable solar radiation conditions, it holds the potential to generate energy from solar plants. Solar power is a highly promising and sustainable energy source for the future. After examining the content of the article, the following key points can be drawn:

- Solar energy is both cost-free and limitless.
- Solar power is environmentally friendly and does not produce pollution.
- Utilizing photovoltaic plants for electricity production can lead to more efficient water resource utilization within the country.
- Solar energy doesn't release greenhouse gases or harmful waste products.
- Solar power is especially beneficial for generating electricity in remote areas or where expanding the utility grid is costly.
- Solar panels, thanks to their straightforward design and low maintenance expenses, are primarily used for power generation.
- Efforts should be made to enhance the construction of new power lines and substations within the electric distribution and transmission networks to incorporate energy from photovoltaic plants.
- The energy market, particularly in terms of granting licenses for residential and industrial photovoltaic plant installations, should be liberalized.

**REFERENCES**

Ahsan S. M., Khan H. A., Hussain A., Tariq S., Zaffar N. A., (2021). Harmonic Analysis of Grid-Connected Solar PV Systems with Nonlinear Household Loads in Low-Voltage Distribution Networks. *Sustainability*, 13, 3709. [https:// doi.org/10.3390/su13073709](https://doi.org/10.3390/su13073709).

**Proceeding Book of ISESER 2023**

- Alirezaei, M., Noori, M., & Tatari, O. (2016). Getting to net zero energy building: Investigating the role of vehicle to home technology. *Energy and Buildings*, 130, 465–476. <https://doi.org/10.1016/j.enbuild.2016.08.044>
- Chidurala, A.; Saha, T.K.; Mithulananthan, N.; Bansal, R.C. (2014). Harmonic emissions in grid connected PV systems: A case study on a large scale rooftop PV site. *In Proceedings of the 2014 IEEE PES General Meeting Conference & Exposition, National Harbor, MD, USA, 27–31 July 2014*; pp. 1–5.
- ERE 2021, *Annual Report*.
- Mohamed A.E., Zhengming Zh.. (2010). Grid-connected photovoltaic power systems: Technical and potential problems—A review. *Renewable and Sustainable Energy Reviews* (Volume 14, Issue 1) National Agency of Natural Resources (AKBN): [www.akbn.gov.al](http://www.akbn.gov.al)
- OECD (2023), Electricity generation (indicator). doi: 10.1787/c6e6caa2-en
- Sara E., Vijay V., Gerald H., Brian K., Jeffrey L., 2013. Impact of increased penetration of photovoltaic generation on power systems. *IEEE Transactions on Power Systems* (Volume: 28, Issue: 2).
- Solar Power Europe (2017). *Global market outlook for solar power, 2017–2021*. <https://resources.solarbusinesshub.com/solar-industry-reports/item/global-market-outlook-2017-2021>.
- Zhang, Y.; Ma, C.; Lian, J.; Pang, X.; Qiao, Y.; Chaima, E. (2019). Optimal photovoltaic capacity of large-scale hydro-photovoltaic complementary systems considering electricity delivery demand and reservoir characteristics”. *Energy Convers. Manag*, 195, 597–608

**O 22. IMPACT OF SOLID WASTE MANAGEMENT SYSTEM DURING THE COVID-19  
PANDEMIC PERIOD**

Zoran Sapuric<sup>1\*</sup>, Sukru Dursun<sup>2</sup>, Hysen Mankolli<sup>3</sup>

<sup>1</sup>*University American College, Skopje, N.Macedonia*

<sup>2</sup>*Konya Technical University, Konya, Turkiye*

<sup>3</sup>*Independent Environment Researcher, Illinois, USA*

E-mail: *sazoran@hotmail.com, sdursun@ktun.edu.tr, hysenmankolli@yahoo.com;*

**ABSTRACT:** The new type of Coronavirus (COVID-19) has disease characteristics and first emerged as an epidemic in the Wuhan municipality of China in December 2019. It has reached Europe since the beginning of 2020. In response to this situation, in many European countries, various restriction measures have been implemented at the national level to limit temperature change and both waste production and waste transformation organization have been observed. Although the COVID-19 pandemic continues to affect Europe to this date, this report focuses on the first “wave” between February and June 2020. The information presented focuses on this period unless otherwise stated. Pandemic and related restrictions may be imposed, the municipality has brought different conditions regarding waste management. Local governments retain a lot of power to provide for cleaning staff costs and improvements to address staff shortages. The pandemic has made it difficult for local government to provide municipal waste services to residents. At first, as the pandemic progresses and quarantines are imposed in many countries, utilities and municipal waste operators are forced to continue adapting their waste management systems and new transfers. The key view for many local waste authorities has been to ensure staffing, particularly when collecting potentially generating waste. Collection of research papers and packaging scraps has continued throughout the quarantine period, and breakthroughs have been experienced when separate collection is offered. Participants in the surveys stated that their big earnings increase at the same frequency as always. The different causes of the disease that occur include personal deficiency, increased production of the household, etc. specify.

*Keywords: COVID-19, Pandemic, Municipal Solid Waste, Solid Waste Management*

## **1. INTRODUCTION**

The emergence of the novel coronavirus (COVID-19) disease has attracted global attention since December 2019. It is a contagious virus that starts with respiratory symptoms. It has been tried to be protected with personal protective equipment and personal isolation rules. Coronavirus Cases: 500 Millions; Deaths: 6 Millions Worldwide. It was first seen in Wuhan province of China, 468.9 tons of medical waste are generated every day in association with COVID-19. In Indonesia (Jakarta) that the medical waste scale reached 13,000 tons apx 60 days after people were first infection. Currently, millions of contaminated face masks, gloves and materials for diagnosing, detecting and treating SARS-CoV-2 and other human pathogens are undergoing the irreversible process of becoming infectious waste. This, in turn, will cause environmental and health problems if they are stored, transported and handled improperly [3]. Moreover, due to the increased healthcare waste owing to the COVID-19 pandemic, the threat that unsafe disposal of medical waste will spill over into environmental pollution is palpable and immediate [11]. Consequently, one of the many problems that will inevitably occur is contagious waste, which, if not managed properly, may be the root cause of severe diseases and environmental problems. One of the effects of Covid-19 pandemic on medical waste was to increase the generation of this type of waste, which in the studied hospitals were found to be 0.95 to 3.51 kg/bed/day.

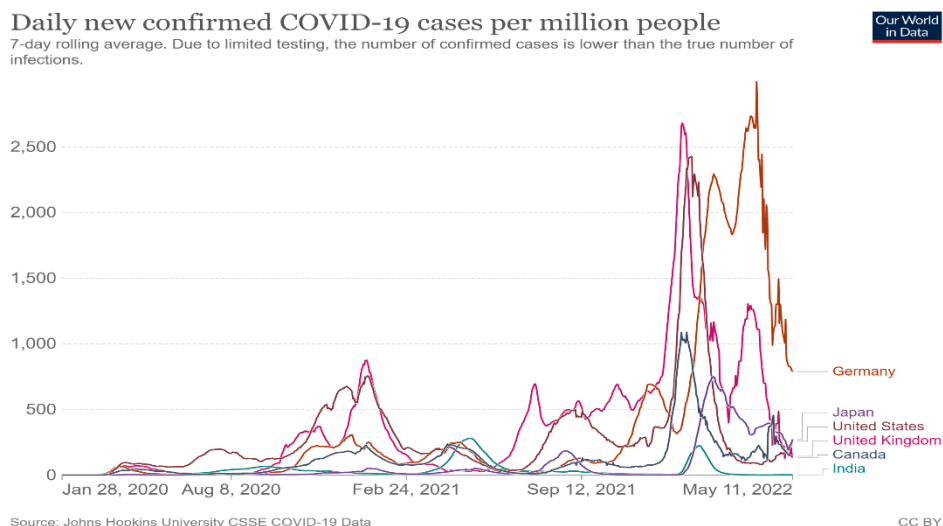

Figure 1. Aily new confirmed Coid-19 cases from Jan. 2020 to May 2022

Tens of thousands of tones of extra medical waste from the response to the COVID-19 pandemic has put tremendous strain on health care waste management systems around the world, threatening human and environmental health and exposing a dire need to improve waste management practices, according to a new WHO report. The WHO Global analysis of health care waste in the context of COVID-19: status, impacts and recommendations bases its estimates on the approximately 87,000 tones of personal protective equipment (PPE) that was procured between March 2020- November 2021 and shipped to support countries' urgent COVID-19 response needs through a joint UN emergency initiative. Most of this equipment is expected to have ended up as waste. Today, 30% of healthcare facilities (60% in the least developed countries) are not equipped to handle existing waste loads, let alone the additional COVID-19 load. Recommendations include using eco-friendly packaging and shipping, safe and reusable PPE (e.g., gloves and medical masks), recyclable or biodegradable materials; investment in non-burn waste treatment technologies, such as autoclaves; reverse logistics to support centralized treatment and investments in the recycling sector to ensure materials, like plastics, can have a second life.

As of April 22, 2022, 54,000 tons of CMW (COVID medical waste) per day has created an additional burden on the environment. Face mask, gloves, protective gear, goggles, disinfectant containers.

## 2. THERMOCHEMICAL TECHNOLOGIES

In general, personal protective equipment and medical waste are mainly made of plastic polymer, including PP, PE, PVC, PE's, PET and rubber latex. Therefore, there is a need for conversion technologies that can effectively purify such materials and provide adequate disinfection. Use of medical waste as an energy source: It is homogeneous. The amount is great. It has low humidity. Sterilization is required.

Incineration: High temperature incineration (combustion) is the most widely adopted technology to effectively dispose of various medical wastes and kill infectious pathogens. It raises relatively high environmental concerns due to high CO<sub>2</sub> emissions and high additional fuel consumption to reach and be stable at a temperature of more than 800 °C. All these possible emissions from the combustion of medical wastes must be controlled with appropriate flue gas treatment. Almost half of the operating cost of the incinerator is used for air pollution treatment.

Thermochemical Technologies: Thermal degradation of PE (HDPE and low-density polyethylene (LDPE)) begins when the temperature approaches 430 °C and ends at 500 °C. PP basically has a similar decomposition temperature to PE but slightly lower, ranging from 420 to 480 °C. PS has the lowest decomposition temperature of 380-440 °C. PET begins to degrade when the temperature approaches 400 °C and stops at around 500 °C, producing CO, CO<sub>2</sub>, methane and light hydrocarbons. PVC degrades in two continuous steps.

## Proceeding Book of ISESER 2023

*Carbonization:* Carbonization results in the release of volatile matter producing homogeneous solid carbonized (charcoal-like, char) products. The solid product has higher energy density due to increased carbon content and decreased oxygen content, excellent grindability, hydrophobicity and stability (stable and long storage possibility). A smaller oxygen/carbon ratio is achieved due to the release of volatile matter, resulting in reduced auto-ignition during grinding. Carbonization is divided into 2 different processes as dry and wet carbonization.

*Dry carbonization (Torrefaction):* Dry roasting is called light pyrolysis and slow pyrolysis. It is a thermochemical process carried out in an almost inert atmosphere and the materials are slowly heated under ambient pressure and a temperature of 200–300 °C. Torrefaction requires raw materials with a low moisture content (such as less than 15% by weight). Therefore, general medical wastes, especially the wastes mentioned above, can be incinerated directly without the need for drying, as they are basically dry.

*Wet Carbonization (Hydrothermal Carbonization):* It is one of the hydrothermal treatments adopted to produce uniformly carbonized material at high temperature (typically ranging from 180 to 280 °C) and a saturated pressure of 2-10 MPa. It is suitable for material with relatively high moisture content, as the drying step can be skipped. Subcritical water accelerates the reaction by acting as a solvent and reagent during the reaction. The solid product of hydrothermal carbonization is often referred to as hydrochar.

*Pyrolysis:* It is the thermal degradation of long chain polymeric molecules into shorter and less complex molecules under an inert or oxygen-deprived atmosphere, in the presence or absence of catalysts. The pyrolysis products can be a mixture of solid, liquid and gas. It can produce high amount of liquid product in wide temperature range. According to their properties, the resulting products are not only suitable for use as fuel, but also can be used as chemical raw materials. It has low carbon emissions due to lower carbon monoxide (0.8–3.9 %) and carbon dioxide (1.0–9.1 vol.) formation compared to combustion. There are two types: thermal and catalytic pyrolysis.

*Thermal Pyrolysis:* Thermal pyrolysis is a pyrolysis that evaluates material using thermal energy without a catalyst. Since the process is endothermic, energy must be supplied to the process. Thermal pyrolysis is a complex process consisting of polymer chain breaking, crosslink formation, side chain elimination and side chain crystallization.

*Catalytic Pyrolysis:* It is basically similar to thermal pyrolysis in terms of process and conditions; The main difference is in the presence of the catalyst. The catalyst is used to increase the reaction rate by lowering the activation energy of the reaction. Therefore, by using the catalyst, a high reaction rate can be achieved at a lower temperature, ultimately reducing the energy requirement and operating cost of the process.

*Gasification:* Gasification is a process that heats materials at high temperature under a controlled atmosphere, converting carbon materials into a mixture of carbon monoxide, hydrogen, carbon dioxide, methane, and a longer chain of hydrocarbon gases. The catalyst can be used to lower energy and drive product yield. Gasification products can be used as a fuel or chemical feedstock (syngas), depending on their composition. It is classified in 2 ways as Air Gasification and Vapor Gasification.

*Air Gasification:* Air gasification is the process of gasification using air or a mixture between oxygen and inert gas (usually nitrogen) as the atmosphere. *Steam Gasification:* Vapor gasification involves steam in the gasification atmosphere, thus making it possible to produce hydrogen-rich gas. Due to this feature, the products of this process are more suitable to be used as chemical raw materials.

### 3. RESULTS

Masks, gloves and protective gowns, which are the main defense tools in the fight against coronavirus and protection, are turning into a growing waste problem worldwide. Uncollected waste, after being dragged by winds and rains, can enter the sewer and enter the water. To reduce the burden of wastes and environmental pollution, both industrial and municipal wastes should be recycled and reused. Moreover, hazardous, and infectious medical waste should be properly managed by municipal and hospitals. Therefore, proper strategies should be adopted to control environmental degradation **and wastes**. It has been observed that the number of COVID medical wastes from personal protective equipment used during the current COVID-19 outbreak is very large and these wastes are considered to have potential as an energy source. There are many options for safely converting COVID medical waste into a usable fuel or heat. Since this type of waste is contagious, a disinfection step should be added or



### **Proceeding Book of ISESER 2023**

integrated with the selected technology. In this study, several major thermochemical conversion technologies, particularly their suitability to dispose of COVID medical waste, are reviewed. These include combustion, carbonization/heating, pyrolysis and gasification. Among these thermochemical conversion technologies, incineration is thought to facilitate a wide variety of medical waste types followed by gasification and pyrolysis. The enormous volume, high caloric content and rapid conversion of COVID medical waste require urgent thermochemical methods.

#### **4. CONCLUSION**

Waste management is crucial in the prevention and control of Corona virus since it may travel in many ways and can survive in a variety of temperature ranges while also having a long life without a host. As a result, the waste created during the treatment of covid patients must be handled appropriately and quickly at the source. There would be fewer risks of transmission if the waste is handled on the spot. The ideal waste management approach should always be to minimize, reuse, and recycle, however, this is not relevant to biological hospital waste. Hazardous biological waste, such as COVID-19 waste, poses a significant risk to humans and requires specific disposal. Such waste is often handled by procedures such as chlorination, combustion, incineration, and so forth. However, all these processes emit hazardous chemicals into the environment and pose a risk to waste handlers. Modern waste technologies such as incineration, pyrolysis, and plasma waste technology may be utilized to entirely treat biological waste. This will not only help to recycle hazardous waste but also prevent the public from additional COVID-19 transmission. Inclusion of the informal sector can be considered a viable way for improving the recycling rate and reducing the waste inflow into final disposal sites in developing countries, due to low technological requirements and economic investments. However, further investigations and efforts should be implemented for understanding the most appropriate strategy for its involvement. In Latin America various pilot project were implemented by the organization of cooperatives including waste pickers that have provided good results. However, in some areas of Asia and Africa this practice is forbidden and represents an obstacle to a formal selective collection system. Therefore, specific patterns should be implemented for each context, exploiting the activities just in place introducing the CE principles, remembering that informal recycling cannot be the only system in action; improving waste collection and selective collection coverage of municipal areas, introducing awareness and information campaigns, implementing appropriate treatment systems with regulations and control agencies, improving final disposal sites and its management, enhancing financial sustainability of the systems and introducing future management plans are all practices required for improving the integrated SWM system of a country, region, municipality or rural area.

#### **REFERENCES**

- Bandela D.R., COVID-19: Here is what you should do to safely dispose your used mask. <https://www.downtoearth.org.in/news/waste/covid-19-here-is-what-you-should-do-to-safely-dispose-your-used-mask-71006>, 2020..
- Bavani M., Hazard in Rubbish Bin, 2020. <https://www.thestar.com.my/metro/metro-news/2020/03/25/hazard-in-rubbish-bin>.
- Ferronato N., V. Torretta, Waste mismanagement in developing countries: A review of global issues, *Int. J. Environ. Res. Publ. Health* 16 (6) (2019) 1060.
- ISWA, Q&A: Waste management & COVID-19 in Singapore. [https://www.iswa.org/fileadmin/galleries/0001\\_COVID/Singapore\\_Waste\\_Management\\_during\\_Covid19.pdf?](https://www.iswa.org/fileadmin/galleries/0001_COVID/Singapore_Waste_Management_during_Covid19.pdf?), 2020.
- Nabizadeh R, Koolivand A, Jafari AJ, Yunesian M, Omrani G. Composition and production rate of dental solid waste and associated management practices in Hamadan, Iran. *Waste Manag Res.* 2012;30(6):619–24.
- Pasalari H, Nabizadeh R, Mahvi AH, Yaghmaeian K, Charrahi Z. Landfill site selection using a hybrid system of AHP-Fuzzy in GIS environment: A case study in Shiraz city, Iran. *MethodsX.* 2019;6: 1454–66.
- Rongmeng J., Jianguo J., Discarded Masks Must Be Properly Disposed of: China Daily Contributors, 2020. <https://www.straitstimes.com/asia/discarded-masks-must-be-properly-disposed-of-china-daily->

**Proceeding Book of ISESER 2023**

- contributors?fbclid=IwAR3gYoymqZ0aQ%20roE58xeNI8uM7Ejswygyh8h9CRtxYnI9YuWgmLqqt6k.
- Saleh HN, Valipour S, Zarei A, Yousefi M, Asghari FB, Mohammadi AA, et al. Assessment of groundwater quality around municipal solid waste landfill by using Water Quality Index for groundwater resources and multivariate statistical technique: a case study of the landfill site, Qaem Shahr City, Iran. *Environ Geochem Health*. 2020;42(5):1305–19.
- Taiwan News, Taipei City Government to reward those who report mask litterers. <https://www.taiwannews.com.tw/en/news/3909264?fbclid=IwAR3gYoymqZ0aQ-0roE58xeNI8uM7Ejswygyh8h9CRtxYnI9YuWgmLqqt6k>, 2020.
- Torkashvand J, Pasalari H, Jonidi-Jafari A, Kermani M, Nasri O, Farzadkia M. Medical waste management in Iran and comparison with neighbouring countries. *Int J Environ Anal Chem*. 2020. <https://doi.org/10.1080/03067319.2020.1759570>.
- Wang J., How Does Chongqing Dispose of Discarded Masks during the Coronavirus Outbreak?, 2020. <https://www.ichongqing.info/2020/02/04/how-does-chongqing-dispose-of-discardedmasksduringthecoronavirus%20outbreak/?fbclid=IwAR3ceYhGZkiyrAF2tMowGRlbJY8-b02uhVTwXIPuIK4k05kMsLynabnjmA>.
- World Bank, Solid Waste Management, 2019. <https://www.worldbank.org/en/topic/urbandevelopment/brief/solid-waste-management>. (Accessed 14 July 2020).
- Worldometers, COVID-19 coronavirus pandemic 2020. <https://www.worldometers.info/coronavirus/>, 2020.

**Proceeding Book of ISESER 2023**

**O 23. A NEW PARADIGM FOR AREA-BASED CONSERVATION; OTHER EFFECTIVE  
AREA-BASED CONSERVATION MEASURE; CASE OF KARACADAG**

Nihan Yenilmez Arpa<sup>1\*</sup>

<sup>1</sup>*General Directorate of Nature Conservation and National Park, Ministry of Agriculture and Forestry  
(Retired since January 2022)*

*United Nations Food and Agriculture Organization, Senior Consultant*

E-mail: [nihanarpa@gmail.com](mailto:nihanarpa@gmail.com)

**ABSTRACT:** Protected areas are the most important cornerstones in the protection of natural resources and biodiversity. At the same time, they provide benefits to residents and are also instruments that contribute to the implementation of international agreements.

They are known by a multitude of names in different countries and are governed according to both nationally and internationally accepted agreements and/or approaches. The International Union for the Conservation of Nature (IUCN) has created a classification system that identifies six categories of protected area according to their management objectives to create a common understanding for each category.

While the protected areas are an essential and continually growing approach to conservation, there is difficulties to applicate universally for the conservation of biodiversity. Therefore, apart from national and regional protected areas, various tools and networks also contribute to the effective in-situ conservation of natural resources and biodiversity. 'Other Effective area-based Conservation Measures' (OECMs) have been recognized as an important opportunity to achieve this aim. The OECMs has the potential to promote a new model for conservation that fosters inclusive approaches and equitably governs land, forests, freshwater and oceans to achieve long-term conservation, as well as social, economic, and cultural wellbeing.

Today, total 828 number of OECMs in the world. For Türkiye, a case study was carried out and an OECM assessment report prepared for Karacadağ Steppes in the scope of "Conservation and Sustainable Management of the Türkiyes' Steppe Ecosystems Project " that was implemented between 2017-2022 by the FAO and the Ministry of Agriculture and Forestry. It is the first case for Türkiye and introduced the OECM approach to the policy agenda as well.

*Keywords: Protected area, Nature conservation, OECMs, Karacadag-Sanliurfa*

**Proceeding Book of ISESER 2023**

**O 24. ARMED CONFLICT AND ITS IMPACT ON THE ENVIRONMENT: PRINCIPLES OF  
JUS AD BELLUM AND JUS IN BELLO**

Miebaka Nabiebu<sup>1\*</sup>, Michael Takim Otu<sup>2</sup>, Amarachukwu Onyinyechi Ijiomah<sup>3</sup>

<sup>1</sup>*Department of Jurisprudence and international Law, University of Calabar, Cross River, Nigeria.*

<sup>2</sup>*Department of Industrial & Commercial Law, faculty of Law, University of Calabar, Nigeria.*

<sup>3</sup>*Department of Jurisprudence and international Law, University of Calabar, Cross River, Nigeria.*

E-mail: [mdlw2004@yahoo.com](mailto:mdlw2004@yahoo.com), [michealtakim@unical.edu.ng](mailto:michealtakim@unical.edu.ng), [amarachukwuijomah@unical.edu.ng](mailto:amarachukwuijomah@unical.edu.ng)

**ABSTRACT:** International humanitarian law and international human rights law are complementary. Both strive to protect the lives, health, and dignity of individuals, albeit from different angles. Humanitarian law applies in situations of armed conflict, whereas human rights, or at least some of them, protect the individual at all times, in war and peace alike. However, both laws can be useful for the environment in terms of armed conflicts. This paper attempts to critically examine whether the Law of Armed Conflict is against the principles of environmental protection. The purpose of this paper is to discuss the impacts of armed conflict on the environment, the pre-armed conflict phase, armed training, the actual war stage, as well as the post-war stage. This paper further narrows the discussion down to: the impact of the Second Sino-Japanese War (1937–1945); the Second World War; the Vietnam War; the War in Afghanistan (1978–2009); and the 2021 Ukrainian–Russian War on the environment. And, lastly, the post-armed conflict phase and its impact on the environment. This paper argues that Armed conflicts in and of themselves always have a disastrous impact on the natural environment. Armed conflict is one of the major causes of the degradation of natural resources. Its training as well as incidence have always occasioned substantial obliteration of the natural environment. The ecological balance gets disturbed due to a lot of human casualties, deforestation effects, and the release of hazardous chemicals as well as hazardous waste by the use of weapons during the armed conflict. This work suggests that There should be innovative jurisprudential techniques devised to adequately deal with the problems of protection and preservation of the environment during armed conflict.

*Keywords: International humanitarian law, Jus ad Bellum, Jus in Bello, 2021 Ukrainian–Russian War.*

**O 25. AN ECOCRITICAL EXAMINATION OF ENVIRONMENTAL ETHICS AND  
CONSERVATION IN THE WORKS OF JOHN STEINBECK**

Edisua Merab Yta<sup>1\*</sup>

<sup>1</sup>*Department of Theatre, Film and Carnival Studies, University of Calabar, Nigeria.*

E-mail: *edisuamerab@gmail.com*

**ABSTRACT:** Myths are a human construct devised as an ideal counterbalance to the forces of nature. The concept of nature is characterized by its timeless and transcendent qualities, as it exists beyond the confines of any specific laws or limitations. In mythological narratives, nature is often portrayed as an eschatological entity, representing life as an ongoing and uninterrupted progression. In his literary works, John Steinbeck portrays the contemporary human psyche's lack of awareness towards the fundamental worldview that perceives nature as a cohesive symbiotic entity, whereby humanity is inherently interconnected. In his literary works, John Steinbeck portrays the contemporary human psyche's lack of awareness towards the fundamental perspective of the primeval worldview, whereby nature is seen as a cohesive and interdependent system, with mankind being an intrinsic component thereto. The primary objective of this study is to analyze John Steinbeck's book through the lens of environmental ethics, sustainability, and conservation. This study posits that Steinbeck, throughout his body of work, consistently emphasizes the interdependence of several elements, including humanity, individual experiences, and the surrounding environment. The characters' comprehension of the interconnectedness of all elements in the natural world enables them to achieve a comprehensive metaphysical perspective on the oneness of the cosmos. This perspective emerges from the many assessments of life and natural laws.

*Keywords: John Steinbeck, Environmental Ethics, Conservation, Ecocritical Examination*

**O 26. AIR POLLUTION AND PUBLIC HEALTH IMPACTS DURING THE COVID-19 PANDEMIC**

Mirela LIKA (ÇEKANI)<sup>1,3</sup>, Sukru DURSUN<sup>2</sup>, Altin DORRI<sup>3</sup>

<sup>1</sup>*Faculty of Natural Sciences, University of Tirana, Boulevard ZOG I, 1001 Tirana, Albania*

<sup>2</sup>*Konya Technical University, Konya, Türkiye*

<sup>3</sup>*Polytechnic University of Tirana, Sheshi "Nene Tereza", nr. 4, Tirane, Albania*

E-mail: [mirela.lika@fshn.edu.al](mailto:mirela.lika@fshn.edu.al), [sdursun@ktun.edu.tr](mailto:sdursun@ktun.edu.tr), [adorri@fim.edu.al](mailto:adorri@fim.edu.al)

**ABSTRACT:** Industrial success often results in relatively high population densities and causes concomitant and sometimes synergistic air, water and soil pollution problems. Petrochemical plants, motor vehicles, metal processing industries and household heaters are just a few of the pollution sources that pollute the environment. Altogether, these problems are widely thought to be associated with high cancer deaths. Although many studies in the literature have examined the issue of changes in air pollutant levels during quarantine in different countries, few have focused on the impact of these changes on health risks. The study compared the 2020 period, which included quarantine (partial closure between March 16 - May 10 and October 30 - December 15), with previous years and the pandemic period to determine how these government-mandated quarantines affected concentrations. NO<sub>2</sub>, O<sub>3</sub>, PM<sub>2.5</sub> and PM<sub>10</sub> and how it affects human health factors including low birth weight, lung cancer, mortality, asthma, non-accidental mortality, respiratory and cardiovascular diseases have been determined. Air quality is important for health, although there are changes in the relative risks of health outcomes based on epidemiology. It was found that the relative changes in pollutant levels during the 2020 restriction period were as follows. Reductions in short-term risks were associated with reductions in PM<sub>2.5</sub> (in pediatric emergency department visits for asthma during the second lockdown) and NO<sub>2</sub> (in hospital admissions for respiratory causes). Long-term risk reductions related to PM<sub>2.5</sub> include low birth weight, mortality rate and lung cancer, and NO<sub>2</sub> has also been stated to be effective in mortality rate. WHO also stated that air pollution poses a major risk to the environment and health. Even more harmful to health is indoor air pollution in large urban areas. It is important to have correct ventilation systems in indoor environments, as particulate matter in aerosols can also harbor pathogens such as viruses and bacteria and therefore be easily transmitted. Air pollution is also one of the biggest challenges of our millennium, and some early studies have highlighted a positive correlation between air pollution and the spread of the virus. Therefore, it is crucial to define what role atmospheric particulate plays in the spread, morbidity, and mortality of the virus.

*Keywords: Pollution, COVID-19, Pandemic, Air pollution, Public health*

## **1. INTRODUCTION**

Air pollution emissions are released from both natural and anthropogenic sources. Human-driven activities aimed at providing necessary goods and services to society are responsible for the anthropogenic share of air pollution. Air pollution emissions occur at many stages in the life cycles of products and services, that is, from raw material extraction, energy acquisition, production and manufacturing, use, reuse, recycling, through to ultimate disposal. Effects of pollutants is direct bearing on the health of animals & man, & planetary biodiversity. Toxic gases & substances present in the atmosphere cause: Retardation of growth, promote ageing, Bleaching of leaves, Necrosis in plants. The degree of damage: Dose of pollutant & Duration of exposure, Loss of valuable plant materials especially around industrial areas damage to physical structures, monuments, and buildings. Microbial pollution of air: A variety of microbes are carried by air, Meteorological conditions (temperature, humidity, solar radiation), Amount of particulate & gaseous pollutants contribute immensely to the variation in the load and type of microbes, Most of the atmospheric microflora emanates from the soil or due to stirring action induced by animal/human activity within the animal houses, The microbes are adsorbed on the dust particles, Carried over long distances under favourable weather conditions (high wind velocity) especially during outbreaks of diseases, A large numbers of organisms (many of them pathogens) can

Proceeding Book of ISESER 2023

be transmitted through air in an area, Animals suffering from respiratory diseases discharge the microorganisms during sneezing & coughing.

For human being: Sneeze can release up to 10,000-10,00,000 droplets, Microbes released by animal & human sources survive in the environment for varying lengths of time, Some organisms may not survive for more than few minutes (Leptospira in dry atmosphere), Can resist the adverse environmental conditions for as long as 28 years (spores of Bacillus anthracis in soil), Brucellae can survive in soil for about one month, Exposure to sunlight causes destruction of many environmental microorganisms (*Mycobacterium* spp.), In soil: mycobacteria can survive for up to 6 months.

COVID-19: The virus that causes COVID-19 is known as SARS-CoV-2, It appears to have first emerged in Wuhan, China, in late 2019 (Fig. 1). The outbreak has since spread across China to other countries around the world. By the end of January 2020, the new coronavirus had been declared a public health emergency of international concern by the WHO. The most reported symptoms include a fever, dry cough, and tiredness, and in mild cases people may get just a runny nose or a sore throat. In the most severe cases, people with the virus can develop difficulty breathing, and may ultimately experience organ failure. Some cases are fatal.

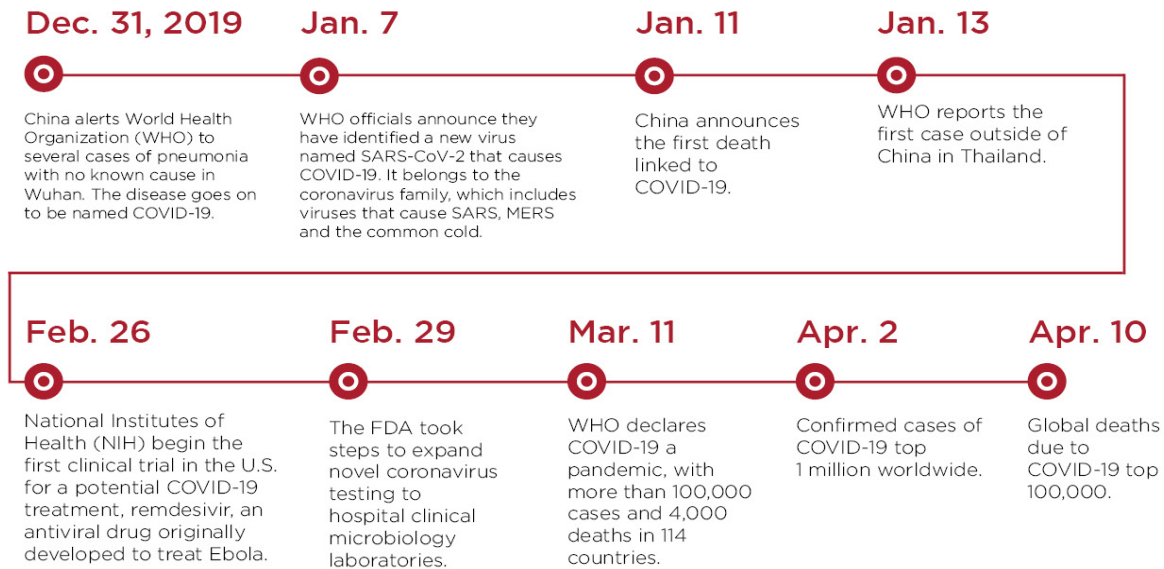
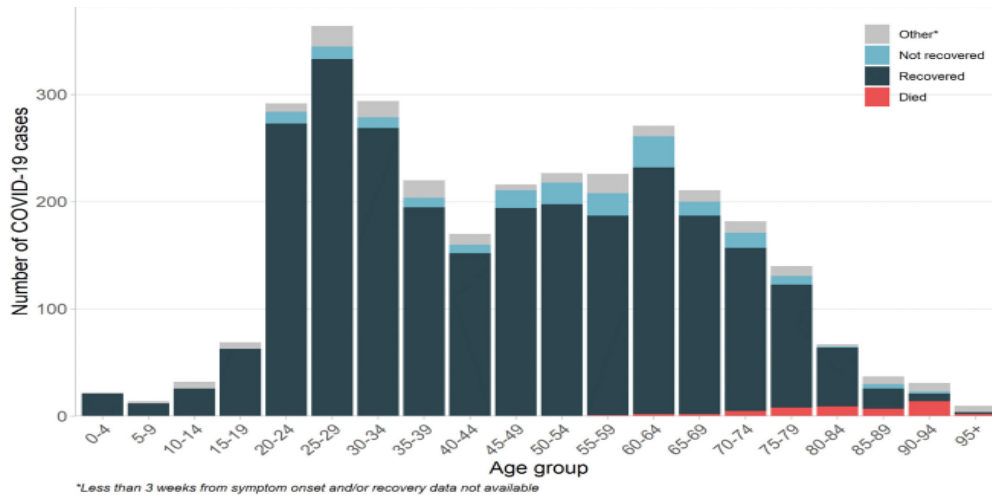

Figure 1. Action schedule for beginning of COVID-19 pandemic period.

Although the amount of infection is low in the group over the age of 20 and over the age of 80, who are not allowed to go out due to the measures taken due to the Covid-19 pandemic, it is seen that the survival rate of those infected with the disease is more difficult, that is, the death rate is higher (Fig. 2). The disease recovery rate is quite high in patients between the ages of 20 and 40. Looking at the death rates from Covid-19 in Asian, European and African countries in Figure 3, it is seen that the highest death rates after the USA are in China and India.



**Interpretation:** Overall, more than 85% of cases have recovered.

**Figure 2.** Total number of COVID-19 cases by age group and health status.

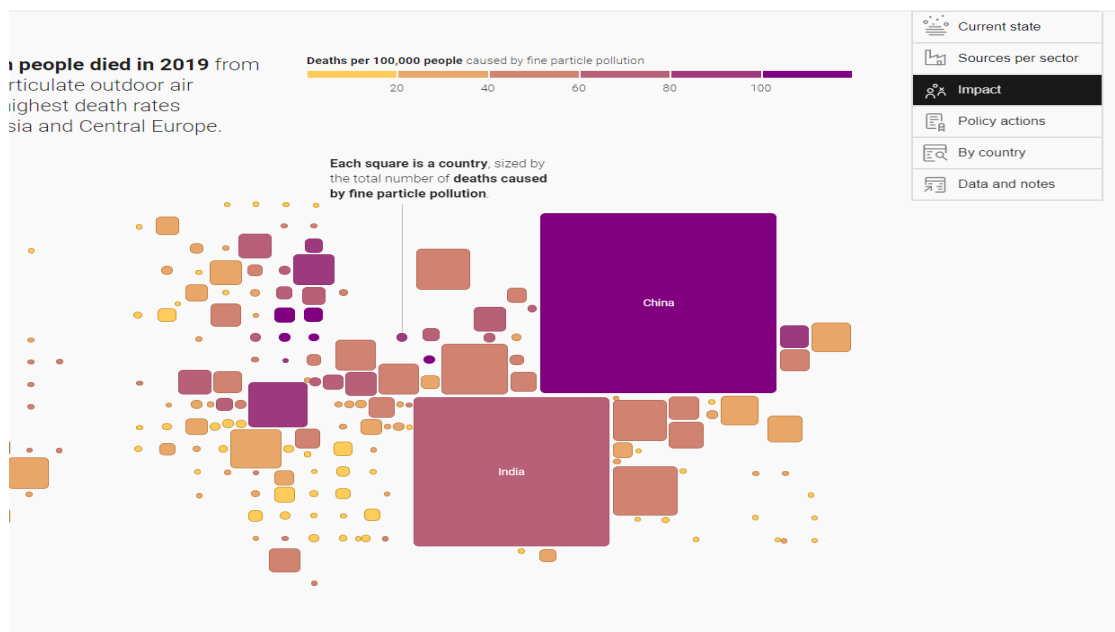

**Figure 3.** Death rates from Covid-19 infection in European-Asian and African countries.

The amount, size, sources and effects of PM in the atmospheric environment are quite complex. Figure 4' The effects of PM pollution on the human body are shown in Figure 5. Of these organs, the highest impact rate is on the respiratory system. In addition to the high chance of these organs coming into contact with particulate matter, PM properties are also an important factor.



Proceeding Book of ISESER 2023

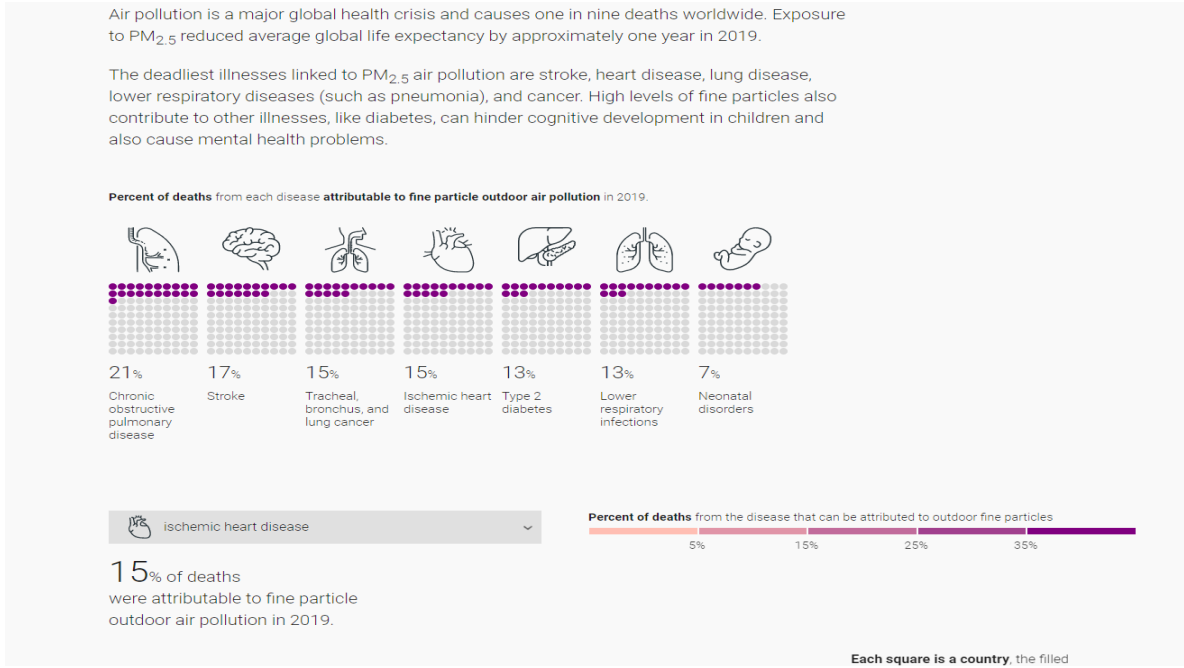

Figure 4. Rates of PM pollution affecting organs in the human body.

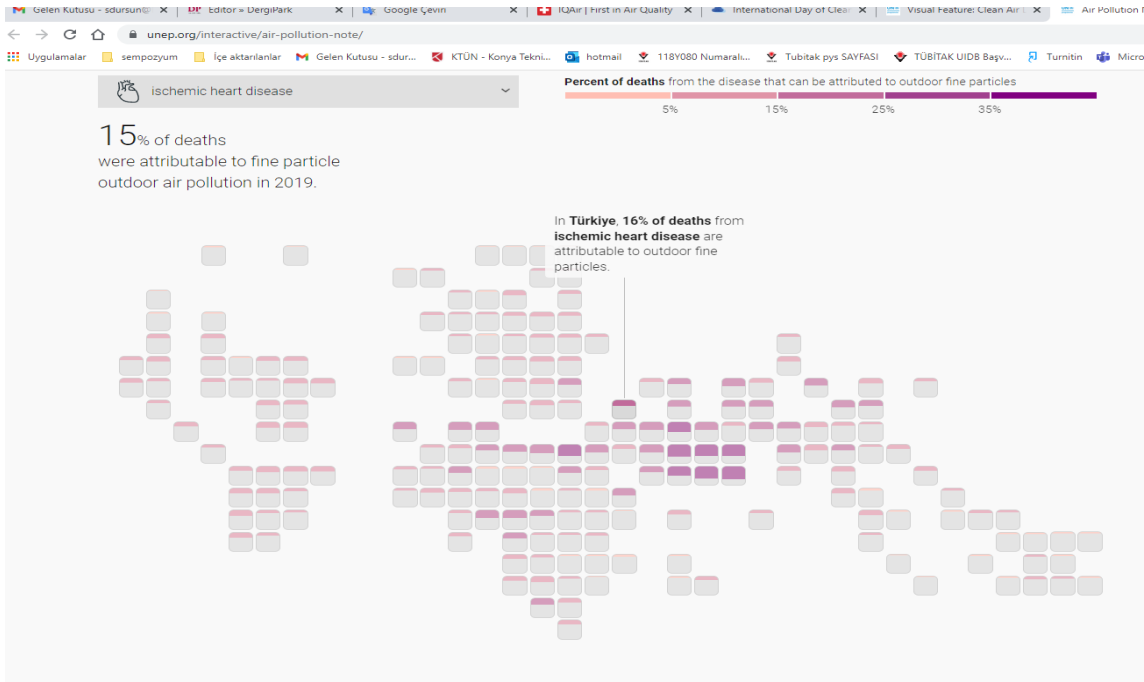

Figure 5. 15% of deaths in Türkiye were attributable to fine particle outdoor air pollution in 2019.

When European-Asian countries are examined in African countries, it is seen that there are high rates of Covid-19 rates and deaths in the Middle-Far East countries and the northern part of Africa (Figure 5). Figure 6 shows instantaneous PM<sub>10</sub> concentrations in the world. Figure 7 shows current PM<sub>10</sub> values in Türkiye and its surroundings. Although many factors affect PM values, it appears to be quite high in certain regions. These values are relatively close to the intensity of Covid-19.

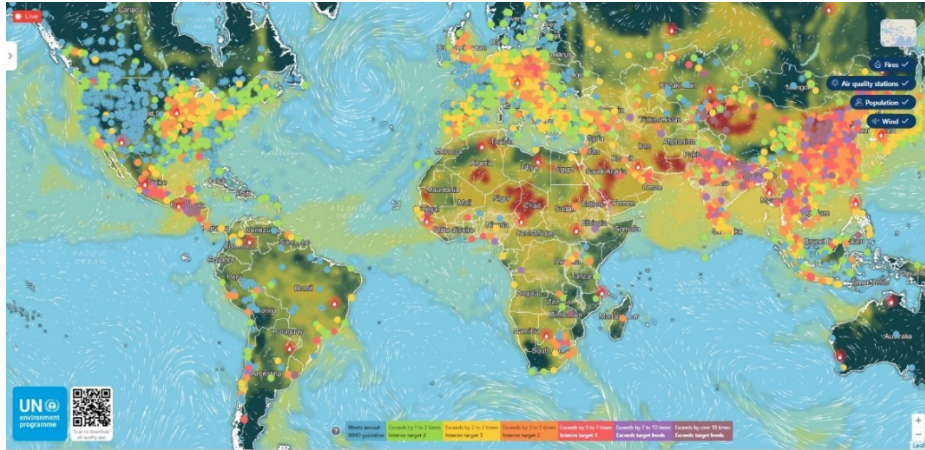

Figure 6. Worldwide PM<sub>10</sub> pollution, <https://www.iqair.com/unep>

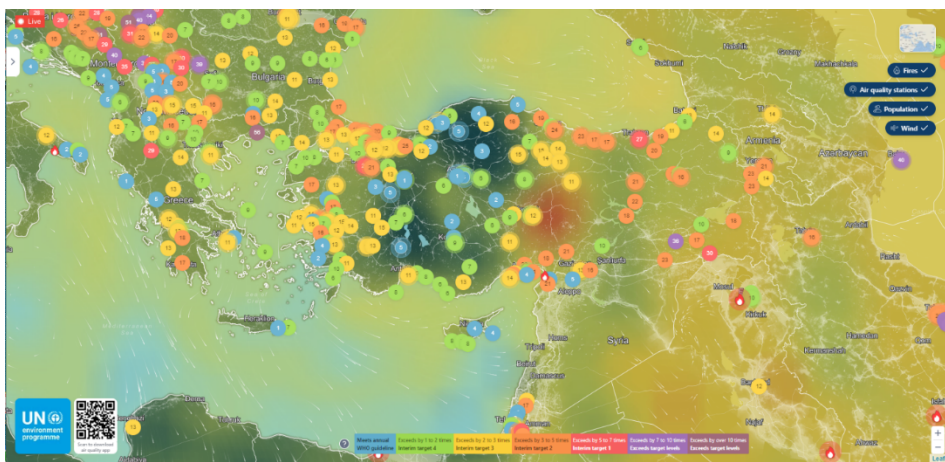

Figure 7. Türkiye PM<sub>10</sub> concentration distribution.

Many measures are taken to reduce PM<sub>10</sub> Concentrations in the majority of countries in the world (Figure 8). The rates of measures taken in European countries and the USA are higher. Rates in African countries are lower. Of the 9 different methods of taking measures determined in Turkey, success has been achieved in 8 of them, and measures are being developed in one of them (Figure 9).

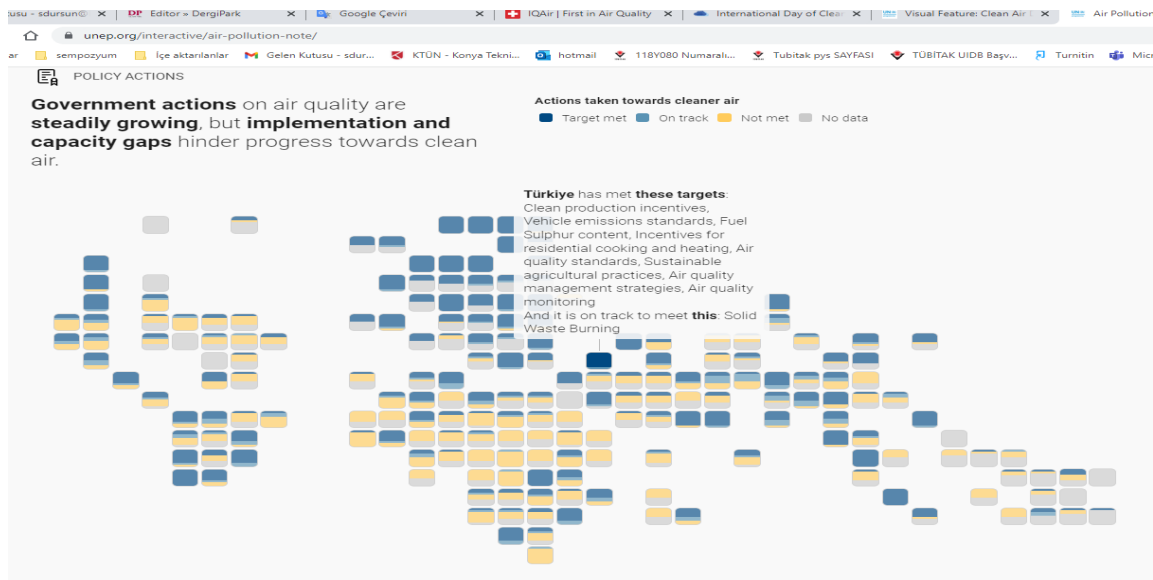
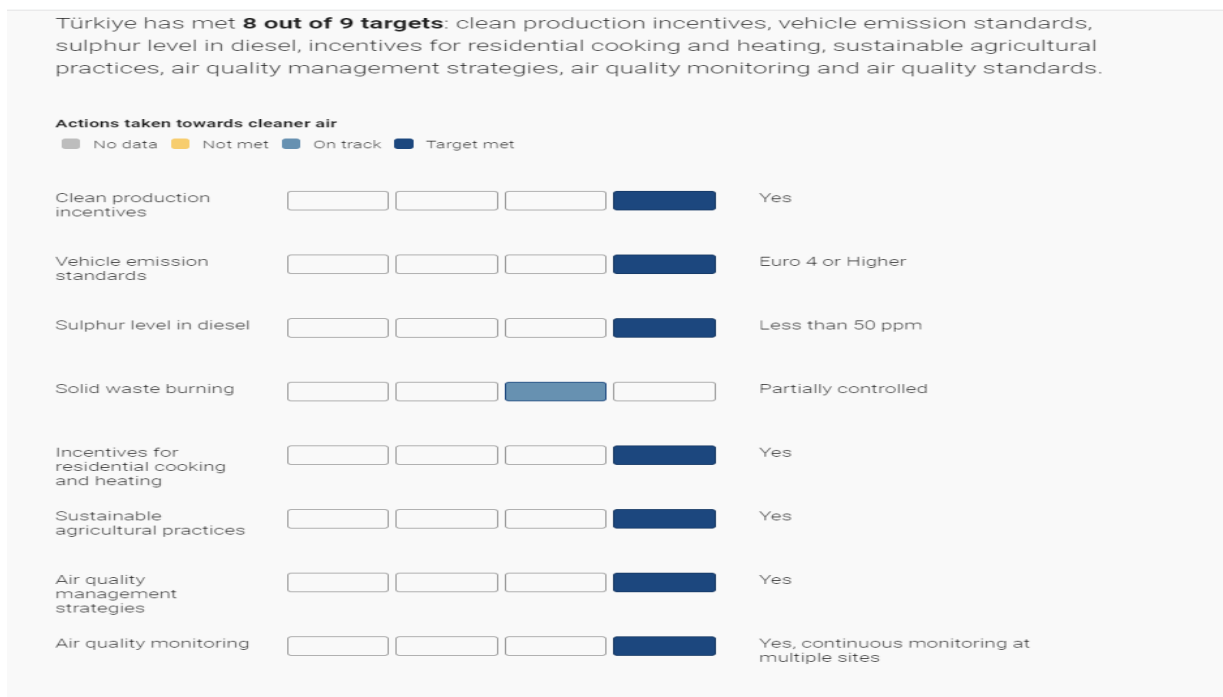

Figure 8. Government actions on air quality are steadily growing, but implementation and capacity gaps hinder progress towards clean air.



**Figure 9.** Türkiye has met **8 out of 9 targets**: clean production incentives, vehicle emission standards, Sulphur level in diesel, incentives for residential cooking and heating, sustainable agricultural practices, air quality management strategies, air quality monitoring and air quality standards.

Control of air pollution: Minimize the production & release of pollutants near the animal or human dwellings, Control of dust particles: by improving sanitary conditions within the houses, Frequent washings of floor & equipment: controlling the dust within the buildings, Vacuum cleaners: used effectively, Proper ventilation: a prompt clearance of foul gases & particulate pollutants. Filters can be installed to check the entry of external contaminants, Use of laminar air flow systems for closed compartments/ cabins, Allows unidirectional passage of air through cellulose acetate filters.

## 2. CONCLUSION

The goal of any clean air policy is to develop strategies to reduce the risk of adverse effects on human health and the environment as a whole caused by ambient air pollution. With the existence of very susceptible populations and the ability to detect effects even if they are infrequent, we may be confronted with situations when the concept of thresholds is no longer useful in setting standards to protect public health. The principle of eliminating adverse effects with an adequate margin of safety even for the most susceptible groups may not be realistic. However, risk reduction strategies are and will continue to be powerful tools in promoting public health. The development of such strategies requires not only qualitative, but also quantitative knowledge on the most relevant adverse effects. PM<sub>2.5</sub> pollutant was investigated; it is primarily the pollution that occurs due to the fuels burned for transport purposes. In addition, due to the low air temperature values, people prefer to use public transport, walk or bike, etc. The use of private vehicles instead of using them also increases the pollutant values. In EU countries and Turkey, the limit value of PM<sub>10</sub> (Particulate Matter) has been determined as 50 µg/m<sup>3</sup> as a result of 24-hour measurement. As a result of the annual measurement, the limit value has been determined as 40 µg/m<sup>3</sup>. The working group noted that the recommendation to use PM<sub>2.5</sub> as indicator for PM related health effects does not imply that PM<sub>2.5</sub> is the only relevant parameter to characterize PM pollution. Therefore, it was recommended to set up a more comprehensive monitoring program in different European cities (possibly including PM<sub>10</sub>, PM<sub>2.5</sub>, composition, gases), which, in combination with properly designed health studies, could lead to an additional gain in knowledge on the health effects of ambient air pollution in the coming years.

**Proceeding Book of ISESER 2023**

**3. RECOMMENDATIONS**

Ensuring energy efficiency and ensuring the use of renewable energy sources (wind, geothermal, solar energy) are among the most important reduction activities in reducing air pollution. On the other hand, government should make the necessary legal arrangements and carry out inspections. It should review the legislation according to the conditions of the day and make the necessary improvements. The public should be informed by preparing trainings on the importance and protection of the environment. As a solution proposal as a result of research and analysis; Attention should be paid to the fuels used during industrial activities and the flue filters in the facilities. To reduce the exhaust and gases from motor vehicles, we can ensure less pollution by using public transportation, at least in an environmentally friendly way such as cycling or walking.

**REFERENCES**

- Abbey, D.E. et al. Long-term inhalable particles and other air pollutants related to mortality in nonsmokers. *American journal of respiratory and critical care medicine*, 159: 3730150382 (1999).
- Environmental Protection Agency (U.S.) 1979. "Protecting visibility: an EPA report to Congress. Research Triangle
- Environmental Protection Agency (U.S.) 1997c. "Health and Environmental Effects of Ground-Level Ozone". July
- Environmental Protection Agency (U.S.) 1997d. "Air Quality Criteria for Particulate Matter". September 22, 1997.
- Environmental Protection Agency (U.S.), 1997b. "Risk Impact Assessment Report for the Particulate Matter and
- Environmental Protection Agency (U.S.). 1985. Developing Long-term Strategies for Regional Haze: Findings and
- Forman T. 1979. The Pine Barrens of New Jersey: An Ecological Mosaic. In: Pine Barrens. Ecosystems and Landscape.
- Greenland, S. Basic Problems in Interaction Assessment. *Environmental health perspectives* 1993; 101: 59–66 (1993).
- Health Effects Institute. Diesel Emissions and Lung Cancer: Epidemiology and Quantitative Risk Assessment. Available on: <http://healtheffects.org/pubs-special.htm>, Health Effects Institute, June 1999.
- Mauderly, J.L. Toxicological approaches to complex mixtures. *Environmental health perspectives*, 101: 155–165 (1993).
- Park, NC: Office of Air Quality and Planning Standards". EPA Report no. EPA-450/5-79-008. Available from:
- Putaud, J.P. ET AL. A European Aerosol Phenomenology: physical and chemical characteristics of particulate matter at kerbside, urban, rural and background sites in Europe. <http://ies.jrc.cec.eu.int/Download/cc>, Joint Research Centre, Ispra. Italy. (2002).
- Samet, J. & Jaakkola, J.J.K. The epidemiologic approach to investigating outdoor air pollution. In: Holgate, S.T. et al, ed. Air pollution and health. London, Academic Press 1999.
- United States EPA Environmental Protection Agency. Health assessment document for diesel exhaust. Prepared for: Washington, D.C., United States Environmental Protection Agency, EPA/600/8–90/057E, July 2000.
- United States EPA. Air Quality Criteria for Particulate Matter (Third External Review Draft) Environment Protection Agency, 600/P-99/002aB,. <http://cfpub.epa.gov/ncea/cfm/partmatt.cfm?ActType=default>. (2002).
- URL: <http://www.epa.gov/ncea/partmatt.htm>
- URL: <http://ttnwww.rtpnc.epa.gov/naaqsfm/o3health.htm>
- WHO Air Quality Guidelines for Europe, Second edition. Copenhagen, WHO Regional Office for Europe, 2000 (WHO Regional Publications, European Series, No 91).
- WHO, World health report 2002. Geneva, World Health Organization, 2002.

**O 27. ESTIMATING OF EMISSIONS FROM CARGO AIRPLANES: A COMPARATIVE ANALYSIS AT TURKISH AIRPORTS**

Ayşegül Toy<sup>1\*</sup>, Abdullah Oktay Dündar<sup>2</sup>

<sup>1</sup>*Necmettin Erbakan University, Konya, Türkiye*

<sup>2</sup>*Necmettin Erbakan University, Konya, Türkiye*

E-mail: *ayshegultoy@gmail.com, aodundar@erbakan.edu.tr*

**ABSTRACT:** The transportation sector has a significant portion in the emissions released into the atmosphere. In recent years, the greenhouse gas emissions from airplanes have been increasing as the aviation sector has been developing and negatively affecting climate change. In this study, greenhouse gas emissions from cargo flights between 2015-2020 at five airports in Turkey (Sabiha Gökçen, Atatürk, Istanbul, Adnan Menderes and Esenboğa) where air cargo traffic is intense were calculated. The Tier 2 method developed by IPCC (Intergovernmental Panel on Climate Change) was used in these calculations. The total amount of emissions from cargo flights at the relevant airports between 2015-2020 was measured as 775.565.104,46 kg CO<sub>2</sub>e. Atatürk Airport, where the busiest airplane traffic is experienced between 2015-2020, ranks first in all emission types and fuel consumption. Between 2015-2019, Esenboğa Airport ranked last in total CO<sub>2</sub>e emissions, while Adnan Menderes Airport ranked last in 2020. The highest total CO<sub>2</sub>e emission was measured as 139.473.435 kg CO<sub>2</sub>e at Atatürk Airport in 2020. The lowest total CO<sub>2</sub>e emission was measured in 2018 at Esenboğa Airport as 221.207 kg CO<sub>2</sub>e. The highest CO<sub>2</sub>e emission per LTO was measured as 8.711 kg CO<sub>2</sub>e at Esenboğa Airport in 2016. The lowest CO<sub>2</sub>e emission per LTO was measured as 4.804 kg CO<sub>2</sub>e at Sabiha Gökçen Airport in 2020. It has been observed that there was a continuous airplane traffic increase at Atatürk and Istanbul Airport between the relevant years and the total CO<sub>2</sub>e emissions increased continuously. A fluctuating change has been observed at the other three airports. As a result of the study, it was determined that the air cargo traffic in Turkey is increasing day by day after the opening of Istanbul Airport and the amount of emissions emitted from airplanes has also increased accordingly. The study concludes that taking the necessary measures to reduce the environmental impacts of air transportation can be effective in reducing greenhouse gas emissions even if airplane traffic increases.

*Keywords: Air Cargo Transportation, LTO, Greenhouse Gas Emissions, Tier 2*

*This study is derived from Ayşegül Toy's masters's thesis titled "Estimating of Emissions from Cargo Airplanes: A Comparative Analysis at Turkish Airports" at Necmettin Erbakan University, Institute of Social Sciences.*

**O 28. GRAPHICAL USER INTERFACE DESIGN FOR REMOVAL OF OUTLIERS DATA:  
YESILIRMAK RIVER EXAMPLE**

Eda Göz<sup>1\*</sup>, Zübeyde Zengül<sup>2</sup>, Erdal Karadurmuş<sup>2</sup>, Mehmet Yüceer<sup>3</sup>

<sup>1</sup>*Ankara University Engineering Faculty, Chemical Engineering Department, 06100, Ankara*

<sup>2</sup>*Hitit University Engineering Faculty, Chemical Engineering Department, 19200, Çorum*

<sup>3</sup>*İnönü University Engineering Faculty, Chemical Engineering Department, 44280, Malatya*

E-mail: [aaaaaa esemizer@enga.nkara.edu.tr](mailto:aaaaaa esemizer@enga.nkara.edu.tr)

**ABSTRACT:** Rapid population growth and increased industrial activities have threatened water resources recently. To overcome these problems, important measures become to protect water resources and monitor pollution. Within this context, online monitoring stations have been used for water pollution monitoring. More frequent monitoring and collection of a large amount of data have been carried out thanks to online monitoring stations.

In recent years, advancements in data mining and computer technologies have enabled the development of models for various parameters. However, data preprocessing and data quality are important in model development.

In this study, removing outlier values in the dataset using the data collected from an online monitoring station on the Yeşilirmak River between 2007 and 2009. Dissolved oxygen (luminescence dissolved oxygen, LDO), temperature, pH, conductivity, total organic carbon (TOC), nitrate nitrogen (NO<sub>3</sub>-N), and ammonium nitrogen (NH<sub>4</sub>-N) data was evaluated. Median, Mean, Grubbs, Gesd, and interquartile range methods were used to remove outlier data. After the models developed, all models were integrated into a graphical user interface developed in the MATLAB environment. As a result of this study, the median algorithm removed more data points among the outlier data-removing methods.

*Keywords: Outlier Detection, Statistical Approach, River Water Quality Data*

**O 29. ACRYLAMIDE/SODIUM ACRYLATE/POLYETHYLENE GLYCOL/KAOLIN  
COMPOSITE HYDROGELS FOR REMOVAL OF METHYLENE BLUE: DYE  
ADSORPTION ISOTHERMS AND KINETICS**

Maha Almezgagi<sup>1</sup>, Gülcihan Güzel Kaya<sup>1</sup> and Hüseyin Deveci<sup>1\*</sup>

<sup>1</sup>*Konya Technical University, Department of Chemical Engineering, Konya, Turkey*

E-mail: *E-mail: mahaalmzgagi3@gmail.com; ggkaya@ktun.edu.tr; hdeveci@ktun.edu.tr*

**ABSTRACT:** In recent years, removal of dyes by adsorption process from aqueous solutions has received great interest. Especially, utilization of facile synthesized and cheap composite hydrogels as adsorbent is in the spotlight for dye adsorption [1]. This study focused on methylene blue adsorption by acrylamide/sodium acrylate/polyethylene glycol/kaolin composite hydrogels which were pH sensitive materials. Maximum methylene blue removal efficiency was specified as about 73% using 0.05 g composite hydrogel at pH 7 for 120 min. According to adsorption data obtained at optimum experimental conditions, methylene blue adsorption isotherms and kinetics were investigated. The adsorption data was well fitted to Langmuir adsorption isotherm model and pseudo-second-order kinetic model. The results indicate that the hydrogel composites, even in low amount, are efficient adsorbents at neutral pH for a cationic dye removal.

*Keywords: Adsorption, Hydrogels, Isotherms and Kinetics*

*[1] Hu, X.-S., Liang, R., Sun, G., Super-adsorbent hydrogel for removal of methylene blue dye from aqueous solution, Journal of Materials Chemistry A, 2018, 6, 17612-17624.*

## **O 30. COMPARISON OF METHODOLOGIES TO CALCULATION CARBON FOOTPRINT IN LIVESTOCK FARMS**

Feyza AYDIN<sup>1</sup>, Selda UZAL SEYFI<sup>1\*</sup>

<sup>1</sup>*Selçuk University, Faculty of Agriculture, Agricultural Structures and Irrigation Department, 42021,  
Türkiye*

E-mail: [seldauzal@selcuk.edu.tr](mailto:seldauzal@selcuk.edu.tr)

**ABSTRACT:** The concepts of carbon footprint have emerged in order to investigate the share of intensive livestock farming in global warming and to clearly determine production-consumption outputs. It is estimated that 15% of the world's greenhouse gas emissions come from animal breeding. It is known that a significant portion of these emissions originate from enteric fermentation and manure management systems. This study was carried out to evaluate and compare the methodologies used to calculate the carbon footprint resulting from animal breeding, which has become very important in recent years. In the study, the methodologies (TIER 1, TIER 2, TIER 3) used in calculating the carbon footprint by the International Panel on Climate Change (IPCC) were examined. It can be said that a significant part of the carbon footprint of animal products originates from feed production.

*Keywords: Livestock Businesses, Carbon Footprint, Global Warming,*

### **1. INTRODUCTION**

Existing resources are becoming insufficient or even depleted due to reasons such as the increasing world population and human needs, changing lifestyles, and increasing expectations and demands. This has pushed humanity to increase food production and animal production, which has a large share in food production, and to develop technologies based on it (Thornton 2010).

The increasing world population has brought with it many environmental problems as a result of the needs it brings. Climate change, decrease in underground and aboveground biodiversity, and most importantly, the problem of global warming are among these.

Global warming; Greenhouse gas emissions, which mostly occur as a result of human activities, cause temperature increases on the world. The concept of carbon footprint has emerged in order to investigate the share of intensive farming enterprises in global warming and to clearly evaluate their production and consumption outputs.

Carbon footprint; The indicator converted into carbon equivalent(CO<sub>2</sub>eq) for products and services throughout the entire life discussion from cradle to grave is called carbon footprint(Weidmann 2008). The carbon footprint includes the total amount of all greenhouse gases, especially carbon dioxide (CO<sub>2</sub>), methane (CH<sub>4</sub>) and nitrous oxide (N<sub>2</sub>O), emitted by an activity(Aycaguer2001).

It is estimated that globally the livestock sector is responsible for 15% of greenhouse gas emissions. 80% of these emissions come from ruminant animal products, which involve enteric fermentation and manure management (Perrson 2015). In global measurements, it is expressed as a ton, and in measurements per animal it is expressed as a unit (kg CO<sub>2</sub>eq per year).

In Brazil (Cerri et al. 2016), beef production on 22 farms with a cumulative pasture area of 60,000 hectares observed that the largest source of greenhouse consumption (89-98%) was from animals (67-79% by enteric fermentation, 20% by 33% manure).

This study was prepared to introduce and compare carbon footprint calculation methods from livestock farms.

### **2. METHODS USED TO CALCULATE CARBON FOOTPRINT**

The most common method used to measure carbon footprint is the IPCC (The Intergovernmental Panel on Climate Change) approach. According to the IPCC approach, carbon footprint is calculated by methods called Tier 1 (Simple calculation method), Tier 2 (Mid-level calculation method), Tier 3 (Detailed calculation method).



**Proceeding Book of ISESER 2023**

**2.1. Simple calculation method (Tier 1)**

Tier 1 is approaching; Estimated emission rates calculated using the Tier 2 method with data from the literature are used. It is a simplified method that includes selected data according to animal species, subcategories and climate zones or temperatures (IPCC 2019).

It may be suitable for most animal species where enteric fermentation is not a major source or where advanced classification data are not available.

**2.1.1 Tier 1a**

An advanced Tier 1 method can be applied to countries that have different production systems, particularly where low and high productivity systems coexist, or whose agricultural production systems are transitioning from low to high productivity.

High efficiency systems; 100 percent market-oriented high-efficiency systems with high levels of capital input and high levels of overall herd performance. Feed is purchased from the local or international market or produced intensively on the farm. It is based on animal feeding systems that use feed (e.g. high-quality grass) and concentrates in closed production systems, or supplementary grazing, or animal feeding systems that provide high rates of daily weight gain on improved pastures (FAO et al. 2014).

Low productivity systems; Systems driven by the local market or self-consumption, with low capital inputs requirements and low overall herd performance levels, typically using large areas or backyards for production. Locally produced forages (residues from intercrops) or low-quality pastures represent the main forage products. These are animal feeding systems where daily weight gain is low (Table 1) (FAO et al. 2014).

**Table 1.** Tier 1 and Tier 1a Enteric Fermentation Emission Factors for Cattle and Buffalo

ASIA	Category	E.F.	Comment
<i><b>Cattle:</b></i> The commercialized dairy sector is experiencing fundamental changes due to the increase of large farms with intensive production systems based on seasons and feeds. They are more complex than other structures of each type.	<b>Dairy cattle</b>	78	average milk production 3,200 kg head <sup>-1</sup> year <sup>-1</sup>
	High efficiency systems	96	average milk production 5,000 kg head <sup>-1</sup> year <sup>-1</sup>
	Low Productivity Systems	71	average milk production 2,600 kg head <sup>-1</sup> year <sup>-1</sup>
	<b>Other Cattle</b>	54	It includes mature males, mature females, growing and reserve animals, and calves.
	High efficiency systems	43	
	Low Productivity Systems	56	
<i><b>Buffalo:</b></i> Buffaloes are generally swamp type. Buffaloes are raised by farmers as a draft power source when they are young.	<b>Buffalo</b>	76	It includes breeding and working challenges, growing animals and calves.

**2.2. Mid-level calculation method (Tier 2)**

According to Tier 1, the annual population estimate is taken into account. Animal population and feed intake estimates for each animal are taken into account for each subcategory. It aims to accurately estimate the amount of feed taken for the accuracy of methane production by enteric fermentation. For accurate feed estimation, we need to know the animals, their productivity, diet quality and management conditions.

The following information is required for one of the representative animal categories defined:

1. Annual average population
2. Average daily feed (energy) intake (megajoules (MJ) per day or kg per day)
3. Methane conversion factor (Y<sub>m</sub>) percentage of feeder panel energy converted to methane

**Proceeding Book of ISESER 2023**

1. Annual average population

$$N_T = \text{Animal life} \times (\text{NAPA}/365)$$

$N_T$ : Number of livestock species in the country / category  $T$  (equivalent to the annual average population)

$NAPA$  = number of animals produced annually

2. Daily feed intake (megajoules (MJ) per day or kg per day)

In general, data on average daily feed intake, especially for grazing livestock, are not available. Consequently, the following general data should be collected to estimate the feed intake of a representative category of animals;

A. Weight (kg): Body weight data should be obtained from representative sample studies or statistical databases, if readily available. Annual average weight is required for each category of animals (e.g. mature beef cows). For young animals, their weight at birth, at weaning, at one year of age, or at the time of slaughter if slaughtered within the year is required.

B. Weight gain per day (kg)<sup>-1</sup>: It is usually collected for livestock and growing animals. It is generally assumed that the net weight of mature animals does not change over the course of a year.

C. Nutritional status-activity: Table 2

D. Daily milk production (kg/day): Lactating sheep, dairy cows and buffalos must be registered. Lactation days per year or estimated seasonal production along with daily production should be reported divided by days per season.

**Table 2.** Activity Coefficients Appropriate to the Nutritional Status of the Animal

Situation	Definition	Ca (Activity Coefficient)
<b>Cattle and Buffalo (Ca unit is dimensionless)</b>		
Barn	Animals are confined to a small area (tethered, corral, barn). They obtain feed by consuming little or no energy.	0
Pasture	Animals obtain feed by consuming a small amount of energy. It is kept in areas where there is sufficient roughage.	0.17
Grazing in large areas	Animals graze in open fields or rough terrain and expend significant amounts of energy for feed intake.	0.36

e. Average amount of work done per day (hour day<sup>-1</sup>): For load-carrying animals, the average daily working hours should be recorded.

f. Percentage of females giving birth in a year: It is collected for cattle, buffalos, sheep and goats.

g. Wool growth: To estimate the amount of energy stored for wool production (after drying but before washing) the amount of wool produced in kilograms is needed. For goats, this only applies if the country has the relevant number of fibre-producing goats.

h. Number of offspring: This is limited to female livestock (e.g. sheep) that give birth more than once a year.

i. Digestibility of feed (DE, percent): Table 3

The portion of the gross energy (GE) in the feed that is not excreted in the feces is known as digestible energy (expressed as a percentage). Feed digestibility is often expressed as percentage GE or TDN (total digestible nutrients). Changes in feed digestibility are the main reason for the change in methane emissions and the amount of manure excreted. A 10% change in DE results in an increase of 12 to 20% when estimating methane emissions, and even more (20 to 45%) for the amounts of manure discarded. Feed characteristics should be recorded when developing digestibility data.

**Proceeding Book of ISESER 2023**

J. Dietary crude protein (CP, percent): The total amount of protein present in the animal diet. It was determined by analyzing the nitrogen content in animal feed and multiplying by 6.25. Data on the percentage of CP are required for the indication of nitrogen excretion using the Tier 2 method.

**Table 4.** Equations used to estimate gross daily energy intake

Metabolic functions and other estimates	For cattle and buffalo	Equations for sheep and goats
Maintenance (NE <sub>m</sub> )	C <sub>f</sub> x (Weight) <sup>0.75</sup>	C <sub>f</sub> x (Weight) <sup>0.75</sup>
Activity (NE <sub>a</sub> )	C <sub>a</sub> x NE <sub>m</sub>	C <sub>a</sub> x Weight
Growth (NE <sub>g</sub> )	22.02 x (BW/CxMW) <sup>0.75</sup> x WG <sup>1.097</sup>	[WG <sub>lamb</sub> x (a+0.5b(BW <sub>i</sub> +BW <sub>f</sub> ))]/365
Lactation (NE <sub>l</sub> )	Milk x (1.47+0.40 x fat)	Milk x EV <sub>milk</sub>
Attraction Power (NE <sub>work</sub> )	0.10 x NE <sub>m</sub> x hour	NA
Wool Production (NE <sub>wool</sub> )	NA	(EV <sub>wool</sub> x Pr <sub>wool</sub> )/365
Pregnancy (NE <sub>p</sub> )	C <sub>fertility</sub> x NE <sub>m</sub>	
Ratio of net energy available in the diet to digestible energy consumed (REM) for maintenance	[1.123-(4.092x10 <sup>-3</sup> xDE)+(1.126x10 <sup>-5</sup> x(DE) <sup>2</sup> )-(25.4/DE)]	
The ratio of net energy available for growth in a diet to digestible energy consumed (REG)	[1.164-(5.16x10 <sup>-3</sup> xDE)+(1.308x10 <sup>-5</sup> x(DE) <sup>2</sup> )-(37.4/DE)]	
Gross Energy (GE)	Equation 10.16	
Source: Cattle and buffalo equations based on NRC (1996) and sheep and goats based on AFRC (1993; 1995). NA: not valid		

**GROSS ENERGY equations for Cattle/Buffalo, Sheep and Goats:**

$$\left[ \frac{\left( \frac{NE_m + NE_a + NE_l + NE_{work} + NE_p}{REM} \right) + \left( \frac{NE_g + NE_{wool}}{REG} \right)}{DE} \right]$$

After calculating GE values, feed intake in daily dry matter units (DMI) (kg day<sup>-1</sup>) should also be calculated. To convert GE to dry matter intake (DMI), GE is divided by the energy density of the feed (NE<sub>mf</sub>). By default, there is a dry matter value of 18.45 MJ kg<sup>-1</sup>. Daily dry matter intake should be between 2% and 3% of the body weight of mature or growing animals. In high-producing dairy cows, intakes can provide up to 4% of body weight.

**3. Methane Conversion Factor (Y<sub>M</sub>)**

Y<sub>M</sub>: Reduction as a percentage of gross energy intake converted to methane. Traditional methods, respiratory calorimeters, head enclosures are used to measure Y<sub>M</sub> (Johnson and Johnson 1995). When specific Y<sub>M</sub> values for cattle and buffalo are not available, the values given in Table 5 are available.

**Proceeding Book of ISESER 2023**

**Table 5.** Cattle/Buffalo Methane Conversion Factors ( $Y_m$ )

<b>LIVESTOCK CATEGORY</b>	<b>DEFINITION</b>	<b>(DE%) AND NEUTRAL DETERGENT FIBER (NDF, %DMI)</b>	<b><math>Y_M</math></b>
*Dairy cattle and buffalo	Highly productive cows (> 8500 kg/head/year <sup>-1</sup> )	DE ≥ 70 NDF ≤ 35	5.7
	Highly productive cows (> 8500 kg/head/year <sup>-1</sup> )	DE ≥ 70 NDF ≥ 35	6.0
	Medium productive cows (5000 -8500 kg per year <sup>-1</sup> )	DE 63-70 NDF > 37	6.3
	Low productive cows (<5000 kg head year <sup>-1</sup> )	DE ≤ 62 NDF > 38	6.5
Non-dairy multi-purpose cattle and buffalo	> 75% feed	DE ≤ 62	7.0
	Rations with >75% high quality forage and/or mixed rations, 15 to 75% forage of the total ration and/or silage mixed at intervals.	DE 62-71	6.3
	Feedlot (all other reports, 0- 15% feed)	DE ≥ 72	4.0
	Feedlot (steam milky corn, ionophore property-0-10% feed)	DE > 75	3.0
* $Y_m$ is for dairy cattle. In their dry phase, for dairy cattle in high and medium production systems, a value of (6.3) should be selected as standard for non-dairy high-quality feed, and for low-production systems with >75% low-quality feed, a value of (7.0) should be selected.			

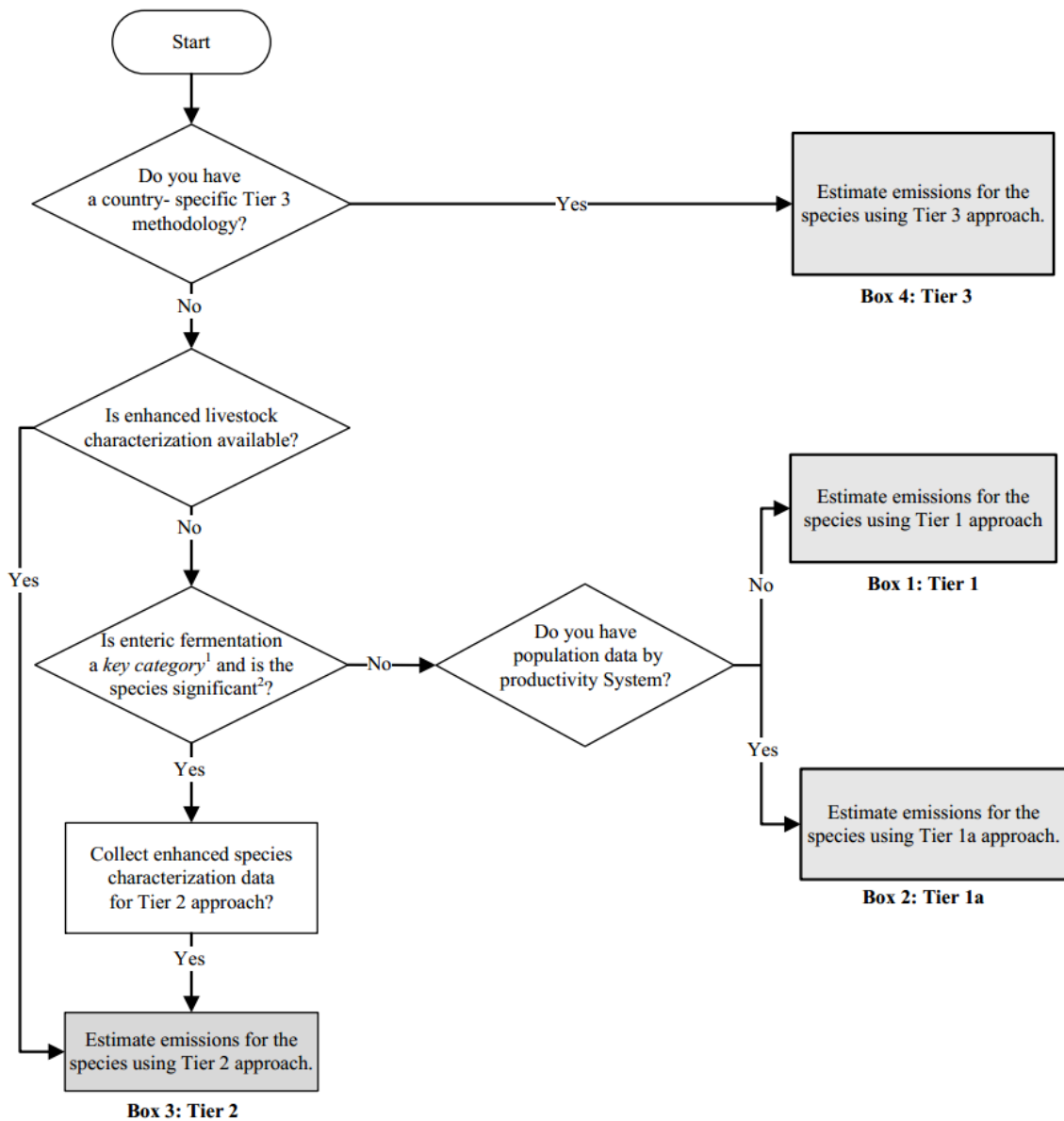

Figure 1. Enteric Fermentation Methane Emissions Decision Tree(IPCC Figure 10.2)

**Emission equation from enteric fermentation (Tier 1)**

$$E_T = \sum EF_{(T)} \times (N_{(T)} / 10^6)$$

$E_T$  = T animal's EF methane emissions, Gg CH<sub>4</sub> years<sup>-1</sup>  
 $EF_{(T)}$  = emission factor for defined livestock distribution T in kg CH<sub>4</sub> head<sup>-1</sup> year<sup>-1</sup>  
 $N_{(T)}$  = number of animal species/category heads  
 $T$  = livestock species/category

To estimate total emissions, selected emissions factors are multiplied by the relevant animal population.

**Total emission equation due to enteric fermentation (Tier 1)**

$$Total\ CH_4\ Enteric = \sum_{i,P} E_{i,P}$$

TotalCH<sub>4</sub> Enteric = Total methane emissions from Enteric Fermentation, Gg CH<sub>4</sub> years<sup>-1</sup>

Proceeding Book of ISESER 2023

$E_{iP}$  = emissions of animal categories and subcategories based on *i.th* production systems

**Tier 2 enteric fermentation emission factor equation:**

$$EF = \frac{GE \cdot \left( \frac{Y_m}{100} \right) \cdot 365}{55.65}$$

$EF$  = emission factor, kg CH<sub>4</sub> head<sup>-1</sup> year<sup>-1</sup>

$GE$  = gross energy intake, MJ per<sup>-1</sup> day<sup>-1</sup>

$E_m$  = methane conversion factor is the energy content of methane at 55.65 percent (mj/kg CH<sub>4</sub>) of the gross energy in the feed converted to methane.

**Methane Emissions from Fertilizer**

Tier 1 method is applied using IPCC default VS excretion factors, default typical animal mass, default CH<sub>4</sub> emission factors and default animal waste management systems (AWMS)

Tier 2 is based on country-specific rich solids estimates and surface impact of total CH<sub>4</sub> emissions during manure management systems (including manure treatments such as biogas production), disposal and storage. When manure is stored as a liquid or treatment permits (in lagoons, ponds, tanks or pits), it decomposes anaerobically and may contain significant amounts of CH<sub>4</sub>.

Animal Waste Management System (Manure Management Systems) data are collected by FAO for regions and countries and are presented in tables of average individual sections treated by different management systems (IPCC 2019).

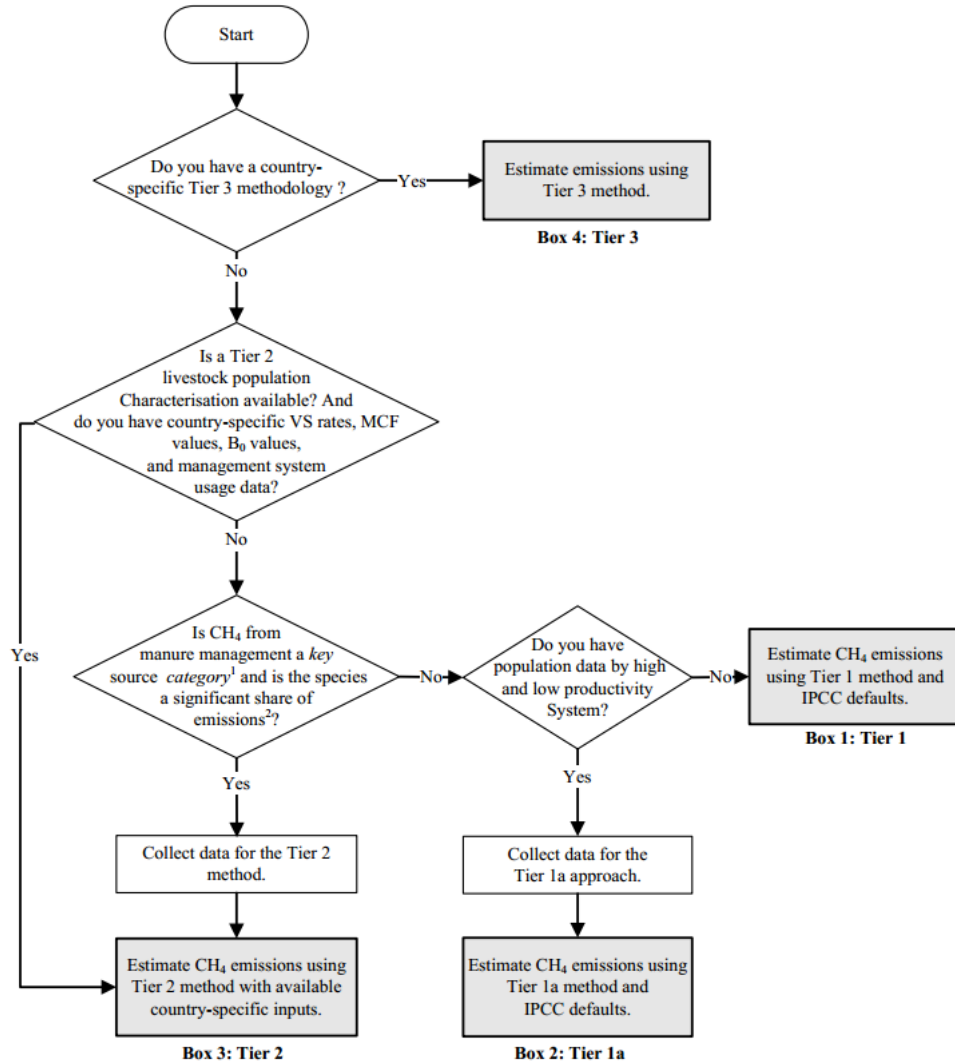

Figure 2. Methane Emissions from Fertilizer Decision Tree (IPCC Figure 10.3)

Equation for CH<sub>4</sub> emissions of fertilizers (Tier 1-Tier 1a):

$$CH_{4(mm)} = \left[ \sum_{T,S,P} \left( N_{(T,P)} \cdot VS_{(T,P)} \cdot AWMS_{(T,S,P)} \cdot EF_{T,S,P} \right) / 1000 \right]$$

$CH_4(mm)$  = CH<sub>4</sub> emissions contained in the fertilizer in the country, kg CH<sub>4</sub> year<sup>-1</sup>  
 $N(T, P)$  = Number of head of livestock species/category in the country  
 $VS(T, P)$  = Average annual VS excretion per Species/Category T as kg VS animal<sup>-1</sup> year<sup>-1</sup> when applicable for the P productivity system (calculated from Table 10.13a, Equation 10.22a)  
 $AWMS(T, S, P)$  = Total annual Vs fraction of manure for each livestock type/category T  
 $EF(T, S, P)$  = Emission factor for direct CH<sub>4</sub> emissions of animal manure management policies Species/Category T, Manure Management System S, Productivity System P, where applicable  
 $S$  = Manure management system  
 $T$  = Livestock species/category  
 $P$  = High Efficiency System or Low Efficiency System for Use in Advanced Level 1A - Taken from a simple Level 1 approach.

**Proceeding Book of ISESER 2023**

**2.3. Detailed calculation method (Tier 3)**

Although countries are encouraged to increase the amount of the Tier 2 method when data are available, complex analyzes are only discussed. The Tier 3 method is subject to extensive international evaluation, such as peer-reviewed publications, to ensure that predictions improve their accuracy and/or precision.

**Table 6.**Recommended Emission Inventory Methods for Enteric Fermentation

<b>farming</b>	<b>recommended emission regime methods</b>
Dairy Cattle	Tier 2 <sup>a</sup> / Tier 3
Other Cattle	Tier 2 <sup>a</sup> / Tier 3
Mandate	Tier 1/Tier 2
Sheep	Tier 1/Tier 2
Goat	Tier 1/Tier 2
Camels	Tier 1
Horses	Tier 1
Mules and Donkeys	Tier 1
Pig	Tier 1
Poultry	not developed
Other (e.g., Llamas, Alpacas, Deer, Ostrich)	Tier 1

<sup>a</sup>Tier 2 method is recommended for countries with large animal distribution. It may be desirable to improve the Tier 2 method for additional livestock subgroups when category emissions account for a large proportion of the total methane emissions for the country.

**3. CONCLUSION**

Developments in the world in recent years have shown how important it is to calculate carbon emissions. In order to reach more accurate results in calculating the carbon footprint, it would be more useful to support existing methods with on-site measurements in different countries. Therefore, new applied studies are needed on this subject.

**REFERENCES**

Aycaguer AC, Lev-On M, Winer A. Reducing Carbon Dioxide Emissions with Enhanced Oil Recovery Projects: A Life Cycle Assessment Approach, *EnergyFuels* 2001, 15, 2, 303–308, <https://doi.org/10.1021/ef000258a>

Cerri CC (2016), Moreira CS, Alves PA, et al. Assessing the carbon footprint of beef cattle in Brazil: A case study covering 22 farms in the state of Mato Grosso. *Cleaner Production Journal* 2016;112:2593-600.

FAO, IDF, IFCN (2014) World mapping of animal feeding systems in the dairy sector. Rome, Italy: Food and Agriculture Organization of the United Nations, International Dairy Federation, IFCN Dairy Research Network. pp. 160.

IPCC (2019) Refinement the 2006 IPCC Guidelines on National Greenhouse Gas Inventories, Chapter 10: Emissions from Livestock and Manure Management, 10.34

Johnson KA, Johnson DE (1995) Methane emissions from cattle. *Journal of Animal Sciences* 73: 2483-2492.



**Proceeding Book of ISESER 2023**

- Persson U.(2015) M, Johansson DJA, Cederberg C, Hedenus F, Bryngelsson D. Climate measurements and the carbon footprint of livestock products : where is the beef? *Environmental Research Letters* , Volume 10 , Issue 3 (10 034005) Available at: <https://iopscience.iop.org/article/10.1088/1748-9326/10/3/034005>
- Thornton PK 2010. Livestock production: recent trends, future prospects. *Philosophical Transactions of the Royal Society B* 365, 2853–2867
- Weidmann T, Minx J, 2008, A definition of ‘Carbon Footprint’. *Ecological Economics Research Trends*. New York, 1, 1-11

**O 31. INVESTIGATION OF MECHANIZATION LEVELS AND ENERGY EFFICIENCY OF  
DAIRY CATTLE FARMS IN EREĞLI DISTRICT OF KONYA PROVINCE**

Mehmet Zahid MALASLI<sup>1\*</sup>, Doğukan GAZAZ<sup>1</sup>

<sup>1</sup>*Department of Biosystems Engineering, Ereğli Faculty of Agriculture, Necmettin Erbakan University,  
Ereğli, Konya, Türkiye*

E-mail: [mzmalasli@erbakan.edu.tr](mailto:mzmalasli@erbakan.edu.tr), [gazaz\\_dogukan@outlook.com](mailto:gazaz_dogukan@outlook.com)

**ABSTRACT:** In this research, a survey was conducted in Konya Province Ereğli District for the mechanization level and energy management of dairy cattle businesses with at least 500 cattle, determined with the data received by the Ereğli District Directorate of Agriculture and Forestry. For this purpose, face-to-face surveys were conducted with 10 businesses. In the survey, to determine the level of mechanization; Information such as characteristics of operators and employees, general and structural characteristics of businesses, and mechanization features of businesses are included. In addition, the energy usage status of the enterprises and the potential of rooftop solar power for energy efficiency were determined with the PV SYST program.

According to the data obtained, it was determined that there were an average of 770 cattle in the businesses. While 40% of the businesses produce only animal products, 60% produce both plant and animal products. The average number of tractors in the enterprises is 5, the tractor age is 7 years, and the average tractor power is 63,4 kW. 80% of the tractors used in businesses are 4wd and 20% are 2wd. The total monthly electricity consumption of the businesses were calculated as 1,617,935 kW/month, and the annual electricity consumption were calculated as 16,942,801 kW/year. The average roof area where potential solar panels can be installed in businesses is 4230 m<sup>2</sup>. It has been determined that solar panels with a power of 1415 kWp can be installed in these areas.

*Keywords: Energy Efficiency, Dairy Cattle Farming, Ereğli, Mechanization Level, Solar Energy.*

**O 32. SUBSIDIZING AGRICULTURAL PRODUCTS TO PREVENT THEIR REPLACEMENT  
IN THE CASE OF CANNABIS LEGALIZATION – THE CASE OF ALBANIA**

Nives LAMÇE<sup>1\*</sup>, Besnik FETAI<sup>2</sup>, Aelita MANI<sup>3</sup>

*1. South East European University, Tetovo, North Macedonia*

*2. South East European University, Tetovo, North Macedonia*

*3. Luarasi University, Tirana, Albania*

E-mail: *nives.shtylla@gmail.com, b.fetai@seeu.edu.mk, mani\_alb@yahoo.com*

**ABSTRACT:** This paper aims to analyse if subsidizing agricultural products would minimize the replacement effect of these products with cannabis products. It describes the challenges that the agricultural sector is facing in many aspects, such as environmental issues, declining biodiversity, etc. Moreover, in the last decades, Albania has faced a growing number of illegal cultivations of cannabis in different parts of the country. A law approving and regulating the cultivation, production, and circulation in and outside of the country of cannabis for medical and industrial purposes has been approved this year by the Albanian Parliament. This law and the perspective of legalizing it in the later future also for recreative purposes, has raised not only pros but also cons in public opinion, such as related to the fear of shifting the business objective of farmers toward legal cannabis products. The primary data were collected through a questionnaire and analysed using a logit model with the help of Stata. The findings are of major use for the policymakers, researchers, and farmers, but also for society, as it touches not only a strategic sector like Agriculture but also a sensitive one, like narcotics and pharma business.

*Keywords: Agriculture, Subsidy, Cannabis, Legalization, Pharma*

## **1. INTRODUCTION**

The agricultural sector has faced many challenges during the last decades in Albania, from environmental changes due to climate change and pollution (Zhllima et al., 2022), declining biodiversity, labour force migration (Belletti & Leksinaj, 2016), and moving from the countryside to the cities (Caro, 2011), to other factors such as a lack of consistent and effectively managed state subventions for these products, etc. (Xama, 2017). Adding to these causes the introduction of other competitive products, such as cannabis, makes it even more difficult for this sector to remain profitable. Moreover, in the last decades, Albania has faced a growing number of illegal cultivations of cannabis in different parts of the country, the effect of which has been seen in many aspects of agriculture in Albania, monitored and reported by many such as Teqja et al., 2000; Kodderitzsch, 1999; Kurti & Alasani, 2021; Xama, 2017; Taylor, 2023; Jelsma et al., 2021; Han & Ng`ombe, 2023; Liperi, 2023, etc. which are further commented in the Literature review section below. The implications are not important only for the agricultural sector but also for the pharma sector, which will face a revolution given the importance that this plant has in modern medicine, deriving from a long tradition that cannabis has had in medicine over 200 years ago (Touw, 1981)) such as in the Ayurvedic pharmacopeia (Dwarakanath, 1965). All these implications, as well as its use in the industry, its social-related aspects, and others, make it a very important factor in the world`s sustainability (Raihan & Bijoy, 2023).

Therefore, the hypothesis of the study is as follows: H1: Subsidizing primary agricultural products decreases their replacement with cannabis products and by-products in case of cannabis legalization for medical and/or recreational purposes. The logit regression is applied in order to check validity of hypothesis. The contribution of the study is that to best of our knowledge, for the first time, we attempt to analyse the legalization of the cannabis in the economic context in the Republic of Albania. After the literature review, the methodology will describe the methods used to gain data and then analyse and interpret them. Afterwards the results and conclusions will follow.

## **2. LITERATURE REVIEW**

Albania has a long history of economic changes due to its transition from a centralized economy before the '90s to a free market after the regime changed into a pluralistic democracy. One of the sectors

**Proceeding Book of ISESER 2023**

that were dramatically affected by these changes was agriculture, which underwent a series of reforms from large-scale cooperatives to hundreds of thousands of family-operated farms in order to overcome the transitional problems in the agricultural system which were very crucial, such as related to the old production system, farm size, infrastructure, etc. (Teqja et al., 2000). Teqja et al. go on in their research by mentioning the lack of subventions in the policies regarding the development of agriculture and exports of foods, and the lack of import limitation as well as the scarce state involvement in this sector. During the first years of transition the Albanian agriculture faced an increase which was reflected in the agricultural GDP increase of 15 % more than in 1989, even though these levels stagnated in 1995 and on, still this sector remained the major contributor to the country's GDP during these years (55%-65%) (Kodderitzsch, 1999). Unfortunately, today agriculture counts only for 18.4 % of the GDP, despite the fact that it bears 36.4 % of the total employment (Directorate General for Agriculture and Rural Development., 2023). The EU Commission Report on Albania emphasizes some concerns about Albanian agriculture, such as the fact that the agricultural sector has faced high losses in the labor force which decreased by 5.3 %, and that the structure of the economy tends to be more oriented towards industry and services, moving away from agriculture (European Commission, 2022). But it goes on by describing also some positive aspects such as the progress made regarding the registration of farms and the enhancement of the capacity of the administration in favour of rural development. Another problem related to agriculture in Albania is the fact that 95 % of the farms are small mostly family farms, which lack modern skills on managing and new projects, know-how about good agriculture, and other standards such as safety (FAO, 2022). Other concerns regarding agriculture are shown also in other research such as in the study by Zhllima et al. on Agricultural land markets in transition in Albania, which discusses that the market of land sale even after decades of the implementation of Law 7501/1991 on Land continues being very fragile in the country, which impacts agriculture and the national and foreign financing schemes (Zhllima et al., 2021). Regarding grants in agriculture, worth mentioning have been the IPARD projects, like IPARD Like, IPARD II, the EU Commission has raised concerns regarding de-commitment risks due to project delays as well as about the low national budget for agriculture as IPARD should not be seen as a substitute to it (European Commission, 2022). Through the years there have been reports repeatedly on the failure of state subventions for agriculture and the related problems that farmers have to be competitive in an ever-changing market towards a technology-driven industry and service influenced by fast technological development and increased consumerism, as well as price issues in the light of neighbour countries being subsidized more efficiently and not being affected by any entry quota (Kurti & Alasani, 2021). The well-known economic Journal "Monitor" have raised this issue in 2017 about the problematics that this sector which had the most important role in the economic growth, was facing due also to the failed subvention scheme in Albania during those last three years (Xama, 2017). The World Bank Report of Fall 2023 published agricultural data about the 6 Western Balkan countries, according to which Albania held the last place regarding Agricultural budget support, namely only 0.19 % of its GDP (World Bank Group, 2023), despite the fact that this sector holds the highest weight in the Albanian GDP (19 %). The history of fundamental grants in the agricultural sector began with the IPARD Like in 2012, an instrument of the European Union for rural development in the phases before the accession to the European Union (Instrument of Pre-Accession for Rural Development) (SHGPAZ, n.d.). IPA which is the instrument for accession assistance includes the IPA rural development programs (IPARD) (EU Commission, n.d.). After the first phase of support was implemented IPARD II (2014-2020) and IPARD III (2021-2027) (Agricultural Rural Development Agency, n.d.). In 2023 was communicated a temporary suspension of the IPARD II agriculture programme in Albania due to suspicions of corruption regarding the package of 94.6 million euros grant (Amfora, n.d.). Attempts from media have been made to put light on this issue, such as the request for information made by the online media portal Amfora to the Agriculture Rural Development Agency and to the Commissioner for the Right to Information in Albania (Amfora, 2023). Some other media have reported on the matter, such as the economic journal Monitor which reports that IPARD II is under investigation by OLAF which has blocked the funds for Albania for an indefinite time (Hoxha, 2023). There is no official statement about these procedures, apart from a response from the Ministry of Agriculture and Rural Development acknowledging this suspension of funds from DG AGRI and committing to further implement the program (Ministry of Agriculture and Rural Development, 2023). Another serious media, Euractiv, has written about OLAF's investigation on Albanian IPARD II funds (Taylor, 2023). Even though findings are not yet public, the Euractiv source can be called trustworthy

**Proceeding Book of ISESER 2023**

because as a news website specializing in EU policies, this media has joined the Trust Project which shows its commitment to ethics and transparency (Euractiv, n.d.). According to the International Accounting Standards 20, sometimes grants are also called subventions (International Accounting Standards 20, n.d.), which explains the use of the term subventions in cases of governmental and other like funds to the private in Albania. In all the tumult of the agricultural transition history and the late cramp in which it is involved, adding another external factor such as another competitive product like cannabis would make the situation more difficult to handle with regard to farmers' perspective of investment. Albania is mentioned among the worldwide significant traditional sources of cannabis supply for international markets (Jelsma et al., 2021). Lately, a draft law has been approved by the Albanian Government for the legalization of medical cannabis, which has raised many pros and cons in public opinion. Despite its medical benefits for those affected by specific illnesses, and other economic or crime prevention aspects, it also bears a risk for the fragile Albanian agricultural landscape being dominated in the near future by the fast and lucrative business of opening a medical cannabis (or eventually recreative cannabis if it is legalized later on too) farm rather than investing in primary agricultural products (Monitor, 2023). The purpose of this paper is to analyse if subsidizing agricultural products would minimize the replacement effect of these products with cannabis products. There is evidence from other parts of the world that cannabis crop has been seen as an alternative to other crops, but in positive terms for eg. replacing soybean and wheat because of cannabis profitability, the fertility effect on soil, and its potential as an energy plant, etc. (Han & Ng'ombe, 2023). For many years in many countries such as Morocco, Afghanistan, Cambodia, Mexico, Pakistan, Thailand, etc., growing cannabis illegally has been an alternative for many poor households, therefore the legalization of cannabis for medical purposes could boost agricultural production in terms of raw material and industrial processing (Jelsma et al., 2021). This study ranks Albania next to these countries, as a significant and traditional source of cannabis supply in the world (id.). On the other side, implementing policies and different incentives for enterprises, especially the small and medium ones, would be very beneficial to rural areas to escape poverty towards the value chain (FAO, 2021). Before legalizing cannabis for cosmetic, industrial and medicinal purposes in Morocco in July 2021 (Mahyou, 2023) it was already thought about the importance of assisting farmers in substituting cannabis with other crops, even though it was very difficult to implement in the light of their long history of kif cultivation (Jelsma et al., 2021). Albania has taken the initiatives to learn the willingness of farmers to cultivate industrial hemp (National Albanian Hemp Industry Association, n.d.), while on the other side they still lack competitiveness in their primary products in comparison to neighbour countries such as North Macedonia where e.g. the wages in agriculture are higher (Liperi, 2023), winegrowers are subsidized for fertilizers, working process, etc., which after the CEFTA agreement between the Balkan Countries makes it harder for Albanian farmers to compete with lower prices of neighbour countries (Kurti, & Alasani, 2021). The lack of workers and cannabis greenhouses now after the legalization of cannabis for medical purposes threatens to further shrink the productive land area and the number of workers working in rural areas together with primary agricultural products (Monitor, 2023). There is scarce scientific literature supporting the hypothesis of this study, therefore it will serve as a good reference point for further research in Albania.

**3. METHODOLOGY**

For the purpose of this study, primary data were used. They were collected from a questionnaire spread to people of different age groups and professions through electronic communication means. As a usual practice in the nowadays digitalized society, the respondents were asked to possibly send their questionnaire to other adults and businesses that they deemed suitable to answer such questions (Mani, et al., 2022). Qualitative data derived from the asked questions about subventions and substituting primary agricultural products with cannabis for medical and/or recreative purposes, which were analyzed using STATA, an easy-to-use software for generating statistical analysis and graphics (Cleff, 2019). The short yes/no answers were coded to 1 and 0. For this reason a Logistical Regression analysis was conducted, as a suitable method for binary outcomes (Mehmetoglu & Jakobsen, 2016). The logistic regression model is as follows:

$$RA_{it} = B + B_{it} + \epsilon_{it} \tag{1}$$

**Proceeding Book of ISESER 2023**

Where RA is replacement of agricultural products with cannabis for individual  $i$  at time  $t$ ; vector  $B$  contains individual subsidize of agricultural products and  $\epsilon_{it}$  stochastic component.

The study has some limitations regarding data collection. One of them regards the hesitation to give a personal opinion on these issues, especially about the legalization of cannabis for recreational purposes and their potential to replace primary agricultural products. The lack of funding for scientific research in our country makes it more difficult to reach out to the farmers on site, as well as the lack of access to technology in deep rural areas. Moreover, the lack of scientific literature in Albania about cannabis as a legal crop that would replace agricultural products, and the poor literature about agriculture in general, makes it more difficult to include other components in the independent variable, in order to give more significant results.

**4. RESULTS AND DISCUSSIONS**

From the results the majority of the respondents were above 24 years old (51.9%), above 50 000 ALL in monthly income (61.1%) and an universitarian education, Bachelor Degree (31.5), Master (53.7%) and Ph.D. or up (11.1%). The majority was also in favor of cannabis legalization for medical purposes (70.4%), whether for recreational purposes were only 46.3 % of the respondents pro. Regarding the question whether or not the Albanian Government should subsidize more the primary agricultural products, 87 % responded with yes, and to the question regarding the possible replacement of these products in case of less subventions, 77.7 % were in favor.

With a number of 864 respondents, we got 864 observations, enough to make the following analysis as it derives from Tables 1 and 2 below.

**Table 1. Logit Model**

DepVReplaceAgriProdCann	Coeff.	Std. err.	z	P> z	[95% Conf. Interval]
IndVSubventAgriProd	.6161861	.2217878	2.78	0.005	.1814901 1.050882
_cons	-.9162907	.209165	-4.38	0.000	-1.326247 -.5063348

*Source: Authors Calculation*

The Logistic Regression analysis shows a P-value lower of 0.005, showing a high significance of the independent variable for the proposed hypothesis. With this result, the deviation from the null hypothesis is statistically significant and the latter can be rejected. It might be an unexpected result that the subvention of primary agricultural products does not decrease their replacement with cannabis crops. Nevertheless, there is a positive relationship between subvention for primary agricultural products and replacement with cannabis products. The result rejects the hypothesis that subsidizing primary agricultural products decrease their replacement with cannabis products and by-products in case of cannabis legalization for medical and/or recreational purposes.

**Table 2. Marginal effects**

variable	dy/dx	Std.err.	Z	P> z	[95% Conf. Interval]	x
IndVSubventAgriProd	.1398176	.04634	3.02	0.003	.048996 .230639	.87037

*Source: Authors Calculation*

Even Table 2 on marginal effects shows a low standard error and a P-value lower than 0.05, reinforcing the significance of the predictor. According to Table 2 on marginal effects, the result shows that subsidizing agricultural products by the Government of the Republic of Albania is likely to replace with cannabis products by 13%. Moreover, unless the government of the Republic of Albania subsidizes agricultural products, the legalization of cannabis is likely to replace agricultural products by 13%. In addition, after the legalization of cannabis products and subsidizing agriculture, the result shows that

## **Proceeding Book of ISESER 2023**

only 13% will be replaced with cannabis, whereas 87% of agriculture production will continue to produce traditional products. On the other hand, without subsidizing agricultural products, it is likely the figure to be increased much more than 13%. Since the legislation legalizing cannabis for medical and industrial purposes is very recent, the possible results are described as they will happen in the future, because the actual influence of this legalization cannot be measured yet for the moment.

## **5. CONCLUSIONS**

As seen above, besides subvention policies, there are many other factors influencing farmer's decision to engage in legal cannabis cultivation, such as worker's wages, inflation, fiscal packages, migration, the profitability of the cannabis sector, etc. But, as our predictor did show significance for the study, it means that after the legalization of cannabis, a much higher percentage of primary agricultural products would have been replaced with cannabis. Therefore, the Albanian economy needs to reconsider its policies regarding incentives to farmers to increase their agricultural production towards primary products and be competitive in a market full of cheaper goods from neighbour countries. Also, the previously mentioned limitations of the study, especially regarding the hesitation to answer questions about something that has been legal for a very short time (medical cannabis) and has not been legal yet (recreative cannabis), and the poor scientific literature because of which weren't included other factors in the equation, has to be taken into consideration. Moreover, the poor Albanian scientific literature on agriculture and specifically cannabis is also a weak point in the further development of this strategic sector, which needs a better support from academia and the scientific milieu. Further research should be done from academia and further attempts from the government and legislative organs should be undertaken to understand the needs, intents, and challenges of Albanian farmers regarding their productivity, profitability, and competitiveness at national and regional levels. All the efforts on a better implementation of the legislation regarding cannabis and the other areas being affected should go hand in hand with the Sustainable Development Goals (SDGs) of the United Nations in order for our country to better develop towards its inner necessities and the global trends.

## **REFERENCES**

- Agricultural Rural Development Agency, n.d. Retrieved from Internet on 2nd October: IPARD 2014 – 2020 – Skemat IPARD 2014 – 2020
- Belletti, M. & Leksinaj, E. (2016). The Impact of Migration on Albanian Agriculture: A Snapshot. Contributions to Economics, in: Anastasios Karasavvoglou & Zoran Arandjelović & Srđan Marinković & Persefoni Polychronidou (ed.), *The First Decade of Living with the Global Crisis*, edition 1, pages 47-58, Springer.
- Caro, E. (2011). From the village to the city: the adjustment process of internal migrants in Albania. [Thesis fully internal (DIV), *University of Groningen*]. [s.n.].
- Cleff, T. (2019)., *Applied Statistics and Multivariate Data Analysis for Business and Economics. A Modern Approach Using SPSS, Stata and Excel*. Switzerland: Springer International Publishing.
- Directorate General for Agriculture and Rural Development. (2023). Agri-Food Trade Statistical Factsheet. European Union – Albania. *European Commission*.
- Dwarakanath, C. (1965). Use of opium and cannabis in the traditional systems of medicine in India. *Bulletin on Narcotics*, Vol. 17(1): 15-19.
- Editorial Standards & Policies. (n.d.). EURACTIV. Editorial Standards & Policies – EURACTIV.com
- European Commission (EU Commission). (n.d.). Overview of EU pre-accession assistance for rural development (IPARD III). Retrieved on 14th October 2023 from [Overview \(europe.eu\)](https://europe.eu)
- European Commission. (2022). Commission Staff Working Document. Albania Report 2022 Accompanying the document Communication from the Commission to the European Parliament, the Council, the European Economic and Social Committee and the Committee of the Regions. 2022 Communication on EU Enlargement policy. Brussel, SWD(2022) 332 final.
- Food and Agriculture Organization of the United Nations (FAO). (2021). Sustainable Agribusiness and Food Value Chains. Retrieved on 1st September 2021 from [http:// www.fao.org/policy-support/policy-themes/ sustainable-agribusiness-food-value-chains/ en/#c452809](http://www.fao.org/policy-support/policy-themes/sustainable-agribusiness-food-value-chains/en/#c452809)
- Food and Agriculture Organization of the United Nations (FAO). (2022). Support the Development of Smallholders. *TCP/ALB/3703*.

**Proceeding Book of ISESER 2023**

- Han, J. & N'gombe, J.N. (2023). The relation between wheat, soybean, and hemp acreage: a Bayesian time series analysis. *Agricultural and Food Economics*, 11:1. <https://doi.org/10.1186/s40100-023-00242-1>
- Hoxha, B. (2023). Shqipëria, me financimet buxhetore më të ulëta për bujqësinë në Rajon dhe BE (Albania, with the lowest budget funding for agriculture in the Region and the EU). *Monitor*. Retrieved on 23rd October 2023 from: <https://www.monitor.al/shqiperia-me-financimet-buxhetore-me-te-uleta-per-bujqesine-ne-rajon-dhe-be/>
- Jelsma, M, Blickman, T., Kay, S., Martinez, N., Putri, D. (2021). A Sustainable Future for Cannabis Farmers “Alternative Development “ Opportunities in the Legal Cannabis Market. *Transnational Institute*.
- Kodderitzsch S. (1999). Reforms in Albanian Agriculture. Assessing a Sector in Transition. World Bank Technical Paper no. 431. Europe and Central Asia Environmentally and Socially Sustainable Rural Development Series.
- Kurti, I., Alasani, Sh. (2021). Industria e vreshtarisë “lulëzon” në Republikën e Maqedonisë së Veriut, Shqipëria në kufijtë e mbijetesës. *Faktoje*. Retrieved on 2nd September 2023 from <https://faktoje.al/industria-e-vreshtarise-lulezon-ne-republiken-e-maqedonise-se-veriut-shqiperia-ne-kufijte-e-mbijeteses/>
- Liperi, O. (2023). The lost race, why Albania has the lowest salaries in the region in IT, education, health, services, agriculture, finance and business. *Monitor*. Retrieved on 7th September 2023 from Gara e humbur, pse Shqipëria ka pagat më të ulëta në rajon në IT, arsim, shëndetësi, shërbime, bujqësi, financa e biznes - Revista Monitor
- Mahyou, S. (2023). ‘Outlaws’: Morocco’s Rif provides refuge for cannabis farmers. *Aljazeera*. Retrieved 4th August 2023 from <https://www.aljazeera.com/news/2023/7/28/outlaws-morocco-rif-provides-refuge-cannabis-farmers#:~:text=In%20July%202021%20in%20an,National%20Regulation%20Agency%20for%20Cannabis>
- Mani, A., Lamçe, N., Ulaj, G., Velgjini, J. (2022). Digitalization or nepotism in the recruitment process – the case of Albania. *Conference Proceedings. IMCERI 2022*. Luarasi University, Tirana.
- Mehmetoglu, M. & Jakobsen, T.G. (2016). *Applied Statistics using STATA A guide for the Social Sciences*. SAGE Publications Ltd.
- Mes kanabisit e bujqësisë (Among cannabis and agriculture). (2023, 30th June). *Monitor*. Mes kanabisit e bujqësisë - Revista Monitor
- Ministry of Agriculture and Rural Development. (2023). *Njoftim për Shtyp 19.07.2023 (Press Release 19.07.2023)*. [Njoftim për shtyp - Ministria e Bujqësisë dhe Zhvillimit Rural \(bujqesia.gov.al\)](https://www.mard.gov.al/njoftim-per-shtyp-19-07-2023)
- National Albanian Hemp Industry Association. (n.d.) Survey: Are you interested in farming industrial hemp in Albania? Retrieved on 15th October 2023 from <https://albaniahemp.org/anketat/shqiperi-kerpi-bujqesia/>
- Raihan, A. & Bijoy, T.R. (2023). A review of the industrial use and global sustainability of Cannabis. *Global Sustainability Research*. Vol. 2, No. 4. DOI: <https://doi.org/10.56556/gssr.v2i4.597>
- SHGPAZ. (n.d.). Programi IPARD (IPARD Program). Retrieved on 1st October, 2023 from [Programi IPARD \(shgpaz.al\)](https://www.shgpaz.al/)
- Standardi Ndërkombëtar i Kontabilitetit 20 – Kontabiliteti i Granteve Qeveritare dhe Dhënia e Informacioneve Shpjeguese për Ndihmën Qeveritare (International Accounting Standard 20 Accounting of Government Grants and Giving Explanatory Information for Governmental Help). (n.d.). *IASCF*.
- Taylor, A. (2023). OLAF concludes investigation into Albanian funds case, findings not yet public. *Euractiv*. Retrieved on 5th October 2023 from [OLAF concludes investigation into Albanian funds case, findings not yet public – EURACTIV.com](https://www.euractiv.com/en/olaf-concludes-investigation-into-albanian-funds-case-findings-not-yet-public/)
- The “Exclusive IPARD Club”: Who “farms” the EU funds in Albania and North Macedonia?! (15th August 2023). *Amfora*. Retrieved from: [The “Exclusive IPARD Club”: Who “farms” the EU funds in Albania and North Macedonia?! - Amfora](https://www.amfora.org/en/the-exclusive-ipard-club-who-farms-the-eu-funds-in-albania-and-north-macedonia-/)
- Touw, M. (1981). The Religious and Medicinal Uses of Cannabis in China, India and Tibet. *Journal of Psychoactive Drugs*, Vol. 13(1) Jan-Mar.
- Western Balkans Regular Economic Report No. 24. Fall 2023. Toward Sustainable Growth. (October 2023). *World Bank Group*.



**Proceeding Book of ISESER 2023**

- Xama, O. (2017). Dështon skema e subvencioneve në bujqësi (The agricultural subsidy scheme fails). *Monitor*. Retrieved on 4th September 2023 from <https://www.monitor.al/deshton-skema-e-subvencioneve-ne-bujqesi-2/>
- Zhllima, E., Imami, D., Nam, J., Shoshi, P. & Gjika, I. (2022). Awareness of climate change impact and adaptation in agriculture – the case of Albania. *European Countryside*, Vol. 4, No. 4, p. 604-622.
- Zhllima, E., Rama, K. & Imami, D. (2021). Agriculture land markets in transition – The inherited challenge of the post-communist land reform in Albania. *Land Use Policy*, 107.

**O 33. STRUCTURAL ANALYSE of GREENHOUSE SHEEP BARN for SHEEP BREEDING in KONYA#**

Selda UZAL SEYFİ<sup>1\*</sup>, Arif KARAKAYA<sup>1</sup>

<sup>1\*</sup>*Selçuk University, Agricultural Faculty, Farm Structure and Irrigation Department, 42021, Türkiye*

E-mail: *seldauzal@selcuk.edu.tr, arif.karakaya@konya.bel.tr*

**ABSTRACT:** Development of alternative barns designs; It has a very important place in terms of ensuring animal welfare and increasing efficiency and quality in animal production. Greenhouse sheep barns have become more preferred in recent years due to their ease of installation and economy, as well as animal welfare. Konya Region has an important place in sheep breeding in Türkiye. This study was conducted in Konya between 2022 and 2023 to examine the structural features of Greenhouse sheep barns, which have found widespread use in recent years. In the research, 25 Greenhouse sheep barns with different features suitable for the research purpose, built in the Konya Region with the support of the KOP administration (KOP Regional Development Administration, Ministry of Development), were examined. Purposive sampling method was used in the selection of the barns examined in the research. The structural adequacy and animal welfare suitability of the examined greenhouse sheep barns were investigated. In the study, it was determined that all of the barns were of steel construction and a four-layer membrane (air-permeable polyevins lining, moisture-absorbing isofelt felt, foil-coated bisofol with air bubbles in the middle, polyester-coated outer tarpaulin) cover was used. It was determined that the average floor area of the greenhouse sheep barns examined was 206 m<sup>2</sup> and the average animal population was 161. It was determined that the stocking density in the sheep barns was 1.28 m<sup>2</sup>/animal. The ratio of the total area of ventilation windows to the floor area is on average 2.1%. It was determined that gates with a width of 2.4 m and a length of 2.9 m were used in the sheep barns examined. User satisfaction in the farms has been determined to be 88% due to features such as greenhouse sheep barns, speed of construction and ease of transport. It was determined that the reason why problems were experienced in 12% of the examined farms was due to the high frequency of stocking in the barn and the inadequate use of ventilation openings.

*Keywords: Greenhouse sheep barn, Average settlement density, Four-layer membrane*

## **1. INTRODUCTION**

Konya is one of the provinces located in the Central Anatolia Region and has a say in Türkiye's agricultural production. Small livestock farming is a breeding method suitable for the climatic conditions of the region. The main aim of sheep farms is to increase the number of healthy lambs per parent sheep by minimizing losses. The main source of income for sheep breeders in our country is butchery and breeding lamb sales (Anonymous, 2019a). Factors such as the fact that natural resources, especially meadows and pastures, are more suitable for sheep and goats, and people's nutritional habits, lead to small animal breeding (Kaymakçı and Sönmez, 1996). Animals spread on pastures and pastures for 7-8 months of the year. In other months when the climate is harsh, they are taken to sheep barns. In addition to conventional sheep barns, greenhouse sheep barns are also used as barn. Due to the anatomical and physiological characteristics of sheep and their ability to adapt to climatic conditions, expectations for the development of alternative barns that are cheap, facilitate production conditions and meet the demands of the sheep are increasing. In line with these expectations, plastic-covered greenhouse-type barns have been developed (Onuk, 2015).

This research was carried out in order to determine the structural characteristics of greenhouse sheep barn livestock farming farms in the central districts of Konya Province, to identify their competence status, problems and to develop solution suggestions. In addition, the study tried to determine the animal welfare and structural adequacy of greenhouse sheep barns built in the Konya Region, especially with the support of KOP (Konya Plain Project Regional Development Administration).

## Proceeding Book of ISESER 2023

### 2. MATERIAL AND METHOD

This research was conducted in 25 greenhouse sheep barns in sheep farming farms located in the central districts of Konya Province in 2022-2023. Purposive sampling method was used to determine the sheep farming farms examined. 25 greenhouse sheep farming farms with different capacities and different structural features, which are representative of the Konya Region, were selected as research material.

Research; The study was carried out in three stages: identification of the farms, determination of the characteristics of the farm and the characteristics of the structures and facilities in the farm through field work, and evaluation of the study results.

In the first stage, experts working in official organizations in the region (District Directorates of Agriculture, KOP) were interviewed and an inventory of greenhouse sheep barns was prepared. Among these farms, farm that could represent the region with different characteristics in terms of planning principles suitable for the purpose of the research were determined. Of the 25 farms examined in the study, 13 are located in Meram District, 8 in Karatay District and 4 in Selçuklu District. In the second stage of the study; farm characteristics (location of the farm, establishment date, farm capacity, land availability...), sheep barns features (barn type, planning system, barn capacity, barn dimensions, structural features, material features...) and manure management (manure removal method, mechanization used). Information regarding the situation...) was obtained. The information contained in the surveys prepared for this purpose; The data were obtained through face-to-face interviews, measurement, observation and photography by visiting farms.

In the research, the data obtained from the field studies were classified and in the light of literature reports (Olgun, 2011; Okuroğlu and Yağanoğlu, 1998; Uzal and Aslan, 2015; Uzal and Karaçay, 2017; Kaymakçı and Sönmez, 1996; Ekmekyapar, 1997; Balaban and Şen, 1988). has been evaluated. Sheep farming farms, greenhouse sheep barns and the structures and facilities in the farm were evaluated in terms of animal welfare and planning principles.

### 3. CONCLUSION AND DISCUSSION

#### 3.1. General Features of Greenhouse Sheep Farms

The distribution of greenhouse sheep farming farms examined in the research according to the central districts of Konya is given in Table 3A. 52% of the examined farms are located in Meram, 32% in Karatay and 16% in Selçuklu district. Since there are more farms in Meram District, more than 50% of the farms examined in the research were selected from Meram District.

**Table 3.A** Distribution of Greenhouse Type Sheep Farms Examined in the Research by Districts

District Name	Number of Farm	% Percentage
Karatay	8	32,0%
Meram	13	52,0%
Selçuklu	4	16,0%
<b>Total</b>	<b>25</b>	<b>100,0%</b>

The distribution of greenhouse sheep farms examined in the study according to their distance from the settlement is given in Table 3.B. The distances of the examined farms to the settlement center vary between 50-4,500 m, and it was determined that 44% of the farms were less than 1000 m to the settlement center. The sheepfold location should be at least 1 km away from residential areas, protected from winter winds, exposed to constant sunlight and close to pasture (Olgun and Çelik, 1999). It was determined that 56% of the farms examined in the research were more than 1 km away from the settlement center, and their locations are shown on the map in Figure 3.A.

**Proceeding Book of ISESER 2023**

**Table 3.B** Distribution of Greenhouse Type Sheep Farms Examined in the Research According to Their Distance from Settlements

Distance to Settlement (m)	Number of Farm	% Percentage
< 1000	11	44,0%
1.000- 2.000	10	40,0%
2.001- 3.000	3	12,0%
3.001- 4.000	0	0,0%
> 4.001	1	4,0%
<b>Total</b>	<b>25</b>	<b>100,0%</b>



**Figure 3.A** Locations of Greenhouse Sheep Farms Examined in the Research

Most of the greenhouse sheep barn farms examined in the research were built in 2019. The increase in greenhouse sheep barn farms over time can be seen in Table 3.C.

**Table 3.C** Distribution of Greenhouse Sheep Farms Examined in the Research According to the Year of Construction

Year of Construction	Number of Farm	% Percentage
2017	1	4,0%
2018	2	8,0%
2019	16	64,0%
2020	6	24,0%
<b>Total</b>	<b>25</b>	<b>100,0%</b>

The land ownership status of the greenhouse sheep barns examined in the research was examined and it was understood that 64% of the land was privately owned. The examined farm number 11 was established in a place not registered in the land registry. The distribution is given in Table 3.D.

**Proceeding Book of ISESER 2023**

**Table 3.D** Distribution of Greenhouse Sheep Farms Examined in the Research According to Land Ownership Status

Land Ownership Status	Number of Farm	% Percentage
State Land Rent	3	12,0%
Pasture	5	20,0%
Privately owned	16	64,0%
Non-Registered Place	1	4,0%
<b>Total</b>	<b>25</b>	<b>100,0%</b>

In 20% of the greenhouse sheep farming farms examined in the research, no cultivation is carried out for feed production purposes, and feed is purchased entirely from outside. The distribution of farms according to their cultivation status is given in Table 3.E. Planting for animal feeding is very important for the continuity of farm.

**Table 3.E** Land Cultivation Status of Greenhouse Type Sheep Farms Examined in the Research

Area Cultivated for Feed per Animal (da/animal)	Number of Farm	% Percentage
-	5	20,0%
< 0.2	11	44,0%
0.2-0.4	8	32,0%
> 0.4	1	4,0%
<b>Total</b>	<b>25</b>	<b>100,0%</b>

### 3.2. Features of Greenhouse Sheep Barns

The lengths of the greenhouse sheep barns examined in the research are planned to be multiples of 2 m, since the distance between the two trusses is 2 m. Depending on the number of animals, the length of the sheepfold can be increased or decreased as desired.

**Table 3.F** Distribution of Greenhouse Sheep Barns Examined in the Research According to Their Lengths

Length of Greenhouse Sheep Barn (m)	Number of Barns	% Percentage
16	3	12,0%
18	4	16,0%
24	4	16,0%
30	8	32,0%
34	6	24,0%
<b>Total</b>	<b>25</b>	<b>100,0%</b>

The width of the greenhouse sheep barns examined in the research was measured as 8 m in all of them. Since all the barns were built by the same administration, they were built to a standard size.

**Proceeding Book of ISESER 2023**

**Table 3.G** Distribution of Greenhouse Sheep Barns Examined in the Research According to Their Widths

<b>Width of Greenhouse Sheep Barn (m)</b>	<b>Number of Barns</b>	<b>% Percentage</b>
< 9.00	25	100,0%
9.00-12.00	0	100,0%
> 12.00	0	100,0%
<b>Total</b>	<b>25</b>	<b>100,0%</b>

The width of sheep barns generally varies between 9-12 meters (Olgun, M. 2011). In the light of these data, it was seen that the widths of the sheep barns were close to the limits of the literature information.

The floor area of greenhouse sheep barns and the animal stocking density determined according to the number of animals are important criteria in terms of animal welfare. The in-barn stocking frequency of the greenhouse sheep barns examined in the research is classified according to Olgun (2011) and is given in Table 3.H.

**Table 3.H** Distribution of Greenhouse Sheep Barns Examined in the Research According to the Density of Stocking in the Barns

<b>Density of Stocking in the Barns (m<sup>2</sup>/animal)</b>	<b>Number of Barns</b>	<b>% Percentage</b>
<0.80	0	0,0%
0.81-1.20	11	44,0%
1.21-1.50	4	16,0%
1.51-1.80	6	24,0%
>1.80	4	16,0%
<b>Total</b>	<b>25</b>	<b>100,0%</b>

According to Olgun (2011), 0.80-1.20 m<sup>2</sup> of resting area is required for sheep, 1.20-1.50 m<sup>2</sup> for sheep with one lamb, and 1.50-1.80 m<sup>2</sup> for sheep with two lambs. Koçak (2020) in his study measured 2.00 animals per m<sup>2</sup> in cattle farms and 1.47 animals per m<sup>2</sup> in sheep farms. According to Anonymous (2019a), planning should be done so that the floor area in the barns is 2 m<sup>2</sup> per adult sheep, 1.4 m<sup>2</sup> per yearling (6-12 months old) and 0.7 m<sup>2</sup> per lamb. It was understood that in 44% of the greenhouse sheep barns examined, the density of in-barn stocking was below the average value, and in 40% it was above the average value. In terms of animal welfare, the density of stocking can be reached to average values by reducing the number of animals in these barns or increasing the length of the barn.

The greenhouse sheep barns examined in the research were built with a Gothic roof system. The ridge height in the greenhouse sheep barns examined was 3.90 m; The side wall height decreases to 1.60 m.

**Table 3.I** Distribution of Greenhouse Sheep Barns Examined in the Research According to Ridge Heights

<b>Ridge Height (m)</b>	<b>Number of Barns</b>	<b>% Percentage</b>
2.40-2.50	0	0,0%
2.51-2.75	0	0,0%
2.76-3.00	0	0,0%
>3.01	25	100,0%
<b>Total</b>	<b>25</b>	<b>84,0%</b>

**Table 3.J** Distribution of Greenhouse Sheep Barns Examined in the Study According to Side Wall Heights

Side Wall Height (m)	Number of Barns	% Percentage
<1.20	0	0,0%
1.21-2.00	25	100,0%
>2.00	0	0,0%
<b>Toplam</b>	<b>25</b>	<b>100,0%</b>

In closed barns, the height between the top level of manure and the ceiling or roof beam should not be less than 185-100 cm. In closed barns, the barn height can be 2.40–2.50 m in cold regions, 2.5–2.75 m in warm regions, and 2.75–3 m in hot regions (Yüksel and Şişman 2003). The height of sheep barns should not be less than 200 cm between the upper manure level and the lower roof beam. In cold regions, it may be between 240-250 cm, in warm regions between 250-275 cm, and in hot regions between 275-300 cm. In barns where the number of animals is high, it is made over 300 cm and can go up to 400 cm (Olgun, 2011). The height of the sheep barns is compatible with the values given for the cold region in the literature. The values given in the literature are for masonry type barns and are expected to be higher for greenhouse type barns. The higher the ridge, the higher the volume inside the barn.

In agricultural buildings, doors are made single-winged, double-winged or sliding, depending on their functions. The wing widths of single or double-winged doors are generally 90–100 cm and their height is 190–200 cm. These can be opened inwards or outwards depending on the situation (Ekmekyapar 1997). There are 2 gates in all of the barns examined; They are 2.90 m long and 2.40 m wide double-winged doors opening outwards. It is built in dimensions suitable for tractor and equipment entry into the sheepfold.

The number of windows in the greenhouse sheep barns examined in the research is between 6 and 16, and they are 45x55 cm or 45x90 cm in size. The windows are 1.2 m above the ground. The floor area ratio of the total area of the window is below 1%.

**Table 3.K** Distribution of Window Area According to the Ratio of the Floor Area in the Greenhouse Sheep Barns Examined in the Research

Ratio of Window Area to Floor Area	Number of Barns	% Percentage
< 0.010	25	100,0%
0.01-0.015	0	0,0%
> 0.015	0	0,0%
<b>Total</b>	<b>25</b>	<b>100,0%</b>

According to Anonymous (2019a), windows; although its area varies depending on the region, it should be 10-15% of the floor area and allow plenty of light. Air drafts that occur in the barn cause stress in the animals as they will suddenly lower their body temperature. The height of the windows from the floor is required to be between 1.20 and 1.70 m in animal barns (Ekmekyapar, 1997). In the greenhouse barns examined, the ratio of window area to floor area was found to be below the literature information. The height of the windows from the ground is lower. Since the floor area ratio of the total window area does not reach 10% in any farm, adequate light penetration cannot be provided. The height of the windows from the ground is 30 cm higher, which will reduce the risk of animals being caught in drafts.

In the greenhouse sheep barns examined in the research, the ventilation chimney consists of a 30 cm diameter and 50 cm long cylindrical pipe in the middle of the roof. There are a number of ventilation chimneys ranging from 8 to 16. The effective ventilation chimney height, that is, the top of the ventilation chimney, is 4.30 m above the ground. The ratios of the ventilation chimney area to the floor area in the greenhouse sheep barns examined in the research are classified and shown in Table 3.L.

**Table 3.L** Distribution of Ventilation Chimney Area According to the Ratio of the Floor Area in the Greenhouse Sheep Barns Examined in the Research

Ventilation Chimney Area to Floor Area (%)	Number of Barns	% Percentage
< 0.50	21	84,00%
>0.50	4	16,00%
<b>Total</b>	<b>25</b>	<b>100,00%</b>

Şişman et al (2009), ventilation chimney cross-sectional area should be at least 0.25 m<sup>2</sup> and maximum 1.00 m<sup>2</sup>, 0.50 m<sup>2</sup> ventilation chimney should be calculated for every 100 m<sup>2</sup> floor area, effective ventilation chimney height should be greater than 4.0 m. According to Anonymous (2019a), ventilation chimneys should be raised at least 50 cm above the roof ridge to ensure adequate ventilation in the barn. For natural ventilation, the ventilation chimney area should be 1.0-2.0 cm<sup>2</sup> for 1 m<sup>2</sup> of barn floor area. 84% of the barns examined It has been observed that the ratio of the area of the ventilation chimney to the floor area explained by Şişman et al (2009) is below the ratio. The number of ventilation chimneys and cross-sectional area should be increased. The effective ventilation chimney height is above the specified value.

The part of a building that remains below the ground surface and forms its infrastructure is called the foundation. It is the structural element that collects, carries and transmits the dead and live loads of the foundation structure to the ground (Yüksel and Şişman 2003). According to Anonymous (2019a), the portable barn skeleton section is made with a scissor system. The main carriers are fixed to the concrete floor with steel dowels.

In the greenhouse sheep barns examined in the research, except for farm no. 7, carrier elements were placed under the leveled ground in the excavated place at a height of 25-30 cm and filled with soil and fixed to the ground. Since the wind load was high in farm no. 7, a continuous concrete foundation of 30 cm width and 50 cm height was built on both sides along the sheepfold and the carrier element was connected to this foundation.

One of the most expensive building elements in the sheepfold to build and maintain is the roof. The roof protects the structure against external factors such as snow, rain and wind and also provides an aesthetic appearance to the structure (Ekmekyapar 1997). Covering material is one of the most important building materials of greenhouse sheep barns. In the greenhouse sheep barns examined in the research, there are 4 layers of material: air permeable polyevins lining on the first floor, isofelt felt with moisture absorption feature on the second layer, bisofol with foil on both sides and air bubble in the middle on the third layer, and polyester coated outer tarpaulin on the fourth layer. Deformation was observed in the cover material in farm no. 13 among the barns; No significant deformation was observed in the cover material in the other barns.

In the greenhouse sheep barns examined in the research, the average feeder length per barn was 28.4 m; The feeder length per animal was found to be 0.20 m/animal. The barns were classified by calculating the feeder lengths per animal for each barn and are given in Table 3.M.

**Table 3.M** Distribution of Greenhouse Sheep Barns Examined in the Study According to Feeding Lengths

Feeding Lengths (m/animal)	Number of Farm	% Percentage
< 0.20	15	60,00%
0.20-0.30	6	24,00%
0.31-0.45	4	16,00%
>0.45	0	0,00%
<b>Total</b>	<b>25</b>	<b>100,0%</b>



**Proceeding Book of ISESER 2023**

Required feeding length for each animal in feedlots; It is between 20-30 cm for lambs and 30-45 cm for sheep (Olgun, 2011). Required feeding length for each animal in feedlots; It is calculated as 18 cm for suckling lambs, 20 cm for weaned lambs, 30 cm for one-year-old lambs, 35-45 cm for ewes, 60 cm for those in the birth barns and 80 cm for breeding rams (Alkan 1972). According to Anonymous (2019a), the feeding length should be 40-50 cm per sheep and 20-30 cm per lamb. It was understood that the feeding length of the barns examined was below the range determined for sheep in 60% of the barns, as stated by Olgun (2011). Animals getting stuck in feeders while eating and feeding will reduce animal welfare and increase competition.

Of the greenhouse sheep barns examined in the research, 15 have waterers and 10 do not.

**Table 3.N** Distribution of Water Supply Types in the Greenhouse Sheep Barns Examined in the Research

Water Supply Types	Number of Farm	% Percentage
Fountain	9	36,0%
Well	8	32,0%
Water network	7	28,0%
Water Network+Well	1	4,0%
<b>Total</b>	<b>25</b>	<b>100,0%</b>

If the water needs of the sheep will be met in the barn, it is most appropriate to use automatic waterers. Automatic waterers are arranged as one for 40-50 sheep (Balaban and Şen, 1988). In 15 barns with drinkers, a value of 0.02 m drinker/animal was reached.

Artificial lighting in the greenhouse sheep barns examined in the research is provided by lamps and projectors connected to the electrical network, solar powered projectors and flashlights.

**Table 3.O** Distribution of Lighting Types in the Greenhouse Sheep Barns Examined in the Research

Lighting Type	Number of Farm	% Percentage
Lamps and projectors	12	48,0%
Solar powered projectors	1	4,0%
Flashlights	12	48,0%
<b>Total</b>	<b>25</b>	<b>100,0%</b>

13 of the greenhouse sheep barns examined in the research are illuminated by one or more lamps from the nearby line or from the solar energy panel. In the other 12 sheepfolds, the need for illumination at night is provided by flashlights. It has been understood that in sheepfolds where natural lighting is insufficient due to the small window area, it should be supplemented with artificial lighting.

### **3.3. Manure Management in the Farms Examined in the Research**

Manure management of the greenhouse sheep barns examined in the research is done with a scraper attached to the back of the tractor or by manually throwing it into the tractor trailer entering the barn.

**Table 3.P** Manure Management in Greenhouse Sheep Barns Examined in the Research

Cleaning method	Number of Farm	Frequency (month <sup>-1</sup> )	% Percentage
Manually throwing it into the tractor trailer	7	0.33	28,0%
Manually throwing it into the tractor trailer	6	0.66	24,0%
Manually throwing it into the tractor trailer	4	1	16,0%
With scraper mounted on tractor	8	1	32,0%
<b>Total</b>	<b>25</b>	<b>0.73</b>	<b>100,0%</b>

Anonymous (2019a) manure yards; although it varies depending on the productivity period, sheep produce 4-5% of their average live weight per kg of wet manure per day. Manures that serve as a breeding ground for lice, fleas and houseflies should be kept away from the barns. In 32% of the barns examined, manure cleaning is carried out once a month because stripping with a tractor is easier, while in 68%, manual loading onto the tractor trailer is done less frequently because it requires manpower.

As a result, user satisfaction in the greenhouse sheep barn sheep farming farms examined in the research is at the level of 88%. The problem of sweating inside the barn in winter was expressed as dissatisfaction in farms 11 and 13; it was observed that a part of the barn was reserved as a feed store and the ventilation openings there were closed. It was understood that the problems experienced in 2 farms were due to the high density of placement in the barn and the inadequate use of ventilation openings. The reason why the frequency of barn placement in the farm numbered 11 was lower is that the operator reduced the number of animals after the problems he experience.

The frequency of in-barn placement, which is low in 44% of the greenhouse sheep barns examined in the research, should be increased. The dimensions of the doors are planned appropriately in terms of mechanization and allow easy entry and exit to the sheepfold. Since the window area of all barns is below average values, natural lighting cannot be provided adequately. It is recommended to increase the number and area of windows and use more artificial lighting. It has been observed that it would be more appropriate in terms of planning to increase the number and cross-sectional area of ventilation chimneys in barns where the ratio of ventilation area to floor area is below the average. The effective ventilation chimney height is planned appropriately. In order to be economical, it is recommended to build a foundation, especially in regions where the wind speed is high, as not building a foundation structure increases the risk of the sheepfold tipping over against the wind load. The covering material is a well-chosen material, especially in terms of protection from excessive sun and heat insulation. Since in 60% of the barns, the length of the feeder per animal is below the feeder length range determined for the sheep, it is thought that if the number of feeders is increased so that the animals can be more comfortable while feeding, the welfare level will increase. Delayed cleaning of manure prevents lice, fleas, etc. It would be appropriate to clean manure more frequently, as pests cause discomfort and diseases to animals and employees. It has been understood that if the feed tanks must be inside the barn in the farms, it is necessary to separate the animals from where they are located so that they cannot reach the tanks. Otherwise, it is thought that the animals may die as a result of overeating. Electrical energy is drawn from the grid in most farms; It is recommended to develop more applications to benefit from natural resources, especially solar energy, for efficient use of energy.

## REFERENCES

- Alkan, Z. 1972. Ağılların Planlanması. Atatürk Üniversitesi, Ziraat Fakültesi Yayınları, Yayın No: 245.Araştırma No: 71, Erzurum, 103s
- Anonim, 2019-a. <https://www.tarimorman.gov.tr/HAYGEM> (Erişim Tarihi: 08/03/2022, 17:30)
- Anonim, 2019-b. Millî Eğitim Bakanlığı Hayvan Yetiştiriciliği Ve Sağlığı Koyun Ve Keçi Besleme Ders Kitabı Ankara, 2019.

**Proceeding Book of ISESER 2023**

- Balaban, A. ve E. Şen, 1988. Tarımsal Yapılar, Ankara Üniversitesi, Ziraat Fakültesi, Yayın No: 845,n244 s.
- Ekmeçyapar, T. 1997. Tarımsal inşaat, Atatürk Üniversitesi, Ziraat Fakültesi, Yayın No: 151, Erzurum, 197 s.
- Kaymakçı, M ve Sönmez, R. 1996. İleri koyun Yetiştiriciliği. Ege Üniversitesi Basımevi, Bornova, İzmir.
- Koçak, D. 2020. Ankara İli Polatlı İlçesi Küçük Ve Büyükbaş Hayvancılık İşletmelerinin Barındırma Sistemlerinin Hayvan Refahi Bakımından Değerlendirilmesi Yüksek Lisans Tezi, Kırıkkale, 44 s.
- Okuroğlu, M. ve Yağanoğlu, V.A., 1998.Kültürteknik. Atatürk Üniversitesi Ziraat Fakültesi, Yayın no: 336, Erzurum. 303 s.
- Olgun, M., Çelik, M. Y. 1999. Koyun Ağılları ve Ülkemizde Karşılaşılan Sorunlar. Türk-Koop Ekin Dergisi, 10: 62-69.
- Olgun, M. 2011. Tarımsal Yapılar, Ankara Üniversitesi, Ziraat Fakültesi, Yayın No: 244, 204 s.
- Onuk, A. 2015. İklim Denetimli Sera Tipi Koyun-Keçi Barınaklarının Bursa Bölgesinde Uygulanma Olanakları Yüksek Lisans Tezi, Bursa, 3 s.
- Şişman, C.B., Yılmaz, F., Gezer, E. 2009. Bolu yöresindeki küçükbaş hayvan barınaklarının yapısal durumu ve geliştirme olanakları. Tekirdağ Ziraat Fakültesi Dergisi, 6(2): 179-189.
- Uzal, S. ve Aslan, H. 2015. Alternative barn design applicable in different environmental condition for goat breeding. Journal of International Environmental Application and Science, Cilt: 10, Sayı: 4, 421-428 s.
- Uzal, S. ve Karaçay, M. 2017. Diagonal dairy goat barn design offering alternative area usage for different seasons in dairy goat breeding. Anadolu Tarım Bilimleri Dergisi, Cilt: 32, Sayı: 3, 340-349 s.
- Yüksel, A.N. ve Şişman, C.B. 2003. Tarımsal İnşaat, T.Ü. Tekirdağ Ziraat Fakültesi, Yayın No: 36

**O 34. URBAN WASTEWATER TREATMENT PLANT EFFICIENCY MODELING WITH  
ARTIFICIAL NEURAL NETWORK: KONYA EXAMPLE**

Ülkü SERTKAN AYDIN<sup>1</sup>, Gamze SÖNMEZ<sup>2</sup>

<sup>1</sup>*Provincial Directorate of Environment, Urbanization and Climate Change, Konya, Türkiye*

<sup>2</sup>*Aksaray University, Faculty of Engineering, Department of Environmental Engineering, Aksaray,  
Türkiye*

E-mail: [ulku.aydin@csb.gov.tr](mailto:ulku.aydin@csb.gov.tr)(1) [gamzesonmez@aksaray.edu.tr](mailto:gamzesonmez@aksaray.edu.tr) (2)

**ABSTRACT:** With the climate crisis, the need to use our natural resources effectively and efficiently has begun to be discussed on the world agenda. The reality of drought that we are facing in this process has also brought to the agenda the development of appropriate technologies for the reuse of wastewater. In this context, it is important to control the process management of existing wastewater treatment plants, reduce the potential effects of wastewater treatment plant effluent on the receiving environment and make it reusable. With developing computer technologies, the use of artificial intelligence techniques has increased. Artificial neural networks are also included among these techniques. Studies are being carried out to predict the performance of urban wastewater treatment plants using methods such as artificial neural networks. In our study, it was aimed to estimate the values of Konya Urban Wastewater Treatment Plant effluent parameters using an artificial neural network model. By using the Wastewater Treatment Plant inlet water data, outlet water values can be predicted as a result of Artificial Neural Network modeling, thus predicting sudden changes that occur during the operation of wastewater treatment plants and situations requiring intervention will be important in preventing environmental risks. Additionally, time and cost will be saved. It will set an example for similar processes.

*Keywords: Wastewater, Artificial Neural Network, Reuse*

## **1. INTRODUCTION**

The effects of global climate change and ecological footprint, which manifest themselves in the world and Turkey, reveal the necessity of sustainable and effective use of natural and renewable resources in the best and most efficient way. Approximately 90% of the population in Turkey and more than half of the world's population lives in cities. This situation has brought urban technical infrastructure facilities to an even more important point than ever before (Üçüncü, 2019).

The production of wastewater beyond what nature can absorb and the pollution of receiving environments brought about by population growth and industrialization are among the problems that directly and indirectly threaten human life today. In order to prevent this situation, which may negatively affect the ecological balance in nature, it has become necessary to treat wastewater before disposal. There is a treatment process that is difficult to manage in wastewater treatment plants established to purify wastewater from these pollutants and discharge it back to the receiving environment.

The long duration of some pollution measurement processes used in wastewater treatment plant (WWTP), process control, their high cost, and the need for urgent evaluation of their results from time to time cause the facility manager to need additional information systems to assist in decision making. Modeling the relationship between historical facility input and output parameters recorded in information systems and estimating possible output parameters for the input control parameter values encountered will support the plant manager in effectively managing the process and regulatory intervention (Öztemel ve Düğenci, 2016).

Many variables (non-linear and time-varying) need to be taken into account in the operation of domestic wastewater treatment plants. Although some of these variables can be measured in situ, some variables need to be measured in laboratories. For these reasons, when a problem is encountered in the operation of these facilities, it is not easy to overcome these problems and tools are needed to help overcome the problem (Çınar ve Yılmaz, 2005).

The concept of pollution, the importance of which was not realized in the past years; It has become very important nowadays. The best way to tackle this situation is to reduce pollution where it occurs, at its source. But as time went by, this situation began to become more complicated. It is obvious that

## **Proceeding Book of ISESER 2023**

today's pollution will cause major problems in the future. Based on this, researchers have started to create various models. The purpose of these models is to predict problems that may occur in the future, to reduce or completely prevent pollution, to improve ecosystems, to determine the efficiency of treatment plants without the need for laboratory-scale reactors, etc. (Subaşı, 2010)

Model development is a sophisticated and cost-effective way to control the operation of WWTPs and evaluate their performance (Hassen and Asmare, 2019).

Artificial Neural Networks (ANN) are computer software developed by imitating the information processing mechanism of the human brain in order to provide solutions to various problems. Created by simulating a biological neural network such as the human brain, ANNs have the ability to learn, memorize, generalize what they have learned to produce new information, and reveal the relationships between variables. It has been seen that ANN can successfully model the system in wastewater treatment (Erdem, 2021).

ANN analysis; It is an economical and useful method that can be used in the analysis of experimental studies related to environmental engineering, since doing more experimental studies is both costly and time-consuming. In the analysis of data in environmental engineering, input and outputs can be defined with the ANN method and output values can be estimated.

Efficient results can be achieved by using ANN models in the analysis of the studies. When the relationship between different parameters cannot be expressed with an equation, it would be logical to seek results with a complex system such as ANN. For this, regularly prepared data and accurate measurements are needed (Açıklan, 2007).

Due to its simplicity and predictive accuracy, the use of machine learning, especially ANN, to model the wastewater treatment process has become a promising alternative that can be realized with the advancement of computing capabilities.

Artificial neural network models use a set of nonlinear equations to determine complex patterns and relationships between input and output and can therefore be used in prediction, simulation and classification (Bekkari ve Zedduri, 2018).

In wastewater treatment plants, the most significant environmental issues during the operational phase are the potential impacts of the treated effluent on the receiving environment. It is important for facility process management to detect system malfunctions in a timely manner and take appropriate measures to ensure that these effects are kept to a minimum. In this study, the optimum algorithm that gives the data closest to the measured outlet water values will be investigated by using the inlet water data of the Konya Province Urban Wastewater Treatment plant through ANN Models.

With this study, it is aimed to estimate the effluent water values of the same parameters by determining the appropriate method from ANN models using the 2021-2022 inlet water parameters (pH, BOD, COD, AKM, TN, TP) of the Konya Urban Wastewater Treatment Plant. The importance of predicting sudden changes and situations requiring intervention that occur during the operation of wastewater treatment facilities in preventing environmental risks was a factor in determining this target.

Currently, WWTP inlet and outlet water analyzes are carried out using measurement and experimental methods. However, this situation causes loss of time and cost problems since the analyzes must be carried out in accordance with the standards. Obtaining results closest to actual measurement data with an appropriate model method will provide the opportunity for early intervention in important problems and will enable increased operating efficiency in facilities that already have high operating costs. It is aimed that the appropriate method obtained after the study can be used in other facilities of similar scale.

## **2.METHOD**

### **2.1 Konya Urban Wastewater Treatment plant general information**

Konya Urban Wastewater Treatment facility is located in Tatlıcak District of Karatay District. Currently, the site has a surface area of 110,000 m<sup>2</sup>, with an equivalent population of 1,000,000 people and a wastewater flow rate of 200,000 m<sup>3</sup>/day. It is designed for 2030 with an equivalent population of 1,600,000 people and a capacity of 300,000 m<sup>3</sup>/day. It works with advanced biological treatment + UV disinfection methods. At the exit of the Wastewater Treatment Plant, the treated water is given to Konya Main Discharge Channel. The facility is constantly monitored by the Ministry of Environment, Urbanization and Climate Change's wastewater monitoring systems.

**Proceeding Book of ISESER 2023**

In addition, electricity and heat energy are produced at the facility by using biogas resulting from the digestion of sludge formed during wastewater treatment. 2500 kWh of electricity is produced.

The stabilized treatment sludge produced in the facility is used in agricultural lands.

Applications are being made in green area irrigation with the 150 m<sup>3</sup>/h capacity application project for the reuse of treated wastewater. Thanks to this application, 3,216,000 m<sup>2</sup> of green area irrigation is carried out every year during the irrigation season with approximately 385,000 m<sup>3</sup>/season of recycled wastewater produced.

In parallel with the increasing population and urbanization rates, the capacity of the Konya wastewater treatment plant also needs to be increased. A second stage wastewater treatment plant is planned to serve 2,409,592 people and a flow rate of 400,000 m<sup>3</sup>/day in 2040. The planned facility also includes the Agricultural Irrigation Water Production Facility Unit from Treated Wastewater.





Figure 1. Konya WWTP general view and photos of the units

## 2.2 Material and method

With developing computer technologies, the use of artificial intelligence techniques has increased. ANNs are also included among these techniques. ANNs are one of the latest products of people's efforts to research and imitate nature. ANNs are programs designed to simulate the way simple biological neurons work.

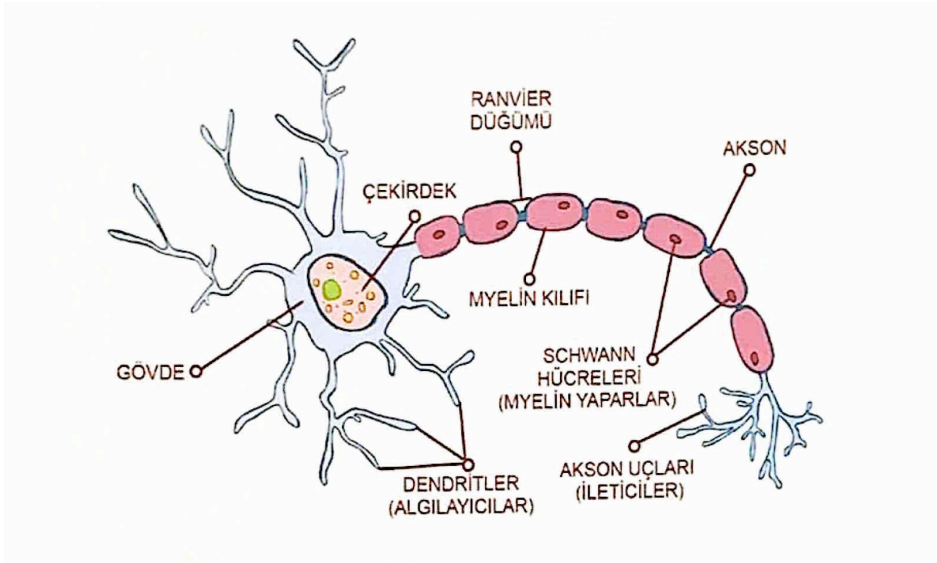

Figure 2. Biological nerve cell

Biological nerve cells communicate with each other through synapses. A nerve cell sends the information it processes to other cells via its axons. Similarly, artificial nerve cells collect external

Proceeding Book of ISESER 2023

information with an accumulation function and pass it through the activation function, producing the output and sending it to other cells (process elements) over the connections of the network. It has different collection and activation functions. The values of the connections connecting artificial neural networks to each other are called weight values. Process elements come together in 3 layers parallel to each other and form a network. These; • Input layer • Intermediate layers • Output layer. Information is transmitted to the network from the input layer. They are processed in the intermediate layers and sent to the output layer from there. What is meant by information processing is to convert the information coming to the network into output using the weight values of the network. In order for the network to produce correct outputs for inputs, the weights must have correct values. The process of finding the correct weights is called training the network. These values are initially assigned randomly. Then, when each example is shown to the network during training, the weights are changed according to the learning rule of the network. Then, another sample is presented to the network and the weights are changed again and the most accurate values are tried to be found. These processes are repeated until the network produces correct outputs for all the examples in the training set. Once this is achieved, the samples in the test set are shown to the network. If the network gives correct answers to the examples in the test set, the network is considered trained. (Öztemel,2012).

ANN have the capacity to learn, memorize and reveal the relationship between data. It consists of three basic stages.

- 1.Education
- 2.Verification
- 3.Test

Generally, 80% of the data obtained is used for training and 20% for validation. The accuracy of the model is also tested with data that has not been used before.

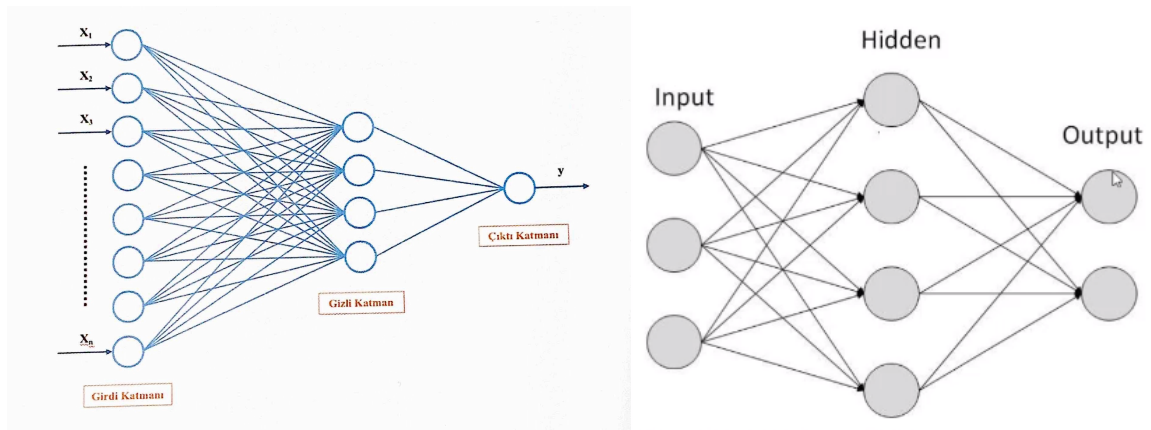

Figure 3. Artificial neural networks layers

An ANN cell consists of five basic components: input, weight, summation function, activation function and output.



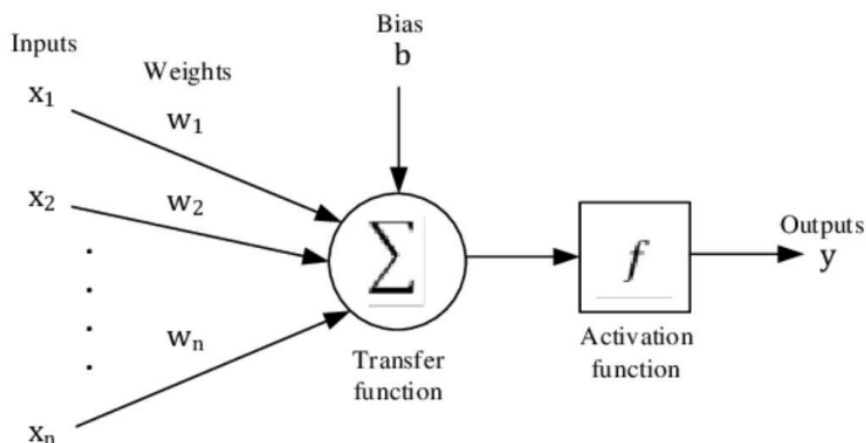

Figure 4. Structure of Artificial Nerve Cell

#### Some Advantages of Artificial Neural Networks

1. Artificial neural networks consist of many cells, and these cells work simultaneously and perform complex operations.
2. Certain types of non-linear subunits distributed on the structure make it possible to solve non-linear problems.
3. ANNs can perform machine learning. By learning about events, one can make logical decisions in the face of similar events.
4. They can make predictions faster than traditional methods and more successfully than the literature.
5. They can produce information about previously unseen samples. ANNs derive generalizations from the examples given to them during their training and can produce information about new examples with these generalizations.
6. There is error tolerance.

Nowadays, it is widely used in many areas such as classification, modeling and prediction applications. It is suitable for use in almost every field where machine learning algorithms are applied. It is also widely used in the field of engineering.

In the field of Environmental Engineering, studies are carried out to predict the performance of urban wastewater treatment plants using methods such as artificial neural networks. In this study, it was aimed to estimate the values of Konya Urban WWTP effluent parameters using an artificial neural network model.

Using the 2021-2022 WWTP inlet water values obtained from KOSKİ General Directorate, outlet water values will be estimated with the computer program of the appropriate ANN model.

In addition, the parameters for which data cannot be obtained from time to time in the WWTP inlet water values will be included in the process after determining the approximate values using appropriate methods.

Due to the difficulties encountered in estimating using classical methods or complex models and the dependence of performance on many parameters, this method was preferred because the appropriate ANN model facilitates the monitoring of the performances of wastewater treatment plants.

### 3. RESULTS

It is thought that this study will contribute to the literature on how determining the process controls and performances of Urban Wastewater Treatment Facilities can be done more practically with artificial intelligence methods such as artificial neural networks.

At the same time, it is envisaged that it will set an example for similar processes in that, with timely intervention in the facilities, possible problems that may occur in the facility units and the effects on the receiving environment can be reduced. In this way, time and cost will be saved.

**Proceeding Book of ISESER 2023**

We also believe that it will contribute to science at national and international levels and will serve as a preliminary study for all wastewater treatment facilities of similar structure.

**REFERENCES**

- Açıklım, S., 2007. Estimating wastewater treatment plant efficiency with artificial neural networks, Master's Thesis, Sakarya University, Institute of Science and Technology, Sakarya.
- Bekkari N. and Zedduri A., 2018. Using artificial neural network for predicting and controlling the effluent chemical oxygen demand in wastewater treatment plant, *Management of Environmental Quality: An International Journal* Vol. No. 30 3, pp. 593-608
- Çınar Ö. and Yılmaz A.S., 2005. Application of artificial neural networks to wastewater treatment plant operation: A case study, *KSÜ. Journal of Science and Engineering* 8(2), 48-49.
- Erdem, F., 2021. Modeling zn removal from wastewater with artificial neural network (ANN), *European Journal of Science and Technology Special Issue* 24, 335-342.
- Hassen E.B. and Asmare M.A., 2019. Predictive performance modeling of Habesha brewery wastewater treatment plant using artificial neural networks, *Chemistry International* 5(1), 87-96
- Öz Temel E., 2012. *Artificial Neural Networks Istanbul: Papatya Publishing Education*
- Öz Temel, E. and Dügenci, M., 2016. Pollution parameter estimation with artificial neural network in wastewater treatment plant control, *I SEM2016, 3rd International Symposium on Environment and Morality, Alanya, Proceedings Book*, 512-517.
- Subaşı, H., 2010. Modeling wastewater treatment plant performance with artificial neural networks, Master's Thesis, Çukurova University, Institute of Science and Technology, Environmental Engineering Department, Adana
- Third, O., 2019. Wastewater treatment, wastewater discharge and water pollution: Trabzon Province Example, *Turkish Hydraulic Magazine*, 3, 2, 14-29.  
<https://www.veribilimiokulu.com/yapay-sinir-aglari>

**O 35. INVESTIGATION OF PARAMETERS AFFECTING THE ADSORPTION PROPERTY OF PHOTOCATALYST IN THE REMOVAL OF ENDOSULFAN USING PHOTOCATALYSIS PROCESS**

Mehmet Turkyilmaz<sup>1\*</sup>, Sezen Kucukcongar<sup>1</sup>

*IKonya Technical University, Department of Environmental Engineering, Konya, Turkey*

E-mail: [aaaaaa mturkyilmaz@ktun.edu.tr](mailto:aaaaaa mturkyilmaz@ktun.edu.tr), [skucukcongar@ktun.edu.tr](mailto:skucukcongar@ktun.edu.tr)

**ABSTRACT:** The adsorption of organic pollutants is a prerequisite for a higher and efficient photodegradation process. Higher adsorption by the photocatalyst facilitates the degradation of the pollutants. Adsorption improves interfacial interactions between organic pollutant molecules and photocatalyst to increase the photosensitivity capability. In this study, the removal of endosulfan by the adsorption process of Ag/TiO<sub>2</sub>/Fe<sub>3</sub>O<sub>4</sub> photocatalyst was investigated. In order to determine the effects of endosulfan concentration, pH and catalyst amount parameters on the removal efficiency, the experimental design and optimization of the adsorption process using the Taguchi method and analysis of variance were performed. As a result of the highest S/N ratios obtained on the basis of parameters, 4 mg/L endosulfan concentration, pH 4 and 0.3 g/L catalyst amount were determined as optimum, and 85.02% removal efficiency was achieved. When the parameter effects on the removal efficiency are evaluated, the most effective parameters are the endosulfan concentration, pH and catalyst amount, respectively. The critical value showed that the endosulfan concentration was statistically effective on the removal. The error caused by uncontrollable factors remained below 50%, showing that the errors were not significant. When the %P values were examined, it was determined that there was a significant difference between the levels of endosulfan concentration and pH factors.

*Keywords: Endosulfan, Adsorption, Ag/TiO<sub>2</sub>/Fe<sub>3</sub>O<sub>4</sub>, Experimental design, Taguchi Method*

## **1. INTRODUCTION**

Persistent organic pollutants (POPs) are compounds that are resistant to photolytic, chemical and biological degradation in aquatic environments, can be detected in environmental matrices for many years due to their high half-life, can bio-accumulate due to their high lipophilicity, have high toxicity even at low concentrations, and as a result, they have long-range transport (Marican & Durán-Lara, 2018). Endosulfan is one of the most recent persistent organic chemical substances to be restricted under the Stockholm Convention, so its presence in environmental matrices is estimated to be high levels (UNEP/FAO/RC/CRC, 2010). Conventional treatment methods (such as coagulation- flocculation, activated sludge process, filtration and oxidation with chemicals such as chlorine, adsorption, membrane treatment) may not be effective in removing POPs from waters (Kumari, Bahadur, & Dumée, 2020). For this reason, various advanced water treatment technologies called advanced oxidation processes (AOP) are applied in the removal of POPs as they provide faster degradation kinetics as well as high removal efficiency. In recent years, greener technologies have been used more widely, therefore, it is preferred to use methods that reduce new waste generation after treatment, minimize the formation of by-products, and have lower energy and investment/operation costs. Heterogeneous photocatalytic processes, which can be used in existing reactors, are more environmentally friendly, green processes that can be applied using the addition of photocatalyst and a light source, provide the mineralization of organic materials without creating a new waste, and can operate with low energy consumption. In advanced oxidation processes, factors such as turbidity of water, solution pH, reaction time, amount/volume of degradable organic compound can significantly affect the decomposition activity of hydroxyl radical ( $\bullet$ OH) (Badmus, Tijani, Massima, & Petrik, 2018).

In the photodegradation process, besides the band gap and the light source, the adsorption capacity of organic pollutants on the photocatalyst surface is also important. Higher adsorption by the photocatalyst facilitates the degradation of the pollutants. Adsorption improves interfacial interactions between organic pollutant molecules and photocatalyst to increase the photosensitivity capability (Tachikawa, Fujitsuka, & Majima, 2007). There are studies that conclude that the adsorption of organic pollutants is a prerequisite for a higher and efficient photodegradation process. Guo et al. (2016) showed

## **Proceeding Book of ISESER 2023**

that for Rhodamine B and methyl orange dyes, the photodegradation ability of fluorinated TiO<sub>2</sub> (f-TiO<sub>2</sub>) is related to the adsorption on f-TiO<sub>2</sub>. Adsorption of organic pollutants by the photocatalyst is very important for their efficient degradation, as adsorption or interfacial interaction facilitates electron injection. As a result, complete degradation of organic pollutants makes the photocatalytic degradation process a more advantageous approach compared to adsorption. However, to achieve an excellent photodegradation rate, efficient adsorption of organic pollutants is also required (Gusain, Gupta, Joshi, & Khatri, 2019). Ismael et al. (2020) reported that there are two steps in the photocatalysis of pesticides, which are (i) adsorption onto the nanocomposite surface followed by (ii) photodegradation in the presence of UV radiation.

In this study, the effects of different initial ambient conditions on the adsorption efficiency of the photocatalyst were investigated in the removal of endosulfan by the photocatalysis process. TiO<sub>2</sub>, which was synthesized together with Fe<sub>3</sub>O<sub>4</sub> and doped with silver as a noble metal, was used as a photocatalyst in order to provide magnetic properties to the nanomaterial, to increase the removal efficiency and to ensure high efficiency under different radiations (UV-A, UV-C and visible light). Initial solution pH, photocatalyst amount and initial endosulfan concentration were selected as different ambient conditions, and Taguchi experimental design and analysis of variance (ANOVA) methods were applied to determine their effects on the adsorption of endosulfan.

## **2. MATERIAL AND METHOD**

### **2.1. Material**

Nano-sized titanium (IV) oxide (Degussa P25, 50 m<sup>2</sup>/g, 75% anatase and 25% rutile), silver nitrate (AgNO<sub>3</sub>) and, ammonium hydroxide (NH<sub>4</sub>OH, 30% v/v aqueous solution) were obtained from Sigma Aldrich; ferrous sulfate heptahydrate (FeSO<sub>4</sub>.7H<sub>2</sub>O) and ferric chloride (FeCl<sub>3</sub>) were obtained from Merck KGaA for the synthesis of photocatalyst.  $\alpha$ + $\beta$ -endosulfan (99.5%) in chromatographic purity for the preparation of standard and stock solutions of endosulfan isomers is purchased from Sigma Aldrich company, acetone used as solvent, high purity n-hexane (C<sub>6</sub>H<sub>14</sub>) used in the extraction of endosulfan isomers and metabolites and, acetonitrile (C<sub>2</sub>H<sub>3</sub>N) used as carrier phase was obtained from Merck KGaA.

### **2.2. Method**

For photocatalyst synthesis, photochemical deposition method was used for doping TiO<sub>2</sub> with silver, and heteroagglomeration method was used for combining it with Fe<sub>3</sub>O<sub>4</sub>. Information on the application of the methods is explained in detail in our previously published study (Turkyilmaz & Kucukcongar, 2022). X-ray diffraction (XRD), scanning electron microscopy (SEM), transmission electron microscope (TEM) and energy dispersive X-ray spectroscopy (EDX - EDS) analyzes were used to examine the structure and surface morphology of the synthesized photocatalyst. It was carried out on devices in the Research and Application Center.

The vortex assisted liquid-liquid micro-extraction (VALLME) method was used for the extraction of endosulfan isomers from the aquatic environment. In the method in which n-hexane is used as the extraction solvent, optimum conditions were applied at maximum vortex speed, 10 mL sample volume, 3 min vortex time and 200  $\mu$ L solvent volume. Phase separation was carried out by centrifugation at 3000 rpm for 2 minutes, after the extraction. Detailed information about the optimization of the method is given in our previous study (Turkyilmaz & Küçükçongar, 2021). Detection of endosulfan isomers was performed with the Shimadzu Prominence-i 2030-3d HPLC liquid chromatography system. Compounds were monitored using a two-channel UV/VIS/PDA dual absorbance detector separated on a GL Science C18 (250 mm x 3.1 mm i.d.) reversed phase column. The column temperature was used at ambient temperature and the injection was carried out with an autosampler. The mobile phase was formed from acetonitrile:water mixture adjusted to 70:30 by volume at a flow rate of 1 mL/min. The injection volume was determined as 20  $\mu$ L and endosulfan and its metabolites were detected at 214 nm.

In the batch photocatalysis experiments, photocatalyst was added to the synthetic solution prepared under the initial conditions suitable for the orthogonal array (Table 1) determined according to the Taguchi experimental design method, and first of all, it was ensured that the catalyst reached the adsorption equilibrium by shaking in the dark environment. Afterwards, photocatalysis experiments were carried out using suitable light sources. In this study, it was aimed to examine the effect of different environmental conditions on the efficiency of the adsorption process just before the photocatalysis

## **Proceeding Book of ISESER 2023**

process. For this purpose, three different levels were determined for three different variables in experimental studies. In the experiments, 3 different levels were applied as 4, 7 and 10 values for the initial pH, 0.1, 0.3 and, 0.5 g/L for the photocatalyst amount and, 2, 3 and, 4 mg/L for the endosulfan concentration. After 30 minutes of adsorption for each experimental condition, the photocatalyst was separated with an external magnet and the endosulfan concentration remaining in the solution was analyzed, and the percentage of removal by adsorption was calculated. According to the results of the experiment, the optimization was made with the Taguchi experimental design method with the "larger is better"; preference and the effects of the parameters were determined using the analysis of variance.

### **3. RESULTS AND DISCUSSION**

#### **3.1. Photocatalyst Characterization**

In this study, it was aimed to determine the contribution of the synthesized Ag/TiO<sub>2</sub>/Fe<sub>3</sub>O<sub>4</sub> catalyst to the removal by adsorption and the effects of the selected control parameters on the adsorption, before the endosulfan removal by the photocatalysis process.

For this purpose, Ag/TiO<sub>2</sub> catalyst was first produced by bonding Ag to TiO<sub>2</sub> by photochemical deposition method. Then, Ag/TiO<sub>2</sub>/Fe<sub>3</sub>O<sub>4</sub> catalyst was synthesized by connecting Fe<sub>3</sub>O<sub>4</sub> to Ag/TiO<sub>2</sub> by heteroagglomeration method. XRD, SEM-EDX, TEM-EDS analyzes were performed to examine the structural properties of the prepared catalysts. The crystal structures and compositions of the catalysts were characterized by the XRD diffraction model. The results confirmed that the synthesized catalysts contained Ag, Ti, O and Fe components and were free of impurities. The surface morphologies of the catalysts were determined by SEM analysis. Ag, Ti, O and Fe mass ratios were determined in EDX spectrum analyzes. The results showed that the main elements Fe, O, Ag and Ti were present without unexpected elements being observed, and this Ag supported magnetic TiO<sub>2</sub> was successfully prepared and confirmed the purity of the synthesized catalyst. TEM-EDS analyzes confirmed that the main elements in the synthesized Ag/TiO<sub>2</sub> and magnetic Ag/TiO<sub>2</sub>/Fe<sub>3</sub>O<sub>4</sub> catalyst are Ti, O, Fe and Ag. It revealed that the nanocomposite is pure without any scattered impurities. It was also confirmed by mapping that the expected elements were well distributed throughout the catalyst sample (Turkyilmaz & Kucukcongar, 2023).

#### **3.2. Adsorption experiments**

Adsorption experiments were carried out in accordance with the order of initial conditions determined according to the Taguchi experimental design method. The effects of catalyst amount, initial endosulfan concentration and pH parameters on removal efficiency were investigated. After the experiments were completed, the photocatalyst was separated from the samples with the help of an external magnet. Endosulfan was extracted with VALLME and HPLC readings were made. Taguchi optimization and analysis of variance of the results obtained in the experiments were made using Minitab 19 program and the results are given below.

In order to determine the time required for the adsorption to reach equilibrium, agitation was carried out in the dark. Equilibrium data for 6 different times between 10-60 min were obtained for 2.5 mg/L initial endosulfan concentration, 0.05 g catalyst amount and pH 7. The adsorption capacity reached its maximum in the first 30 minutes and then decreased and stabilized in the next period. Therefore, the reaction time was applied as 30 min for the effect and optimization of the control parameters in the adsorption experiments to be carried out in the Taguchi experimental design. Similarly, Ismael et al. (2020) reported that the adsorption equilibrium was reached in 20 minutes for the removal of chlorinated pesticides from wastewater, with the TiO<sub>2</sub>/GO/CuFe<sub>2</sub>O<sub>4</sub> nanocomposite photocatalyst.

The S/N ratios obtained from the Taguchi experimental design program of the endosulfan removal efficiencies obtained in the experiments on the basis of parameters suitable for the "Larger is better" design and the estimated S/N ratios of the program are given in Tables 1 and 2. When we evaluate the effect orders and levels of the parameters on the removal efficiency from the tables, it is seen that the most effective parameter according to the estimated S/N ratio is the initial endosulfan concentration (4 mg/L at the third level), pH (first level, 4) and the amount of catalyst (second level, 0.3 g/L). Since these results are included in the experiment design table (experiment 12), there is no need for a further confirmation experiment. Since these results are included in the experiment design table (experiment 12), there is no need for a further confirmation experiment. In addition, since the highest removal

**Proceeding Book of ISESER 2023**

efficiency was obtained at these levels with 85.02%, it can be stated that the test result and the analysis result of the experimental design program are compatible.

**Table 1.** The endosulfan adsorption efficiencies obtained for the initial conditions determined according to the experimental design method.

Sample No.	pH	Catalyst Amount (g/L)	Endosulfan Conc. (mg/L)	% Removal	S/N	Predicted S/N
1	4	0.1	2	20,38	26,1841	30,1329
2	4	0.1	3	45,95	33,2457	33,6204
3	4	0.1	4	64,19	36,1493	35,2090
4	7	0.3	2	22,72	27,1282	31,0536
5	7	0.3	3	44,01	32,8710	34,5410
6	7	0.3	4	65,20	36,2850	36,1296
7	10	0.5	2	34,54	30,7664	29,4440
8	10	0.5	3	43,12	32,6936	32,9314
9	10	0.5	4	46,52	33,3528	34,5200
10	4	0.3	2	35,80	31,0777	31,4080
11	4	0.3	3	79,18	37,9723	34,8954
12	4	0.3	4	85,02	38,5904	36,4840
13	7	0.5	2	42,90	32,6491	30,9618
14	7	0.5	3	48,99	33,8021	34,4492
15	7	0.5	4	67,22	36,5500	36,0378
16	10	0.1	2	34,08	30,6500	28,2607
17	10	0.1	3	31,62	29,9992	31,7482
18	10	0.1	4	40,70	32,1919	33,3367
19	4	0.5	2	34,66	30,7966	31,3162
20	4	0.5	3	48,80	33,7684	34,8037
21	4	0.5	4	66,66	36,4773	36,3922
22	7	0.1	2	40,89	32,2323	29,7785
23	7	0.1	3	62,94	35,9785	33,2660
24	7	0.1	4	47,73	33,5758	34,8545
25	10	0.3	2	33,14	30,4071	29,5358
26	10	0.3	3	44,40	32,9477	33,0232
27	10	0.3	4	52,50	34,4032	34,6118

**Table 2.** Response Table for Signal to Noise Ratios in Absorption Experiments (Larger is better)

Level	pH	Catalyst	Endosulfan
1	33,81	32,25	30,21
2	33,45	33,52	33,70
3	31,93	33,43	35,29
Delta	1,87	1,28	5,08
Rank	2	3	1

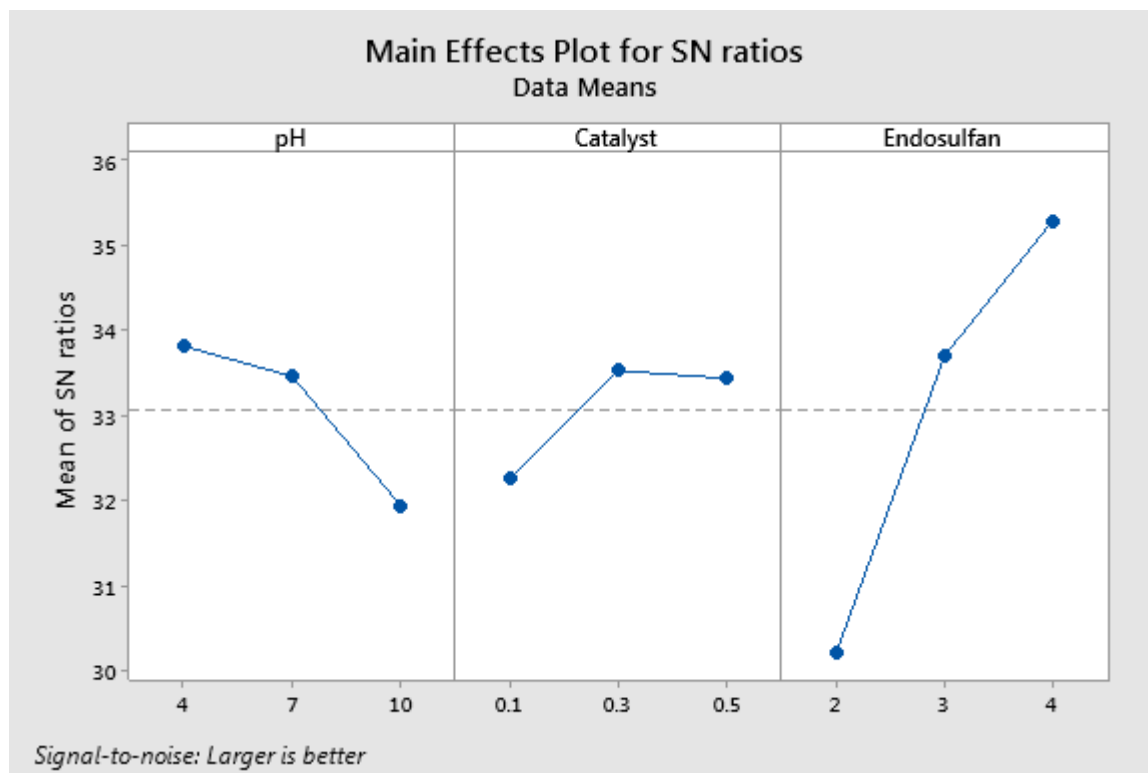

Figure 1. S/N ratios of parameters in adsorption experiments.

When Figure 1 is examined, the following conclusions can be reached;

- Since solution pH is a factor that affects the properties of pesticide molecules, adsorbent surface charge, ionization, functional groups in active sites, as well as the chemical properties of the solution (solubility, etc.), it is an important parameter to examine in the adsorption process. In the acidic state, the surface of the catalyst is positively charged, which is beneficial for the catalyst to absorb negatively charged organic compounds. In an alkaline state, however, there will be significantly less interaction due to the repulsion between the negatively charged catalyst surface and organic compound anions (Huang et al., 2008; Lu, Yang, Fang, Li, & Jiang, 2017). For this reason, as seen in Figure 1, the shift of the pH value from the acid medium to the neutral and basic medium had a reducing effect on the yield, and the pH 4 value was taken as the optimum. It has also been stated that low pH limits the formation of rust on the iron surface and provides more availability of the active sites of the adsorbent for the pollutant (Dong, Zhao, Zhao, & Zhou, 2010; Shih & Tai, 2010). It has been reported that under basic conditions, the formation and deposition of the hydroxide layer on the iron surface increases, resulting in less reactivity of FeO (Shih & Tai, 2010). Rauf, Tahir, Kang, and Chang (2012) reported that with increasing pH value, the amount of alpha and beta endosulfan adsorbed by bentonite decreased. Similarly, S. Memon, Memon, Memon, and Latif (2011) investigated the effect of pH between 2-12 values in their study on endosulfan adsorption with calix(4)eren and reported that the adsorption percentage was highest at acidic pH. In the study on nitrate removal with magnetic nanoparticles, it was reported that nitrate removal was pH dependent, maximum removal was achieved with 90.26% at the original sample pH of 6.9, and nitrate removal efficiency began to decrease above pH 6.9. It has been stated that this decrease in efficiency at high pH is probably due to the repulsion force between the OH<sup>-</sup> ion that negatively charges the surface of magnetic nanoparticles and the negatively charged nitrate ions (Pourzamani, Mengelizadeh, Jalil, & Moosavian, 2017).
- The amount of adsorbent is an important parameter that affects the adsorption capacity and pollutant concentration. The increase in the amount of adsorbent effectively increased the S/N ratio at doses of 0.1 to 0.3 g/L. This can be attributed to the increased adsorbent surface area

**Proceeding Book of ISESER 2023**

and the availability of more adsorption sites resulting from the increased adsorbent dose. However, increasing the amount to 0.5 g/L had a slight negative effect on the removal. This negative situation was reported by S. Memon et al. (2011) and Rauf et al. (2012) have also been reported in their study. The result shows that as the adsorbent concentration increases, the adsorption percentage generally increases, but as the amount of adsorbate is fixed, the amount adsorbed per unit mass of the adsorbent decreases due to the unsaturated adsorption sites during the adsorption process (G. Z. Memon, Bhangar, & Akhtar, 2009).

- The initial endosulfan concentration is the most effective parameter on the removal efficiency, and the increase in concentration increased the efficiency. This is likely because when the initial endosulfan concentration is high, the number of pesticide molecules available with which the active site of the adsorbent interacts increases, resulting in higher removal efficiencies. Mishra and Patel (2008) reported that the removal rate of endosulfan was increased by increasing the initial endosulfan concentration from 5 mg/L to 15 mg/L in their study examining the removal of endosulfan from water with Sal Wood charcoal.

After determining the control parameters in terms of endosulfan adsorption efficiencies, ANOVA analyzes of the results obtained from the experimental design procedure were performed (Table 3). Thus, the extent to which the investigated factors affect the total adsorption efficiency and how different levels cause variability were also investigated.

**Table 3.** Analysis of Variance

Source	DF	Seq SS	Contribution	Adj SS	Adj MS	F-Value	P-Value
pH	2	836,0	12,59%	836,0	418,0	3,61	0,0458
Catalyst	2	305,0	4,59%	305,0	152,5	1,32	0,2899
Endosulfan	2	3184,7	47,96%	3184,7	1592,3	13,76	0,0002
Error	20	2314,0	34,85%	2314,0	115,7		
Total	26	6639,7	100,00%				

Evaluation of the ANOVA analysis results is made by considering the F ratio, P% values and contribution percentage data. The F ratio is compared with the Fcritical value determined for a certain confidence interval value from the statistical tables, and if the F ratio is greater than the Fcritical value determined from the table in the predicted confidence interval, it is concluded that the effect of the specified factor is important for the performance examined (Özçelep, 2009). The degrees of freedom of each factor are 2 and the degrees of freedom of error are 20, for endosulfan adsorption removal. In this case, the Fcritical value was determined as 3,634 (F0.05;2.20) for the 95% confidence interval (Land, 1971).

In the experimental design part, since we are working with the criterion of "Larger is better", the value with the highest F value represents the most important parameter. When the F ratios in Table 3 are compared with the Fcritical value, we can state that the effect of the initial endosulfan concentration is statistically significant. The value given as error in the table means error caused by uncontrollable factors (noise). It is important for the reliability of the results that this value is below 50%; otherwise, the results will not be reliable (Özçelep, 2009). As can be seen in Table 3, the calculated error value of 34.85% remained below the 50% value, indicating that the errors of the experiments were not significant.

The %P values in the analysis of variance are used to quantitatively evaluate the effects of the factors. Significance can be evaluated between groups according to %P values. In cases where this value is less than 0.05, we conclude that there is a significant difference between the groups. When Table 3 is examined, it is seen that there is a significant difference between the initial endosulfan concentration (P=0.0002) and the levels of the pH factor (0.0458) for endosulfan removal. In addition, the contribution of the parameters to the removal is given as % value in the table. The initial endosulfan concentration



**Proceeding Book of ISESER 2023**

was the highest contributing factor with 47.96%. It is another factor that has the highest contribution on pH removal with 12.59%.

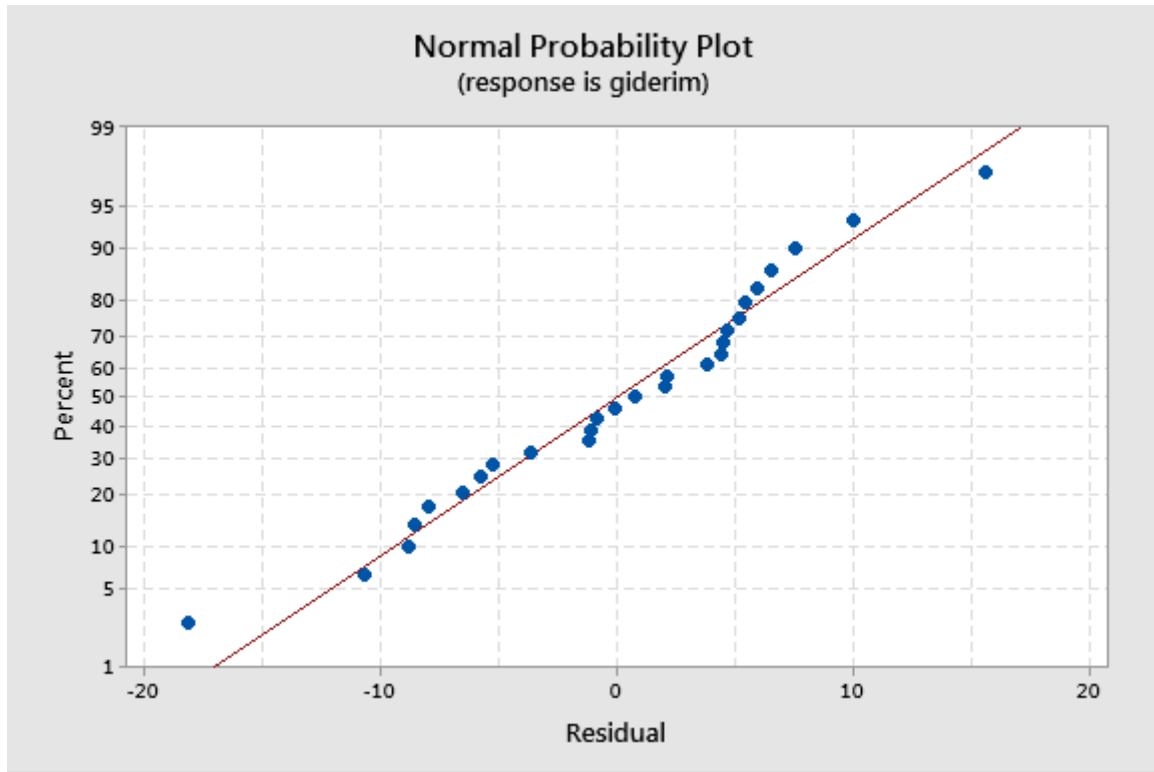

Figure 2. Normal probability plot for total endosulfan removal in adsorption experiments. The normal probability plot for endosulfan removal by the adsorption process is given in Figure 2. From the figure it can be seen that in the normal probability plot of the linear model, the residuals are reasonably close to the straight line. This means that the errors are normally distributed and that the terms specified in the model are significant. The  $R^2$  values of the model are given in Table 4.  $R^2$  value; It shows how well the data fit the model. The higher the  $R^2$  value, the more the data fit the model. The  $R^2$  value is 65.15% suitable for the model created according to the experimental results of endosulfan removal.

**Table 4.** Model Summary of Adsorption Experiments

S	R-sq	R-sq(adj)	PRESS	R-sq(pred)	AICc	BIC
10,75	65,15%	54,69%	4217,22	36,48%	220,80	223,16

**4. CONCLUSION**

High photocatalytic activity is expected as a result of high adsorption. For this reason, for the endosulfan removal and degradation to metabolites experiments by the photocatalysis process, firstly, the adsorbing process of the catalyst was carried out by shaking in the dark. In the next step of the study, experimental design of the photocatalysis process with Taguchi method and analysis of variance (ANOVA) for endosulfan removal and degradation to metabolites were performed.

After the adsorption process, photocatalysis experiments were applied to the samples under UV-A LED, UV-C and visible LED light sources in accordance with the initial conditions order determined according to the experimental design method. The effects of light intensity, catalyst amount, initial endosulfan concentration, pH and time parameters on removal efficiency were investigated. The highest removal efficiency was obtained as 91.9% , 93.2 and 94.2 % under UV-A LED, UV-C and visible LED light sources, respectively. In addition, when we evaluated the effects of the parameters on the removal efficiency, it was seen that the most effective parameters were the initial endosulfan concentration and pH.

## **Proceeding Book of ISESER 2023**

In addition, it was followed whether metabolite formation as a result of endosulfan degradation. For this purpose, the concentrations of the main metabolites endosulfan sulfate, endosulfan lactone and endosulfan ether were monitored. As a result, metabolite formations at high concentrations were not observed while endosulfan was removed, on the contrary, the formations remained below 2% in all experiments on a concentration basis. These results support that the adsorbed endosulfan is effectively degraded by the photocatalysis process.

The repeated use of a photocatalyst is an important issue in the practical application of a catalysis process. The Ag/TiO<sub>2</sub>/Fe<sub>3</sub>O<sub>4</sub> catalyst produced for this purpose was studied 5 times in a row. Similar removal efficiencies of approximately 80% were obtained in four replicates after the first trial. This result shows that the endosulfan adsorbed by Ag/TiO<sub>2</sub>/Fe<sub>3</sub>O<sub>4</sub> catalyst is degraded by the photocatalysis process. The obtained results confirmed that the catalyst must have an effective adsorption capacity for an effective photocatalysis to occur.

### **Acknowledgements**

I would like to thank the Republic of Turkey Higher Education Institution for the financial support it has provided with the 2014-ÖYP-106 project.

### **Funding**

The Republic of Turkey Higher Education Institution provided financial support for the analysis of the 2014-ÖYP-106 project.

### **Ethical Approval**

This article does not contain any studies with human participants or animals performed by the author

### **Conflict of Interest**

The author declares that he has no conflict of interest

### **Author contributions**

All authors contributed to the study conception and design. Material preparation, data collection and analysis were performed by Mehmet Turkyilmaz and Sezen Kucukcongar. All authors commented on previous versions of the manuscript. All authors read and approved the final manuscript.

### **REFERENCES**

- Badmus, K. O., Tijani, J. O., Massima, E., & Petrik, L. (2018). Treatment of persistent organic pollutants in wastewater using hydrodynamic cavitation in synergy with advanced oxidation process. *Environmental Science and Pollution Research*, 25(8), 7299-7314.
- Dong, J., Zhao, Y., Zhao, R., & Zhou, R. (2010). Effects of pH and particle size on kinetics of nitrobenzene reduction by zero-valent iron. *Journal of environmental sciences*, 22(11), 1741-1747.
- Guo, J., Yuan, S., Jiang, W., Yue, H., Cui, Z., & Liang, B. (2016). Adsorption and photocatalytic degradation behaviors of rhodamine dyes on surface-fluorinated TiO<sub>2</sub> under visible irradiation. *RSC Advances*, 6(5), 4090-4100.
- Gusain, R., Gupta, K., Joshi, P., & Khatri, O. P. (2019). Adsorptive removal and photocatalytic degradation of organic pollutants using metal oxides and their composites: A comprehensive review. *Advances in colloid and interface science*, 272, 102009.
- Huang, M., Xu, C., Wu, Z., Huang, Y., Lin, J., & Wu, J. (2008). Photocatalytic discolorization of methyl orange solution by Pt modified TiO<sub>2</sub> loaded on natural zeolite. *Dyes and Pigments*, 77(2), 327-334.
- Ismael, A., El-Shazly, A., Gaber, S., Rashad, M., Kamel, A., & Hassan, S. (2020). Novel TiO<sub>2</sub>/GO/CuFe<sub>2</sub>O<sub>4</sub> nanocomposite: a magnetic, reusable and visible-light-driven photocatalyst for efficient photocatalytic removal of chlorinated pesticides from wastewater. *RSC Advances*, 10(57), 34806-34814.
- Kumari, P., Bahadur, N., & Dumée, L. F. (2020). Photo-catalytic membrane reactors for the remediation of persistent organic pollutants—A review. *Separation and Purification Technology*, 230, 115878.
- Land, C. E. (1971). Confidence intervals for linear functions of the normal mean and variance. *The Annals of Mathematical Statistics*, 1187-1205.
- Lu, D., Yang, M., Fang, P., Li, C., & Jiang, L. (2017). Enhanced photocatalytic degradation of aqueous phenol and Cr (VI) over visible-light-driven Tb<sub>x</sub>O<sub>y</sub> loaded TiO<sub>2</sub>-oriented nanosheets. *Applied Surface Science*, 399, 167-184.

**Proceeding Book of ISESER 2023**

- Marican, A., & Durán-Lara, E. F. (2018). A review on pesticide removal through different processes. *Environmental Science and Pollution Research*, 25(3), 2051-2064.
- Memon, G. Z., Bhangar, M. I., & Akhtar, M. (2009). Peach-nut shells-an effective and low cost adsorbent for the removal of endosulfan from aqueous solutions. *Pak. J. Anal. Environ. Chem*, 10(1), 14-18.
- Memon, S., Memon, N., Memon, S., & Latif, Y. (2011). An efficient calix [4] arene based silica sorbent for the removal of endosulfan from water. *Journal of hazardous materials*, 186(2-3), 1696-1703.
- Mishra, P., & Patel, R. (2008). Removal of endosulfan by sal wood charcoal. *Journal of hazardous materials*, 152(2), 730-736.
- Özçelep, B. (2009). *Kağıt endüstrisi atıksularının membran prosesleriyle ileri arıtımı*. Doktora Tezi, İstanbul Teknik Üniversitesi, Fen Bilimleri Enstitüsü, İstanbul.
- Pourzamani, H. R., Mengelizadeh, N., Jalil, M., & Moosavian, Z. (2017). Nitrate Removal from Aqueous Solutions by Magnetic Nanoparticle. *Journal of Environmental Health and Sustainable Development*, 2(1), 187-195.
- Rauf, N., Tahir, S., Kang, J.-H., & Chang, Y.-S. (2012). Equilibrium, thermodynamics and kinetics studies for the removal of alpha and beta endosulfan by adsorption onto bentonite clay. *Chemical Engineering Journal*, 192, 369-376.
- Shih, Y.-h., & Tai, Y.-t. (2010). Reaction of decabrominated diphenyl ether by zerovalent iron nanoparticles. *Chemosphere*, 78(10), 1200-1206.
- Tachikawa, T., Fujitsuka, M., & Majima, T. (2007). Mechanistic insight into the TiO<sub>2</sub> photocatalytic reactions: design of new photocatalysts. *The Journal of Physical Chemistry C*, 111(14), 5259-5275.
- Turkyilmaz, M., & Kucukcongar, S. (2022). Investigation of Endosulfan Removal and Metabolite Formation by Photocatalysis Process under UV-C Light Source Using Taguchi Experimental Design Program. *International Journal of Environmental Analytical Chemistry*, 1-14.
- Turkyilmaz, M., & Kucukcongar, S. (2023). A comparison of endosulfan removal by photocatalysis process under UV-A and visible light irradiation: optimization, degradation byproducts and reuse. *Journal of Environmental Health Science and Engineering*, 1-17.
- Türkyılmaz, M., & Küçükçongar, S. (2021). Endosulfan ve Metabolitlerinin Su Örneklerinde Vorteks Destekli Sıvı-Sıvı Mikro Ekstraksiyon ve Yüksek Performanslı Sıvı Kromatografi Kullanılarak Analizi. *Bitlis Eren Üniversitesi Fen Bilimleri Dergisi*, 10(4), 1404-1415.
- UNEP/FAO/RC/CRC. (2010). Listing of chemicals in Annex III to the Rotterdam Convention: review of notifications of final regulatory actions to ban or severely restrict a chemical: endosulfan. *Chemical Review Committee Sixth meeting*. Geneva.

**O 36. THE IMPORTANCE OF CONSERVATION AND THE RESTORATION OF  
HISTORICAL GARDENS AS SUSTAINABLE CULTURAL HERITAGE**

Pembe Duran<sup>1\*</sup>, Aslı Güneş Gölbeç<sup>1</sup>

<sup>1</sup>*İzmir Demokrasi University, Architecture Faculty, Landscape Architecture Department*

E-mail: *duranpembe@gmail.com, asli.gunes@idu.edu.tr*

**ABSTRACT:** The concept of cultural heritage can be explained as a set of concrete or abstract works that enable the events that have occurred throughout human history to be transferred to subsequent generations. When these works, which contain different living styles, values, beliefs, and cultures of different periods, are evaluated from an architectural perspective, they generally focus on the constructional buildings and dwellings where that period prevailed. However, many dwellings that contain the lifestyle of the period are surrounded by the environment or gardens that have the lifestyle of the period. These gardens, where a part of the social life of the period continued, bear the traces of the period and are shaped according to the socio-cultural structure. These historical buildings surrounded by gardens are aging over time, their functions are changing, and they need restoration and renovation works in order to survive. At this point, the architectural structure and its surroundings are separated, and while many structures are restored and returned to their former state, unfortunately, the same sensitivity is not shown for the gardens. This situation causes damage, especially for gardens containing living material, and in some cases, even completely changing their function and using them for other purposes. In this study, in addition to the structures considered cultural heritage, the importance of the protection and restoration of their environments, namely their gardens, and their transfer as cultural heritage are discussed through various examples.

*Keywords: Historical Gardens, Garden Restoration, Conservation, Landscape Architecture, Cultural Heritage*

#### **4. INTRODUCTION**

Cultural landscapes are actualities derived from a protracted and intricate history of human interaction with the natural world. Humans have impacted the environment through their activities, and geography and natural resources have shaped the history and way of life of human cultures. The gardens are one of these sculpted, historically, and culturally rich areas; they are among the most exquisite, yet fragile, examples of cultural and landscape heritage. Both the aesthetic ideals and the spirit of the era in which they were constructed are preserved in them. This is particularly true with historical gardens, which are important to comprehend and protect due to the significance of what they symbolise (Silva & Carvalho, 2022).

They can add to our knowledge of other pillars of society as well as disciplines like science, anthropology, technology, history, and literature by shedding light on the interactions that have developed throughout time between cultures and the natural environment. According to this viewpoint, landscapes can be considered cultural heritage as long as they are passed down to future generations as inherited, utilised, and constantly changing goods. The landscape has many of the natural and cultural expressions recognised by the UNESCO Convention on the Protection of the World Cultural Heritage because of this interaction, which has resulted in an inseparable combination of natural and cultural components. The historical garden is a creation of societies, a window into their past and many cultures; it captures historical events as well as the interaction between humans and the natural world. It is a "living monument" because of the intricate architecture that combines life with immobility. (Silva & Carvalho, 2022).

#### **2. THE HISTORICAL GARDEN CONCEPT**

A historical garden is defined as an architectural garden composition that is historically or artistically significant, attesting to a culture, a specific culture, and an original vision of the artist, as stated in the Statute of Historic Gardens of Florence (1981). A historic garden is made to be observed and enjoyed, but entry is restricted to prevent the loss of the garden's natural features, history, and culture

**Proceeding Book of ISESER 2023**

(Fig 1). Historical gardens are also intricate systems with significant ecological, financial, artistic, cultural, and historical significance (Carrari et al., 2022). The historical garden is an architectural composition with a large number of biodegradables, plant-based elements. As a result, they depict the continual harmony between nature's development and decay, the seasons' changing look, and the efforts of artists and craftspeople to preserve it forever (Salwa, 2014). A historical garden is an area established with a specific goal in mind. Historical gardens are frequently designed to capture the history and culture of a certain location or era. Historical gardens are significant for lots of reasons. One of the primary reasons for this is their capacity to provide us with an understanding of the past and to inspire gardening now, particularly in the area of landscape design (Copeland, 2016).



**Figure 1.** Hevsel Gardens, Diyarbakır, Turkey (Anonim, 2023a).

### **2.1. Historical Gardens as Cultural Heritage**

Historical gardens are defined as works that encompass a variety of garden types, such as formal or informal, classical or baroque, romantic or cultural landscapes, and are considered part of the cultural heritage. These unique works of art carry a certain cultural value. A historical garden is defined by its character and historical significance, by what it represents in terms of monumentality, identity, and culture, by the value it adds to the locations and monuments it may be associated with, and by the things it awakens today. Historical gardens are not defined by their age, structure, or size (Silva & Carvalho, 2022).

The latter half of the 20th century witnessed the broadening of the notion of heritage to encompass more aspects, such as architectural landmarks. A growing fascination with various landscapes, natural landmarks, and locations—including parks and gardens—was the driving force behind this shift. Gardens have emerged as significant cultural and historical artefacts that transcend various civilizations and societies. They serve as crucial means for preserving and enhancing the cultural memory and collective identity of a society. Consequently, gardens are regarded as highly valuable and delicate manifestations of cultural and landscape heritage (Salwa, 2014).



**Figure 2.** Dolmabahçe Palace Garden - 1958 (Anonym, 2023b)

For all these reasons, it is felt that it is necessary and urgent to know, preserve, cultivate, protect, and value this heritage. In the context of sustainability, historical gardens provide ecosystem services such as:

- carbon storage,
- thermal island reduction,
- air pollution alleviation
- flow control.

Also, ecosystem-supporting services,

- providing habitats for a range of plant and animal species

And powerful cultural services,

- artistic,
- aesthetic,
- entertainment
- spiritual/emotional.

They can also be economically attractive due to their tourist attractions and capacity to create jobs. (Carrari et al., 2022).

## **2.2. The Conservation and Restoration of Historical Gardens as a Sustainable Cultural Heritage**

The issue of conservation of historical garden complexes was dealt with in the Florence Statute, adopted on 21 May 1981 by the ICOMOS-IFLA International Committee and the International Committee of Historic Gardens (Salwa, 2014).

Understanding and effectively managing historical gardens, which are considered cultural landscapes, play a crucial role in promoting sustainability. There is growing concern about sustainability and the big effect that changes in climate, population, society, and ideology have on cultural landscapes. This calls for a close look at how to understand, manage, and value historical gardens, as well as the importance of inventories in this situation (Silva & Carvalho, 2022).

**Proceeding Book of ISESER 2023**

Historical gardens possess significant value as both natural and cultural heritage areas, offering several socio-cultural, environmental, and economic advantages. In order to maintain their survival, living entities necessitate consistent, high-quality, and enduring protection (Funsten et al., 2020). Preservation of the original form of a historical garden is essential for maintaining its inherent historical significance, so ensuring its integrity is upheld to a satisfactory extent. Alternatively, the garden cannot be regarded as anthropomorphic but rather as an outcome of natural phenomena.

According to Salwa (2014), the purpose of a historic garden is to facilitate visitation and observation. However, it is imperative to restrict access to these gardens in order to save their cultural, historical, and natural significance from the threat of disappearance. The use of historical gardens for recreational and entertainment purposes should be limited to extraordinary situations. The inclusion of extraordinary types of physical pleasure and amusement within these spaces ought to enhance the garden's worth rather than diminish it. It is widely acknowledged that legacy holds significance not only from a historical and cultural standpoint but also plays a crucial role in fostering sustainable development and prosperity. The preservation of heritage holds significant policy significance, as seen by its inclusion in international texts like Goal 11.4 of the United Nations Sustainable Development Goals. This goal specifically emphasises the need to enhance endeavours aimed at safeguarding both the cultural and natural heritage of the globe (Figure 3).



**Figure 3.** Sustainable Development Goals. (Unitar, 2023)

According to its definition of landscape management, the European Landscape Convention places a high priority on sustainability. According to this convention, landscape management involves taking actions to ensure the ongoing upkeep of landscapes from a sustainable development standpoint. The objective is to effectively guide and harmonise the modifications resulting from social, economic, and environmental processes (Funsten et al., 2020).

When undertaking the restoration of historical gardens, it is imperative to consider the preservation of these cultural legacies, recognising their unique nature as significant entities that provide specific challenges. These issues stem from the inherent reliance of all human-made creations on the natural world, regardless of their quantity. According to Funsten et al. (2020), a garden can be perceived as a mostly cultural construct, where its natural elements are deemed essential but merely constitute a fundamental aspect of the garden. The restoration process involves utilising nature as a tool, starting at the level of plants as a collective entity and extending to the garden as a whole. Similar to the constituent bricks in a structural edifice or the pigments employed in a visual artwork, historical gardens have the capacity to undergo alterations as required while preserving the inherent authenticity of the garden.

Gardens exhibit a lack of stability due to their perpetual transformation over time and throughout the seasons, driven by the cyclical patterns of biological growth and deterioration. Consequently, determining the garden's original form is a challenge. The gardens exhibit exceptional magnitude in relation to several circumstances, including light, temperature, and weather. The aforementioned elements hold significant importance in the context of gardens, and the incorporation of these criteria into the restoration process can lead to the attainment of sustainable outcomes (Funsten et al., 2020).



**Figure 4.** Çağlayan Kasrı, late 19th century (Atasoy, 2015)

Historical gardens can be observed across several dimensions, ranging from the humble domestic garden to the meticulously designed and expansive parkland. A historic garden encompasses more than a mere assemblage of plant life. The environment includes various physical components such as soil, water, rocks, plants, bushes, trees, and man-made structures such as buildings, shelters, or sculptures (Figure 4). The object is expected to undergo visual transformations and may fulfil varying purposes as time progresses. The phenomenon under consideration can be interpreted as the assimilation and contemplation of intangible attributes derived from its immediate environment. It is sometimes denoted as the *genius loci*, which signifies the essence or character of a particular geographic location. Similar to all gardens, historical gardens undergo seasonal variations in their form, hue, and fragrance. In addition to these and analogous natural phenomena, it is imperative to consider the anthropogenic alterations that have transpired throughout the course of time (Clerk, 2015).

In recent years, there has been a growing recognition of the significance of restoring heritage gardens. The gardens in question encompass both community and private gardens, which can be regarded as cultural or social assets. Some of these gardens require restoration and meticulous attention to accurately preserve their historical relevance. The historical gardens encompass a multitude of venerable trees, antiquated plant species, scarce specimens, paved areas, boundaries, and ecological niches. The development of these resources is not an immediate process; it may require a significant amount of time for them to reach maturity and fully embody the designer's original concept. In recent years, there has been a growing recognition of the significance of restoring heritage gardens. The gardens in question encompass both community and private gardens, which can be regarded as cultural or social assets. Some of these gardens require restoration and meticulous attention to accurately preserve their historical relevance. The historical gardens encompass a multitude of venerable trees,



**Proceeding Book of ISESER 2023**

antiquated plant species, scarce specimens, paved areas, boundaries, and ecological niches. The development of these resources is not an immediate process; it may require a significant amount of time for them to reach maturity and fully embody the designer's original concept (Copeland, 2016).

**3. SOME SAMPLES OF HISTORICAL GARDENS AS CULTURAL HERITAGE**

**3.1. Yıldız Palace Gardens, Istanbul, Turkey**

The palace garden, containing some villages and caves, was constructed unplanned, as opposed to the other palaces' gardens. Although many European gardeners are brought and operated, the roads inside the garden, vegetable and fruit gardens, and flowers reflect the character of the Turkish garden, not being too interfered with by nature and being shaped accordingly (Atasoy, 2015).



**Figure 5.** Yıldız Palace Preservation and other sections (Anonym, 2023c).

**3.2. Ihlamur Kasri, Istanbul, Turkey**

Ihlamur Kasri, Istanbul A boundary house has been built for Hacı Hussein's bonds, which is known to be used by the patriarchs for recreation and sports. III. In Selim, swimming pools and sofas were built here in 1791, and in Sultan Abdulmecid, a new landscape arrangement was made for German gardeners. In this rose-filled garden, the lion pool between the two storms was removed, repaired, and reused during restoration in 1978–1985. The little pebble pool on the set was rescued in the same way. (Atasoy, 2015).

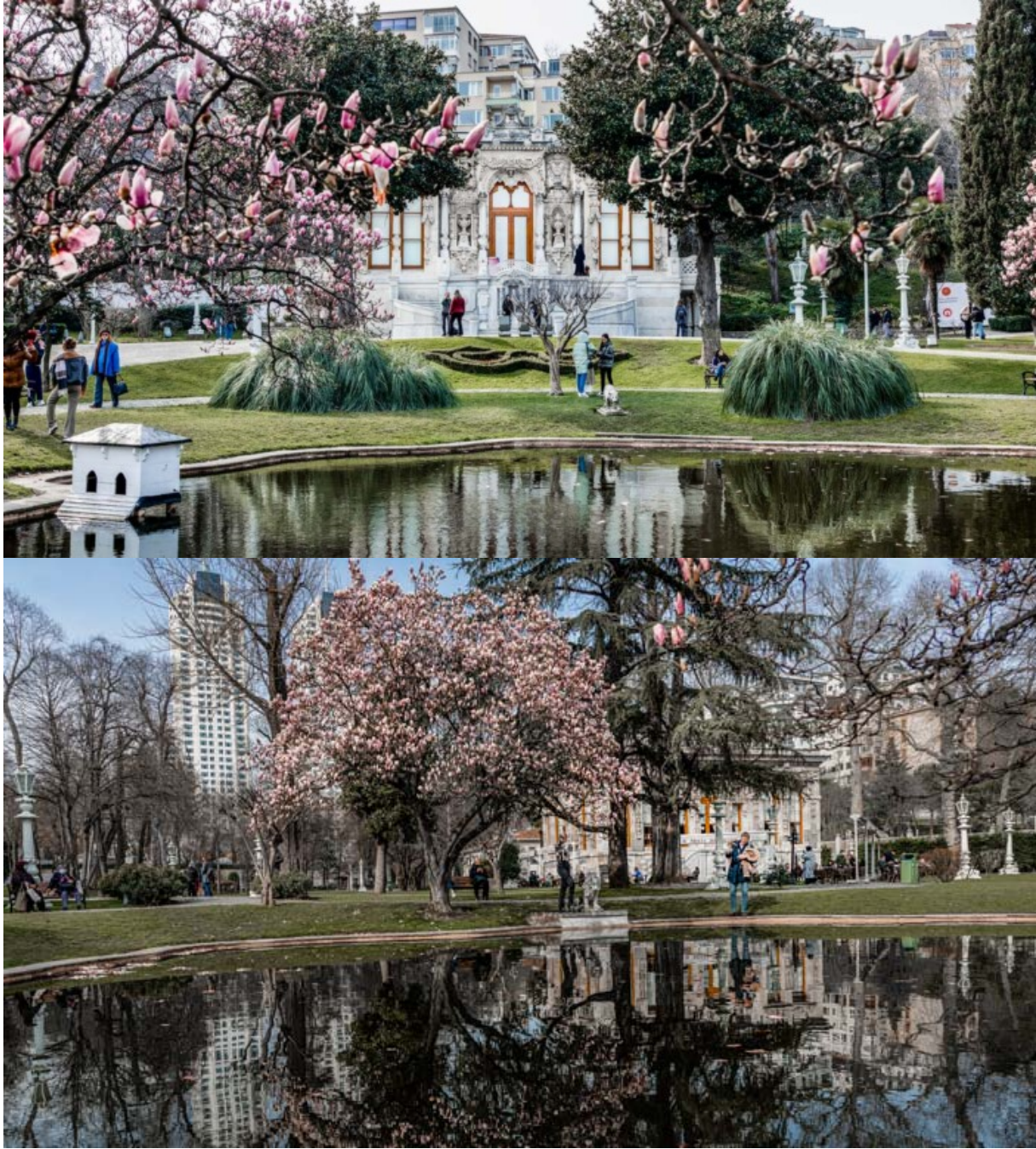

**Figure 6.** Ihlamur Kasrı (Anonym, 2023d)

### **3.3. Beylerbeyi Palace Garden, Istanbul, Turkey**

Today, when you look over the Boaziçi Bridge, you can see how Salamlk and Harem are a wall separating the garden of the Palace of the Beylerbeyi. It is decorated with gardens, flower parks, and animal sculptures, where the views of the Boğaz can be seen in distinct beauty. The top set has a large swimming pool at a depth of 3 metres. Since Sultan Abdülaziz arranged the garden of the new Beylerbeyi Palace for foreign gardeners, which he rebuilt in place of the old Beylerbeyi Palace, this garden appears to be a completely formal garden. The details show the characteristics of Turkish gardens (Atasoy, 2015).



**Figure 7.** Beylerbeyi Palace Garden views (Anonym, 2023e)

### **3.4. Hevsel Gardens, Diyarbakır, Turkey**

With an 8,000-year-old history and continuous agriculture, the Hevsel Gardens are both a stored grain storehouse and a recreational area for the area to be used as needed. It is also an important heritage as a crossroads for cultures because it takes place on the Silk Road route, and the caravans cross the Ten Eyes Bridge and rest in the Hevsel Gardens. (Anonim, 2023d).



**Figure 8.** Hevsel Gardens, (Anonym 2023f)

#### **4. CONCLUSION**

The preservation and upkeep of historic gardens hold significant global importance. Gardens hold significant historical value and serve as a portal to the past. Once lost, the opportunity to recreate them is irrevocably lost. In order to ensure the preservation of this heritage connection, it is imperative to allocate the requisite resources for the purposes of maintenance, repair, or rebuilding, as well as to enhance the acquisition of skills and knowledge. These locations hold significant social value within a progressively urbanised setting. In the event that these historically significant gardens of cultural heritage are subjected to neglect, there is a significant risk of their rapid deterioration and subsequent irreparable loss, rendering their recreation nearly unattainable.

As a result,

- Historical gardens offer different services for the city and the area in which they are located, as well as cultural values.
- To enable them to maintain their long-term sustainability, together with structural restoration or a separate landscape restoration work, a programme could be established for each historic garden or park, taking into account the rules of conservation, regulating access to them, and allowing them to develop as a tourist area.
- Therefore, for the restoration and conservation of historical gardens, which are cultural heritage, as well as other structural architectural heritages, legal and administrative protection decisions must be taken.
- The heritage garden repair, preservation, and restoration plans should be made and must be loyal to the previous things, from the choice of material to the selection of plants, trying to stay true to the original fabric.
- The use of space and its interaction from a sociological point of view should be monitored.
- It has to be documented and archived for future generations.

By taking the simple precautions and applications suggested, the sustainability of historical gardens, which are an important cultural heritage, can be ensured.

#### **REFERENCES**

Anonym, 2023a. Türkiye Unesco Kültür Mirası Diyarbakır Surları, 2015.  
<https://sedatunalkonya.wordpress.com/>

**Proceeding Book of ISESER 2023**

- Anonym, 2023b. John Owen Rees - Dolmabahçe Sarayı Bahçesi. <https://www.facebook.com/EskiZamanlardaIstanbulunEnGuzelFotograflari/posts/2357401274343519/>
- Anonym 2023c. Son Osmanlı Sarayı Yıldız Yerleşkesi. <https://akinci944.com/son-osmanli-sarayi-yildiz-yerleskesi>
- Anonym 2023d. Ihlamur Kasrı. <https://geziotesi.com/ihlamur-kasri-ihlamur-kasirlari-manolya-zamani/>
- Anonim, 2023e Beylerbeyi Saray Bahçesi. <https://i.pinimg.com/originals/f6/22/b4/f622b437c05854cf609f274089e8d263.jpg>
- Anonym, 2023f. Diyarbakır Hevsel Bahçeleri. <https://hevselbahcesi.com/pages/hevsel-bahceleri>
- Atasoy, N. 2015. Antik Çağ'dan XXI. Yüzyıla Büyük İstanbul Tarihi 'İstanbul Bahçeleri'. <https://istanbultarihi.ist/143-istanbul-bahceleri>
- Clerk, N. (2015). Historic Gardens. In The Canadian Encyclopedia. Retrieved from <https://www.thecanadianencyclopedia.ca/en/article/historic-gardens>
- Copeland, N. (2016). Heritage Garden Restoration And Maintenance. Anthony Thake The Pratt Foundation/ISS Institute Overseas Fellowship.
- Czałczyńska-Podolska, M. (2014). Utilization And Preservation Of Historic Gardens And The Development Of Garden Tourism. TECHNICAL TRANSACTIONS ARCHITECTURE, 5-A (10), 132-145. <https://doi.org/10.4467/2353737XCT.14.149.3237>
- Carrari, E., C. Aglietti, A. Bellandi, C. Dibari, F. Ferrini, S. Fineschi, P. Galeotti, A. Giuntoli, R. Manganelli Del Fa, M. Moriondo, M. Mozzo, G. Padovan, C. Riminesi, F. Selvi, M. Bindi. The management of plants and their impact on monuments in historic gardens: Current threats and solutions. Urban Forestry & Urban Greening. Volume 76, 2022, 127727, ISSN 1618-8667, <https://doi.org/10.1016/j.ufug.2022.127727>.  
(<https://www.sciencedirect.com/science/article/pii/S1618866722002709>)
- Funsten C, Borsellino V, Schimmenti E. A Systematic Literature Review of Historic Garden Management and Its Economic Aspects. Sustainability. 2020; 12(24):10679. <https://doi.org/10.3390/su122410679>
- Salwa, M. (2014). Historic Gardens as Places of Conflicting Values. ETHICS IN PROGRESS, 5(1), 96–112. <https://doi.org/10.14746/EIP.2014.1.6>
- Silva, S., & Carvalho, P. (2022, May 26). Historic Gardens Heritage. In Encyclopedia. <https://encyclopedia.pub/entry/23407>
- Unitar, 2023. Sustainable Development Goals, United Nations Institute For Training And Research. <https://unitar.org/about/news-stories/news/social-media-and-web-20-are-key-tools-sdgs>

**O 37. PLANT SELECTIONS FOR EDIBLE GARDENS AND URBAN AGRICULTURE IN  
XERISCAPE LANDSCAPING**

Aslı Güneş Gölbe<sup>1\*</sup>

<sup>1</sup>*İzmir Demokrasi University, Architecture Faculty, Landscape Architecture Department*

E-mail: [asli.gunes@idu.edu.tr](mailto:asli.gunes@idu.edu.tr)

**ABSTRACT:** Due to the current climate crisis, water has become more important than ever before. Drought and the difficulty of accessing clean water have brought to light applications that reduce water consumption. Xeriscape applications are one of the applications that have begun to take their place among landscape architecture studies in this sense. In applications carried out with the xeriscape landscaping concept, plants with low water consumption are used, soil surfaces are covered with mulch applications as much as possible, and ground covers with high water consumption, such as grass, are avoided. These designs reduce water consumption, create spaces with aesthetic value, and enable the emergence of biomass that stores CO<sub>2</sub> against the global climate crisis. The first question of the study is to investigate whether the mentioned Xeriscape applications can be used for purposes other than the mentioned benefits. For this purpose, the usability of urban agricultural practices and edible garden practices that came from the past to the present to maintain the productivity obtained from urban soil surfaces in water-limited applications, that is, xeriscape applications, was investigated. With this approach, the selection of plants that can be used as foodstuffs and the use of selected plants with the xeriscape approach were examined.

*Keywords: Edible Gardens, Urban Agriculture, Xeriscape, Landscape Architecture*

## **1. INTRODUCTION**

The post-World War II industrial revolution, brought about many technological breakthroughs and launched the era of consumer society. With the increased access of human beings to technological tools to sustain their lives by traditional methods, the level of demand for energy has increased and doubled with a high momentum. On the other hand, developments in health care have led to an increase in the human population, which is due to the prolongation of life expectancy while diseases are cured. The high population, the increasing demand for energy, the rapid depletion of natural resources over the potential for regeneration, led to certain constraints. The most important of these reductions is undoubtedly the reduction in freshwater resources and access to clean water. Due to the current climate crisis, water has become more important than ever before. Today humanity is facing with water scarcity.

Water scarcity can mean scarcity in availability due to physical shortage, or scarcity in access due to the failure of institutions to ensure a regular supply or due to a lack of adequate infrastructure (UNWater, 2018). Drought and the difficulty of accessing clean water have brought to light applications that reduce water consumption. Xeriscape applications are one of the applications that have begun to take their place among landscape architecture studies in this sense. Water scarcity and the fear of drought, on the other hand, have raised concerns that precious land surfaces cannot be evaluated efficiently and that food shortages may arise. To this end, landscape applications, where efficiency is central, have begun to range from home gardens to city-wide park applications. In this context, attention has begun to be drawn to urban agriculture practices, where socio-economic activities are at the forefront. Another form of urban tasting practices are small-scale edible gardens. Edible gardens are gardens where traditional agricultural activities involve production for food purposes, highlighting both the aesthetic and the functional beauty of landscape areas.

This study explored the possibilities of integrating xeriscape landscape applications, one of the applications of landscaping architecture, with edible gardening applications, which put water saving at the forefront. The two different concepts included in the landscape studies are to be evaluated together to create sustainable landscapes that support water-saving economics and ecology while increasing efficiency in landscape areas. The study investigated the concepts of dry landscape and edible gardens, highlighted the advantages and disadvantages of both applications, questioned the integration of applications with each other, and suggested plant species that could be used in this regard. The study

## **Proceeding Book of ISESER 2023**

predicts water constraints due to the hot climatic conditions within the Mediterranean climate zone. On the other hand, when we evaluate the data obtained, we have reached the conclusion that there are similar practices in the world, and in our country, these two concepts are used in combination; the studies have not yet been included in the literature.

## **2.XERISCAPE AND EDIBLE GARDEN CONCEPTS**

### **2.1 What is the Xeriscape?**

Xeriscaping is a landscaping which reduce or eliminate the need for irrigation. This means xeriscaped landscapes need little or no water, and it is an alternative source to landscaping in water scare areas (Nirmala and Joythi, 2022). The word xeriscape was first used in the US state of Colorado in 1978 (Çorbacı et al. 2017).

Xeriscape landscaping, often known as xeriscaping, refers to a landscaping approach that is specifically tailored for regions prone to drought or homes that prioritise water conservation. The term "xeriscape" originates from the Greek word "xeros," which translates to "dry," and refers to a landscape characterised by its dry conditions. In essence, xeriscape landscaping is a form of horticulture that relies on a limited water supply for optimal growth and sustainability. Xeriscaping, originally developed for hot and arid areas, has seen significant advancements to extend its applicability to various climate types, particularly those facing water scarcity concerns. Furthermore, xeriscaping techniques are frequently incorporated into landscape designs with comparable aesthetic considerations as conventional gardens (Beaulieu, 2023). They are also, beautiful gardens as seen at the figure 1 as an example of an xeriscaped yard.

The arid landscaping style/xeriscape has seven principles that enable more efficient use of water and save time and money. These basic principles and their explanations are given below:

1. Planning and projecting
2. Soil preparation
3. Appropriate plant selection
4. Creation of grass areas
5. Effective irrigation
6. Use of mulch
7. Proper care (Çorbacı et al. 2017).

The significance of land surveys becomes increasingly pronounced at first by planning and projecting.

(a) The natural data includes information on topography, climate (including cold or hot areas), vegetation (in the east, west, north, and south), areas with varying levels of sunlight exposure, areas with water drainage, soil characteristics, and the current state of vegetation (including its health, naturalness, and suitability to the site conditions).

(b) The cultural data encompasses the identification of functional areas such as land use, hard surfaces, pedestrian pathways, vehicular roads, pools, and other relevant features. Additionally, it involves assessing the visual quality of the area, distinguishing between favourable and unfavourable appearances (Çınar and Kart Aktaş, 2018).



**Figure 1.** A xeriscaped yard in Niwot designed by J&S Landscape. Photo courtesy of J&S Landscape.: (Ufheil and Hunt, 2019)

Prior to implementing xeriscape applications on the yards, it is imperative to do soil studies and preparation, as well as complete the necessary plant selection, as part of the planning and design process. The use of lawn applications should be restricted and should consist of low-water demand grass varieties that are capable of withstanding arid conditions and are compatible with the capacity of the chosen irrigation system. The utilisation of mulch is of great significance in xeriscape applications due to its potential to mitigate evaporation and minimise water loss. Additionally, the establishment of a maintenance programme is essential to ensure the long-term viability of a xeriscape garden.

The benefits of xeriscape landscaping applications can be listed under 10 headings (Simth, 2022).

**1. Conserves water:** Turfgrass requires significantly more water than native plants, many of which may survive without further irrigation. Moreover, hydro zoning lessens overwatering and underwatering by classifying plants according to their water requirements.

**2. Saves money:** You can save up to 80% on your water bills with xeriscaping. Xeriscaping can save you a staggering 87% of your annual lawn care expenses.

**3. Gives you access to financial incentives:** In the USA and Europe, a lot of municipal governments provide homes that want to xeriscape with rebates and reduced bills.

**4. Attracts future buyers:** Xeriscaping is becoming more and more popular as a more environmentally friendly form of landscaping, and it can raise the value of your home by 14%.





**Figure 2.** A xeriscaped home environment example (Yazzie,2023)

**5. Saves time:** Once established, some hardy native plants don't require any watering at all. Other drought-tolerant plants include perennial flowers, succulents, shrubs, trees, and ground coverings. Watering these plants should be done seldom, usually once every two to three weeks.

**6. Promotes biodiversity:** Your xeriscape may provide the home and food supply that many native animals and insects need while their natural habitats are being lost. Beautiful pollinators like birds, bees, and butterflies are drawn to native plants, so your backyard will soon be a vibrant spectacle.

**7. Extends the life of water resources infrastructure:** Reducing water usage contributes to the preservation of aquifers, water treatment facilities, and reservoirs.

**8. Reduces or eliminates chemical needs:** Because native plants utilized in xeriscapes are specifically suited to your area, you won't need to use dangerous pesticides or fertilizers.

**9. Decreases energy use and pollution:** With conserving energy, xeriscaping helps your watershed remain cleaner, consume fewer fossil fuels, and save more water for later.

**10. Gorgeous and fun to gardening:** It may be enjoyable and fulfilling to plant a rock garden, create a wildflower-filled haven with a chair or seat for reading, or construct an edged patio. You never know, your neighbours could be motivated to follow your lead (Simth, 2022).

## **2.2. Edible Garden**

According to Bhatt's study conducted in 2009, edible landscaping exhibits no discernible distinction from conventional landscaping, as it adheres to the same rules and principles during the planning phase.

The design of an edible landscape can rely on it as a sustainable and multipurpose project, while also considering community development programmes, designing schemes, and housing type and design. It is the practise of utilising fruits, vegetables, herbs, and flowers in a manner that extends beyond their aesthetic qualities, encompassing their utility as sources of sustenance, flavour, and visual allure, is commonly referred to as edible landscaping. Edible landscaping presents itself as a viable alternative to conventional landscapes that are primarily dedicated to the cultivation of fruits, vegetables, and herbs for personal consumption. Edible plants have the potential to be cultivated independently or integrated with ornamental species, resulting in aesthetically pleasing arrangements inside preexisting gardens and yards (Fetouh, 2018).



**Figure 3.** Edible Garden Project in University of Minnesota (Greytak et Al. 2019)

The edible garden serves several purposes. These functions, such as production, economic revitalization, energy and waste management, biodiversity support, community socialisation, sociality, public health, cultural heritage, education, and so on, are easily collected (Table 1).

**Table 1.** The purpose and accompanying practises of edible landscaping according to Fetouh, (2018).

<b>FUNCTION</b>	<b>DESCRIPTION AND JUSTIFICATION</b>	<b>SUPPORTIVE PLANNING STRATEGIES</b>
Production	The noncommercial production of food categories inside local communities. Edible landscaping refers to the practise of incorporating food-producing plants into the design and layout of landscapes.	Planning landscapes for sustainable production and resources use efficiency
Energy management	Local food production conserve power consumed during packing, cooling and transportation	Develop transportation systems for efficient food delivering system
Waste management	Recycling organic wastes for compost production and safety food fertilizing	Develop waste collection and composting system for local communities
Biodiversity	Landscape planning can support a various collection of native and imported plant species	Reshaping the distribution of landscape items to add more gardens and farms
Microclimate control	Landscape usually positively modify microclimate through humidity control, wind protection, and shade	Designing edible landscape to allow air movement to avoid climate warming conditions
Economic revitalization	Edible ornamentals offer more jobs in the low-income neighbourhoods	Develop social network to introduce residents to new jobs
Community socialization	Gardening activity and sharing food products enhance socialization among residents	Integration of farming activity along with other social activity
Public health	Free access for fresh fruits and vegetables plus other green spaces usually enhance resident's health and physical activity	Explore opportunities to develop healthy lifestyle through community programming

**Proceeding Book of ISESER 2023**

Cultural heritage	Edible ornamentals can provide access to typical ethnic food that can be very rare for immigrant residents	Providing communities with immigrant population with community edible landscaping
Education	Edible landscaping enables kids and adult to know about food production, crops, nutrition, environment and other cultures	Organizing programs during summer and vacations for gardening activity

**3. EDIBLE GARDEN CONCEPTS FOR XERISCAPE**

Edible garden designs for drought areas or xeric landscaping can be designed by taking into account three different concepts.

**3.1. Mediterranean Gardens**

The vegetative texture of the Mediterranean and its environs is used in this design style, as well as edible herbaceous and woody species, trees and bushes whose fruits or leaves can be eaten or drunk.

Plants that can be used in this garden design style include, olives, figs, pomegranates, oriental persimmon, citrus, grapes, rosemary, oregano, basil, and shrubs strawberry, chamomile, red raspberry, blackberry (Popenoe, 2023)



**Figure 4.** Olive Tree (Doğa Dergisi, 2020)

**3.2. Edible Succulents used Gardens.**

Edible cactus and succulents, which are essential for xeriscape gardening, are chosen and employed in landscaping areas in this design style.

Cacti and succulents that can be used in this design approach include: Opuntia Cactus, Dragon Fruit. Portulacaria afre, Purslane, Yucca flowers, Aloe (Lee Baldwin, 2020).



Figure 5 and 6. *Opuntia cactus* (Anonym, 2023a) and Dragon Fruit (Anonym, 2023b)

### **3.3. Drought Tolerant Herbs and Vegetables used Gardens.**

In this type of design, the design is carried out by taking into account only the drought resistance capacities of the edible plants to be used, without considering any style or region. The primary purpose of this design can be considered as production.

Plants that can be used in this garden design style are.

- **Herbs:** Bee balm, Lavender, Marjoram, Yarrow, Sweet alyssum, Oregano, Thyme, Rosemary, Russian sage, Lamb's ears (Tilley, 2023).



Figure 7. Oregano and Thyme (Anonym, 2023c)

- **Vegetables:** Onions, Broccoli, Cabbage, Spinach, Radish, Beets, Leaf lettuce (Tilley, 2023).



**Figure 8.** Broccoli (Anonym, 2023d.) and radish (Anonym, 2023e)

#### **4. CONCLUSION**

Creating edible gardens for drought-resistant or xeriscape gardens is a very important and precious approach that we can use to produce food under water scarcity conditions in the future. And every fertile square will be important for communal food consumption in the near future because of uncontrolled urban growth.

With this approach, every centimetre of clean soil must be productive in many ways. This study offers a different perspective for drought areas using edible plants while xeriscaping. At the end, using soil from a productive perspective will be more important in the near future, given the global climate crisis.

#### **5. REFERANCES**

- Anonym, 2023a. Opuntia Cactus. Opuntia humifusa (Eastern Prickly Pear) Cactus, Devil's Tongue, Eastern Prickly Pear, Low Prickly Pear. Prickly Pear. <https://www.gardenia.net/plant/opuntia-humifusa-eastern-prickly-pear>
- Anonym, 2023b. Dragon Fruit. <https://www.etsy.com/listing/944870154/dragon-fruit-plant-hylocereus-pitaya>
- Anonym, 2023c. Oregano and Thyme. <https://www.hazelfieldfarm.com/our-online-store/Fresh-Oregano-p333966046>
- Anonym, 2023d. How Do I Grow Broccoli? <https://joegardener.com/how-do-i-grow-broccoli/>
- Anonym, 2023e. Radish. <https://www.castlefarmbishton.co.uk/product/radish/>
- Beaulieu, D. 2023. Guide to Xeriscape Landscaping. How to use xeriscaping to save water and money in arid climates. <https://www.thespruce.com/xeriscape-landscaping-meaning-2131129>
- Bhatt V, Farah LM. 2009. Designing edible landscapes. Open House Int 34:5–7
- Çınar, H.S., Kart Aktaş, N. 2018. Xeriscape Analysis: A Case Study In A Residential Garden In Istanbul. Journal of Environmental Protection and Ecology 19, No 4, 1918–1925.
- Çorbacı, Ö.L, Yazgan, M.E., Özyavuz, M. 2017. Kurakçıl Peyzaj (Xeriscape) ve Uygulamaları. Karakayalar Matbaa. ISBN:978-605-030-618-7. Edirne.
- Doğa Derneği, 2020. Zeytin Ağacı Özellikleri ve Yetiştigi Yerler. <https://www.dogadergisi.com/zeytin-agaci-ozellikleri-ve-yetistigi-yerler/>
- Fetouh, M.I, 2018. Edible Landscaping in Urban Horticulture. © Springer International Publishing AG, part of Springer Nature 2018D. Nandwani (ed.), Urban Horticulture, Sustainable Development and Biodiversity 18, [https://doi.org/10.1007/978-3-319-67017-1\\_7](https://doi.org/10.1007/978-3-319-67017-1_7)
- Greytak, N., Olson, M., Dryke, J., Davis, E., Bartholow, M., Prendergast, C., Schlegel, C., Powell, M. 2019. Creating an Edible Landscape. Instructor: Len Marquart, Associate Professor, Department of Food Science & Nutrition. College of Food, Agricultural, & Natural Resource Sciences. Resilient Communities Project Final Report. University of Minnesota. USA
- Lee Baldwin, D., 2020. Ten Edible Succulents And How To Prepare Them. <https://debraleebaldwin.com/succulent-plants/ten-edible-succulents-and-how-to-prepare/>

**Proceeding Book of ISESER 2023**

- Nirmala, A., & Jyothi, G. 2022. Xeriscaping: A Method of Garden Designing. *Advances in Horticulture Sciences Book* (Volume - 4). (C. 4, Sayı June). <https://doi.org/10.22271/int.book.148>
- Popenoe, J., 2016. Tips For the Perfect Mediterranean Garden. <https://www.dailycommercial.com/story/lifestyle/columns/2016/11/12/popenoe-tips-for-perfect-mediterranean-garden/24564138007/>
- Simith, M. 2022. Benefits of Xeriscaping. <https://lawnlove.com/blog/benefits-of-xeriscaping/>
- Tilley, N. 2023. Gardening Know How: Integrating Vegetables And Herbs Into The Xeriscape Garden. <https://www.gardeningknowhow.com/special/xeriscape/integrating-vegetables-and-herbs-into-the-xeriscape-garden.htm>
- Ufheil, A. and Hunt, N. 2019. The Beginner's Guide to Xeriscaping in Denver. Here's how you can save water without sacrificing greenery. (Photo: A xeriscaped yard in Niwot designed by J&S Landscape. Photo courtesy of J&S Landscape.) <https://www.5280.com/the-beginners-guide-to-xeriscape-in-denver/>
- UNWater, 2018. Water Scarcity [https://www.unwater.org/sites/default/files/app/uploads/2018/10/WaterFacts\\_water-scarcity\\_sep2018.pdf](https://www.unwater.org/sites/default/files/app/uploads/2018/10/WaterFacts_water-scarcity_sep2018.pdf)

**O 38. INVASIVE PLANT SPECIES IN THE URBAN ECOSYSTEM: BOSTANLI STREAM  
EXAMPLE; KARSIYAKA, IZMIR**

Gülşah KAÇMAZ AKKURT<sup>1\*</sup>, Seda ŞEMSIYEÇİ<sup>2</sup>

<sup>1</sup>*Department of City and Regional Planning, Faculty of Architecture, Dokuz Eylül University, Izmir,  
Turkey, ORCID: 0000-0002-1984-5324*

<sup>2</sup>*ORCID: 0000-0002-5930-7774*

E-mail: <sup>1</sup>*gul.sah.k@hotmail.com*, <sup>2</sup>*Sedasemsiyeci@gmail.com*

**ABSTRACT:** Human beings have tended to change the physical environment in which they live since the day they came into existence. One of the results of these changes is the change of flora and fauna. These conscious or unconscious changes cause invasive species to settle in natural habitats. These habitat changes especially threaten the existence of local plant species and may even cause their extinction.

It is important to identify and control these plant species that prevent the provision of ecosystem services by reducing biodiversity in urban landscapes. In addition, when choosing plants in landscape projects, local plant species should be preferred instead of aesthetic concerns or periodic popular choices. In this direction, the aim of this study was to determine the invasive plant species used in the green areas along Bostanlı Stream in Izmir, where exotic plant species are abundant.

*Keywords: Izmir, Bostanlı Stream, Invasive Plant Species, Urban Ecosystem*

## **1. INTRODUCTION**

The increase of invasive species (plant or animal) on Earth is in fact closely related to the history or rise of humankind on Earth. Therefore, to understand the increase of invasive alien species, it is useful to look at recent human history. Some scientists consider the beginning of the period when mankind began to influence the earth as the beginning of agriculture. However, evaluations based on atmospheric data suggest that humans lived in partial harmony with nature until the end of the 18th century, and with the industrial revolution, a new era emerged in which mankind began to use natural resources unbalanced and irresponsibly (Önen, 2015). Today, when population density and urbanisation have reached incredible dimensions, especially with the effect of the development in transportation and communication technology. The earth has become a world of gigantic cities connected to each other by complex networks (communication, energy, transportation, etc.) Urban settlements, which were generally concentrated in regions rich in natural resources before, are now spread almost all over the earth. This situation has eliminated the natural barriers (sea, ocean, mountain ranges, deserts, etc.) between biogeographical (biodiversity) regions of the earth and shortened the distances. Therefore, invasive organisms have become easily transportable to new countries/regions (Önen, 2015).

The International Union for Conservation of Nature and Natural Resources (IUCN) defines alien invasive species (plant or animal) as agents that establish themselves as alien species in natural or semi-natural ecosystems and habitats, threatening and altering natural biodiversity. These plants, which have extremely high resistance, provide superiority to other plant species in the new area they enter due to their genetic diversity, strong growth ability, lack of natural enemies and environmental pressure in the area where they settle. The invasion processes of invasive alien plant species generally include settlement, spread and invasion stages. Invasive plant species increase their populations in the areas they spread in a short time and become dominant. In the past, these species were mostly used to cover problematic areas (such as dam edges, mining areas, marsh drying areas, erosion control areas, etc.) with plants as soon as possible. However, as time passed, they spread from the area where they were planted to natural areas and destroyed the natural vegetation and local plant compositions (Sarı, 2019).

Invasion of natural ecosystems by invasive species is a major threat to biodiversity globally. Many researchers have argued that invasive plants negatively affect ecosystem structure and functioning in all habitats by reducing native species richness, altering water and fire regimes, soil nutrient status and geomorphological processes (Lake and Leishman 2003). Furthermore, the Millennium Ecosystem

**Proceeding Book of ISESER 2023**

Assessment (2005) recognized biological invasions as one of the five main causes of biodiversity decline, which translates into a reduction in ecosystem services worldwide.

Strategies and approaches have been developed in many parts of the world to restore ecosystems following degradation caused by invasive species. From interventions that aim to reduce the presence, abundance or impacts of invasive species and favor native species, to low-impact practices that involve only the removal or reduction of invasive species (Holmes et al., 2000). Among these methods, mitigation efforts based on the elimination of invasive species have created dilemmas in some cases. The most well-known example is the use of invasive Tamarix species in the USA as habitat for endangered flycatchers (*Empidonax traillii* subsp. *extimus*). These birds, which are known to be extremely rare throughout the country, have not been seen in the area dominated by Tamarix until now, but are known to be present there. This has created a dilemma as to whether the coastal ecosystem, which is more conducive to the sustainability of essential ecosystem services, or flycatchers should be prioritized (Pysek and Richardson, 2010).

As in many parts of the world, many ornamental plants with invasive characteristics are intensively used in green areas designed for urban development in Turkey. The number of studies on the identification and control of these plants, which are likely to damage natural ecosystems by spreading from urban landscapes to natural landscapes, should be increased.

Within the scope of this study; invasive plant species used in the green areas along the Bostanlı Stream in Karşıyaka district of İzmir province in the Aegean Region of Turkey were examined. In addition, the environmental and economic damages caused by these plants in İzmir province were also mentioned.

**2. MATERIAL AND METHOD**

This study was conducted in the vicinity of Bostanlı Stream in Bostanlı neighborhood of Karşıyaka district of İzmir Province (Figure 1).



**Figure 1.** Research Area Boundary

In the city of İzmir, there are often streams through the residential landscape. The immediate surroundings of these concreted streams are mostly built up. Some of them are surrounded by green



**Proceeding Book of ISESER 2023**

areas, such as the stream subject to our research (Figure 2). The area subject to the research is the 1,1 km section of Bostanlı stream extending from Demirköprü Underpass to Hasan Ali Yücel Boulevard.

In the first stage of the research, the natural vegetation and characteristics of İzmir province were investigated. In the second stage, the plant species used in the landscape design of Bostanlı Stream were identified. In the last stage of the study, invasive plant species used in the research area were identified.



**Figure 2.** General View of the Study Area (Original, 2023)

**3. RESEARCH FINDINGS**

In the research findings, the presence of invasive plant species in the green areas around Bostanlı Stream in Bostanlı neighborhood of Karşıyaka district of İzmir province was evaluated. Approximately 70 different plant species were identified in the area and these species were grouped as deciduous/palm trees and shrubs, deciduous shrubs, evergreen trees, evergreen shrubs, ivy and ground cover species. As a result of the evaluations, it was determined that approximately 35% of these species consist of invasive and high-invasive plant species (Figure 3).

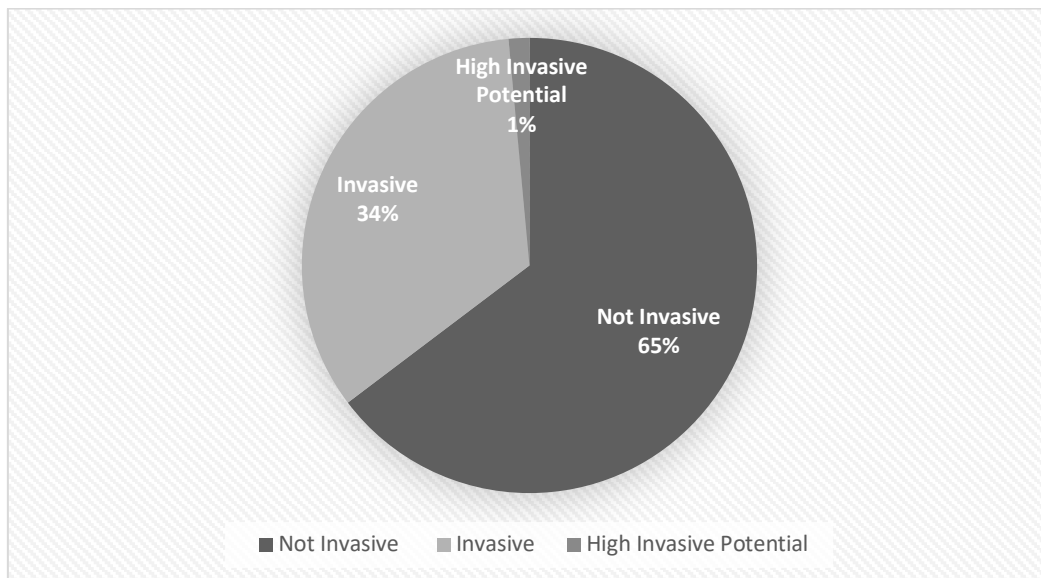

**Figure 3.** Rate of invasive plant species in the research area

**Proceeding Book of ISESER 2023**

Approximately 35 different deciduous and evergreen tree species were identified in the area (Table 1). According to the data obtained, *Robinia pseudoacacia*, *Acer negundo*, *Albizia julibrissin*, *Paulownia tomentosa*, *Olea europea*, *Nerium oleander*, *Laurus nobilis*, *Hibiscus syriacus*, *Eucalyptus camaldulensis*, *Morus alba*, *Prunus persica*, *Populus nigra*, *Phoenix canariensis*, *Chamaerops excelsa* were identified as invasive species and *Robinia pseudoacacia* "*Umbracifera*" was identified as potentially invasive species. The proportion of these species in the area in relation to all evergreen tree and shrub species is quite high at 43%. These species can encircle the area very quickly and cause undesirable designs. In addition, the proportion of exotic plant species in the area is also quite high (Table 1).

**Table 1.** Invasiveness assessment of deciduous/palm trees and shrubs species in the study area

No	Latin Name	Family	Homeland	Invasive	High Invasive Potential	Not Invasive
1	<i>Robinia pseudoacacia</i> "Umbraculifera"	Leguminosae	North America		X	
2	<i>Robinia pseudoacacia</i>	Leguminosae	Southeast America	X		
3	<i>Fraxinus angustifolia</i>	Oleaceae	Middle and Southern Europe and North Africa and Southwest Asia			X
4	<i>Platanus orientalis</i>	Platanaceae	Eurasia, Balkans			X
5	<i>Robinia hispida</i>	Leguminosae	Southeast America			X
6	<i>Acer negundo</i>	Aceraceae	North America	X		
7	<i>Schinus molle</i>	Anacardiaceae	Middle and South America			X
8	<i>Jacaranda mimosifolia</i>	Bignoniaceae	Brazil			X
9	<i>Tilia cordata</i>	Malvaceae	Europe			X
10	<i>Liquidambar orientalis</i>	Altingiaceae	Anadolu			X
11	<i>Paulownia tomentosa</i>	Paulowniaceae	China	X		
12	<i>Hibiscus syriacus</i>	Malvaceae	Asia	X		
13	<i>Catalpa bignonioides</i>	Bignoniaceae	North America			X
14	<i>Bauhinia variegata</i>	Leguminosae	China			X
15	<i>Punica granatum</i>	Lythraceae	Near East Asia			X
16	<i>Eucalyptus camaldulensis</i>	Myrtaceae	Australia	X		
17	<i>Chamaerops excelsa</i>	Arecaceae	China and Japan	X		
18	<i>Prunus cerasifera</i> "Atropurpurea"	Rosaceae	North America			X
19	<i>Morus nigra</i>	Moraceae	China Japan, Thailand Malaysia			X
20	<i>Morus alba</i>	Moraceae	Turkey, Iran, Arabia, Caucasus	X		

**Proceeding Book of ISESER 2023**

21	<i>Prunus armeniaca</i>	Rosaceae	Central Asia			X
22	<i>Prunus persica</i>	Rosaceae	East Asia and China	X		
23	<i>Olea europaea</i>	Oleaceae	From the Mediterranean and Africa, Central Asia and Australia	X		
24	<i>Populus nigra</i>	Salicaceae	Europe, Southwest and Central Asia, Turkey	X		
25	<i>Ficus nitida</i> 'Retusa'	Moraceae				X
26	<i>Ceratonia siliqua</i>	Leguminosae	Eastern Mediterranean and its coasts			X
27	<i>Washingtonia filifera</i>	Arecaceae	Southwestern America and Northwestern Mexico			X
28	<i>Prunus serrulata</i>	Rosaceae	Japan			
29	<i>Gleditsia triacanthos</i>	Leguminosae	North America			X
30	<i>Albizia julibrissin</i>	Leguminosae	The tropics of Asia	X		
31	<i>Nerium oleander</i>	Apocynaceae	Mediterranean Region	X		
32	<i>Laurus nobilis</i>	Lauraceae	Anatolia and the Balkans	X		
33	<i>Cydonia oblonga</i>	Rosaceae	North - Western Iran, North Caucasus, the shores of the Caspian Sea and Northern Anatolia			X
34	<i>Phoenix canariensis</i>	Palmae	Tropical and Subtropical Africa-Canary Islands	X		
35	<i>Magnolia grandiflora</i>	Magnoliaceae	North America			X

In the area, 24 different deciduous shrub species were identified (Table 2). Among these species, *Nandina domestica*, *Ligustrum japonicum*, *Agave americana*, *Pyracantha coccinea*, *Lantana camara*, *Berberis thunbergii* "Atropurpurea" were identified as invasive species. Although these species constitute 25% of all deciduous shrub species in the area, they cover a large area due to their invasive characteristics.

**Table 2.** Invasiveness assessment of deciduous shrub species in the study area

No	Latin Name	Family	Homeland	Invasive	High Invasive Potential	Not Invasive
1	<i>Nandina domestica</i>	Berberidaceae	India, China and Japan	X		

**Proceeding Book of ISESER 2023**

2	<i>Solanum laciniatum</i>	Solanaceae	America			X
3	<i>Euryops pectinatus</i>	Asteraceae	South Africa			
4	<i>Viburnum lucidum</i>	Caprifoliaceae	Southeast Europe, Mediterranean coast			X
5	<i>Pittosporum tobira</i>	Pittosporaceae	Southeast Asia and Australia.			X
6	<i>Euonymus japonica 'Aurea'</i>	Celastraceae	Japan, Korea and China			X
7	<i>Seneraria cineraria</i>	Asteraceae	Mediterranean Region Southern and Central Europe			X
8	<i>Ligustrum japonicum</i>	Oleaceae	Japan and Korea	X		
9	<i>Agave americana</i>	Agavaceae	America	X		
11	<i>Westringia fruticosa</i>	Lamiaceae	Australia			X
12	<i>Yucca filamentosa</i>	Agavaceae				X
13	<i>Campsis radicans</i>	Bignoniaceae	South America			X
14	<i>Abelia grandiflora</i>	Caprifoliaceae	China			X
15	<i>Pyracantha coccinea</i>	Rosaceae	Southern Europe and Anatolia	X		
16	<i>Euonymus japonicus</i>	Celastraceae	Japan, China, Korea			X
17	<i>Lantana camara</i>	Verbenaceae	America	X		
18	<i>Santolina chamaecyparissus</i>	Asteraceae	Western Mediterranean, Turkey			X
19	<i>Cotoneaster microphyllus</i>	Rosaceae	Asia, Europe and Africa			X
20	<i>Viburnum tinus</i>	Caprifoliaceae	Ukraine, Russia, Southeast Asia, South Africa			X
21	<i>Berberis thunbergii "Atropurpurea"</i>	Berberidaceae	Southern Japan	X		
22	<i>Callistemon leavis</i>	Myrtaceae	South East Australia			X
23	<i>Ligustrum ovalifolium</i>	Oleaceae	Europe, North Africa, Asia Australia, China and Japan			X
24	<i>Hibiscus mutabilis</i>	Malvaceae	Güney Çin			X

Four different evergreen tree species were identified in the area (Table 3). As a result of the evaluations, there are no invasive species or species with invasive potential among the evergreen species.

**Proceeding Book of ISESER 2023**

**Table 3.** Assessment of evergreen tree species in the study area in terms of invasiveness

No	Latin Name	Family	Homeland	Invasive	High Invasive Potential	Not Invasive
1	<i>Thuja orientalis</i>	Cupressaceae	East Asia			X
2	<i>Cupressus arizonica</i>	Cupressaceae	Mexico, Arizona.			X
3	<i>Cupressus macrocarpa</i>	Cupressaceae	Western America			X
4	<i>Pinus brutia</i>	Pinaceae	Eastern Mediterranean Basin			X

As a result of the surveys, 2 different evergreen shrub species were identified in the area (Table 4). As a result of the assessments, there are no invasive species or species with invasive potential among the evergreen species.

**Table 4.** Invasiveness assessment of evergreen shrub species in the study area

No	Latin Name	Family	Homeland	Invasive	High Invasive Potential	Not Invasive
1	<i>Juniperus horizontalis</i>	Cupressaceae	Alaska, Canada, North America			X
2	<i>Juniperus sabina</i>	Cupressaceae	Central and Southern Europe, Alps, Carpathians, Pyrenees, Turkey, Caucasus and Siberia			X

Finally, as a result of the observations, 6 different ground cover and ivy species were identified in the study area (Table 5). Among these species, *Parthenocissus quinquefolia*, *Carpobrotus acinaciformis* and *Hedera helix* were identified as invasive species. Since 50% of all ground cover and ivy species in the area are invasive, these species occupy more space in landscape design than other species.

**Table 5.** Invasiveness assessment of ground cover and ivy species in the study area

No	Latin Name	Family	Homeland	Invasive	High Invasive Potential	Not Invasive
1	<i>Parthenocissus quinquefolia</i>	Vitaceae	North America	X		
2	<i>Mesembryanthemum nodiflorum</i>	Aizoaceae	South Africa			X
3	<i>Carpobrotus acinaciformis</i>	Aizoaceae	South Africa'	X		
4	<i>Bougainvillea alexandra</i>	Bougainvillea	South America			X
5	<i>Tecomaria capensis</i>	Bignoniaceae	South Africa			X
6	<i>Hedera helix</i>	Araliaceae	Europe and Southwest Asia, Turkey	X		

Proceeding Book of ISESER 2023

4. CONCLUSIONS

Invasive species are an important driver of global change, causing biodiversity loss, ecosystem degradation and reduced ecosystem services worldwide.

The detrimental effects of invasive plant species are now widely recognized and multi-scale programs are being implemented in many parts of the world to mitigate their current and future impacts. Among the activities that have received the most attention and hold the most promise for reducing problems are new approaches to early detection and remediation.

For this purpose, it is an important criterion to pay attention to whether they are invasive and natural or not, as well as their aesthetic functions when selecting plants to be used in urban landscapes. These species, which threaten the sustainability of natural ecosystems by encompassing the area they are found very quickly, should be carefully considered in their areas of use. For this reason, the use of natural plant species should be encouraged in landscape designs, especially in urban landscapes.

As can be seen as a result of the field studies carried out in the green areas around Bostanlı Stream, invasive plant species such as *Robinia pseudoacacia*, *Acer negundo*, *Albizia julibrissin*, *Paulownia tomentosa* are widely used in urban landscapes in İzmir province. When using these species in landscape designs, their invasive character should be taken into consideration and their use should be limited. In addition, a comprehensive database of invasive plant species and diversity should be established throughout the country and the population of these species should be controlled.

REFERENCES

- Holmes, PM., Richardson, DM., Van Wilgen, BW., Gelderblom, C., 2000, Recovery of South African fynbos vegetation following alien woody plant clearing and fire: implications for restoration. *Austral Ecol.* 25:631–39
- Lake, JC. and Leishman, MR., 2003, Invasion success of exotic plants in natural ecosystems: the role of disturbance, plant attributes and freedom from herbivores. *Biol Conserv* 117: 215–226
- Millenn. Ecosyst. Assess., 2005, Millennium Ecosystem Assessment Synthesis Report. Washington, DC: Island
- Önen, H., 2015, İstilacı Yabancı Türler ve İstila Süreçleri (Invasive Alien species and invasion process), Türkiye İstilacı Bitkiler Kataloğu ( Invasive Plants Catalogue Of Turkey), Publisher: T.C. Gıda, Tarım ve Hayvancılık Bakanlığı Tarımsal Araştırmalar ve Politikalar Genel Müdürlüğü Bitki Sağlığı Araştırmaları Daire Başkanlığı.
- Pysek, P. and Richardson, DM., 2010, Invasive Species, Environmental Change and Management, and Health
- The Annual Review of Environment and Resources, 35:25–55, 10.1146/annurev-environ-033009-095548
- Richardson, D. M., Cowling, R. M. and Le Maitre, D. C., 1990, Assessing the risk of invasive success in Pinus and Banksia in South African mountain fynbos. *J. Veg. Sci.* 1, 629–42.
- Sarı, D., 2019, Kentsel Peyzajda Kullanılan Bazı İstilacı Süs Bitkileri; Türkiye’den Örnekler, Scientific Developments - Chapter 12, ISBN: 978-605-78521-20
- Wiser, S. K., Allen, R. B., Clinton, P. W. and Platt, K. H., 1998, Community structure and forest invasion by an exotic herb over 23 years. *Ecol.* 79, 2071–81.

**O 39. EFFECT OF SALINE SOILS AND WATER QUALITY ON SOME COTTON TRAITS  
UNDER DIFFERENT LOCATIONS**

E. H. El-Seidy<sup>1\*</sup>, S. A. Shaker<sup>2</sup>, Hanan El- Ganayny<sup>2</sup>

<sup>1</sup>*Agron. Dep., Fac. Agric., Tanta Univ.*

<sup>2</sup>*Cotton Res. Inst., Agric. Res. Center, Giza, Egypt*

E-mail: *drsayed176@gmail.com, Emannabel923@gmail.com, shroukhassan1998@gmail.com*

**ABSTRACT:** The main objectives of this study have been conducted to evaluate the effect of different locations as affected by salinity on yield and some yield components for cotton varieties. Field conditions vary from location to another as affected by soil salinity and water quality so, the gene expression differs accordingly to this condition. The seven varieties in this study were evaluated from Extra-long staple category (Giza 87, Giza 88, Giza 92, Giza 93 and Giza 96) and the long staple category (Giza 86 and Giza 94) and these varieties were grown at seven locations in Lower Egypt (Delta) over the two growing seasons of 2013 and 2014 in a randomized complete block design with four replications. Variance components over locations was calculated for earliness, cotton yield and yield components. Kafr Saad location recorded the desirable traits i.e. seed cotton yield (kf), Lint cotton yield (kf), boll weight (g), seed index (g) and lint index (g). Effect of locations were significant for all studied characters. Alexandria location more early than the other locations, also Damietta location recorded the best values for most studied traits.

*Keywords: Location, Soil Salinity and Irrigation Water Quality*

## **1. INTRODUCTION**

Arid and semiarid regions of the world are being faced by soil salinization which is hampering crop growth in these areas (Ghulam *et al.*, 2013). Soil salinity causes great losses to agriculture by lowering the yields of various crops, especially cotton. Salinization of soil creates extremely unfavorable conditions for plant growth. Salt tolerance of plants is linked way connected with light tolerance. All genotypes do not respond in a similar way to changes of the environment, therefore screening of genotypes for stability under varying environmental conditions has thus become an essential part of modern breeding programmers. Soil salinization is one of the important biotic stress which results in the reduction of growth and productivity of the crops (Sairam *et al.*, 2002). It affects crops mainly in two ways i.e. either by osmotic effect or by specific ion effect (Munns and James, 2019). Higher levels of soluble salts in soil mainly cause an increase in osmotic pressure; consequently, plants are impeded to uptake water and nutrients from the soil (Abrol *et al.*, 1988). Osmotic effect causes disruption in osmotic potentials, were as specific ion effect causes toxicity of different ions (Brady and Weil, 2002). High salt concentrations disturb the ionic homeostasis and produce reactive oxygen species (Saqib *et al.*, 2008). It has been observed that in saline soils, the concentration of Na<sup>+</sup> and Cl<sup>-</sup> is higher accompanied with the decreased concentration of K<sup>+</sup> and Ca<sup>2+</sup>: Na<sup>+</sup> ratio thus severely affecting the plant growth (Saqib *et al.*, 2004). The studies about the effects of saline water irrigation on crops mainly focused on various plant growth parameters and grain yield. (Song *et al.*, 2016) showed that the salinity of saline water at 2 g. L<sup>-1</sup> would promote the accumulation of cotton dry matter, but the accumulation of dry matter decreased with the increasing of irrigation water salinity when the salinity was above 4 g. L<sup>-1</sup>. With saline soil irrigation, soil salinity used to be one of the major considerations. The influence of saline water irrigation on soil salinity concentrated on soil salt accumulation/desalinization (Jingang *et al.*, 2019).

The main objectives of this study have been conducted to assess the effect of different locations as affected by salinity on yield and some yield components for cotton.

## **2. MATERIALS AND METHODS**

The materials used in the present investigation included seven Egyptian cotton varieties, (*G. barbadense* L.) belonging to the two categories: (1) Long staple, i.e. Giza 86 and Giza 94 and (2) Extra long staple, i.e. Giza 87, Giza 88, Giza 92, Giza 93 and Giza 96.

**Proceeding Book of ISESER 2023**

Field experiments were carried out to evaluate of seven genotypes at seven different locations in the North of Egypt i.e, Alexandria, El-Behera (Dammhour and Edko), Kafr El-Sheikh (Kafr El-Sheikh and Sedi Salem) and Damietta (Kafr Saad and Kafr El-Batekh) during the two growing seasons 2013 and 2014. The experimental design was a complete randomized block design with four replications. The sowing date was in the second week of April for both seasons. The plot size was 52 m<sup>2</sup>, 65 cm apart ridges and 25 cm between hills.

**2.1. The studied characters were as follows:**

**- Earliness measurements:**

$$\text{Earliness \% (Ear \%)} = \frac{\text{Weight of seed cotton yield in the first pick}}{\text{Weight of seed cotton yield in the two picks}} \times 100 \quad .1$$

2. Position of the first fruiting node (FFN): The node number on the main stem giving the first fruiting branch according to Richmond and Radwan (1962).

**- Yield and yield components:**

Seed cotton yield (SCY) (K/F), Lint cotton yield (LCY) (K/F), Boll weight (BW) (g), Lint percentage (LP) (%), Seed Index (SI).and Lint index (LI) (g).

**2.2. Statistical analysis:**

The standard analysis of variance was computed for each experiment, combined analysis for locations was done according to Snedecor and Cochran (1982). Before calculating, the combined analysis a Bartlett test, 1937 for the homogeneity of error mean squares for the fourteen environments was calculated. Differences among means were tested by Duncan's multiple range tests.

Table (1):Mean chemical analysis values of soil profile under different locations before cotton planting (2013 and 2014 seasons)

Loc.	pH 1:2.5	EC dS/m	SAR	ESP	Cations				Anions			
					Na <sup>+</sup>	Ca <sup>++</sup>	Mg <sup>++</sup>	K <sup>+</sup>	CO <sub>3</sub> <sup>=</sup>	HCO <sub>3</sub> <sup>=</sup>	Cl <sup>-</sup>	SO <sub>4</sub> <sup>=</sup>
Alexandria	8.22	4.63	10.53	12.45	31.50	7.40	10.20	0.37	-	2.17	25.43	21.87
Damanhour	8.16	5.30	11.32	13.35	36.03	8.47	11.67	0.43	-	3.17	28.23	25.20
Edko	8.05	5.48	12.36	14.51	37.27	11.50	6.57	0.83	-	4.50	27.73	23.9
Kafr El-Sheikh	8.22	5.58	11.60	13.67	37.90	8.93	12.30	0.57	-	4.67	30.20	24.83
Sedi Salem	8.21	6.30	12.32	14.43	42.80	10.07	13.87	0.47	-	6.17	33.00	28.03
Kafr Saad	8.28	6.95	12.98	15.05	47.23	11.10	15.27	0.80	-	6.85	36.77	30.78
Kafr El-Bateikh	8.11	4.59	10.53	12.78	31.20	7.33	10.10	0.37	-	2.33	25.83	20.83

**Location:** In this study, we used locations differed in type of soils and quality of irrigation water.

**Soil samples:** Before the treatments layout random soil samples (0-30, 30-60 and 60-90 cm depth) were collected and composite (Table 1) composite soil samples were dried, sieved through 2 mm mesh for the following analysis:

**Soil analysis:**

- Soil reaction (pH) was measured in 1:2.5 soil: water suspension according to **Cottenie et al. (1982)**.



**Proceeding Book of ISESER 2023**

- **Electrical conductivity (ECe)** was measured by electrical conductivity meter model Jenway, 4320 as dS/m at 25°C in soil paste extract according to **Page (1982)**.
- **Soluble calcium and magnesium** in soil paste extract were determined by using versenate method (**Page, 1982**).
- Soluble sodium and potassium were estimated by a Flame Photometer (**Page, 1982**).
- Soluble carbonate and bicarbonate were determined by titration with a standard HCl solution (**Page, 1982**).
- Soluble chloride was determined by titration with a standard silver nitrate solution (**Page, 1982**), and sulphate were calculated by the difference between the sum of soluble cations and anions.
- Exchangeable sodium percentage (ESP) was calculated according to **Gazia (2001)**:  $ESP = -0.9943 + 1.4107 (SAR) - 0.0133 (SAR)^2$

**Criterion of soil salinity**

It was calculated according to **Richards (1969)** are shown in Table (2).

Table (2): Criterion soil salinity.

Soil	Saline	Sodic	Saline-sodic
EC (dS/m)	>4	<4	>4
ESP%	<15	>15	>15
pH	<8.5	>8.5	>8.5 (rarely)

Table (3):

Location	pH 1:2.5	EC dS/m	SAR	Cations				Anions			
				Na <sup>+</sup>	Ca <sup>++</sup>	Mg <sup>++</sup>	K <sup>+</sup>	CO <sub>3</sub> <sup>=</sup>	HCO <sub>3</sub> <sup>=</sup>	Cl <sup>-</sup>	SO <sub>4</sub> <sup>=</sup>
Alexandria	8.11	1.35	6.15	9.2	2.8	1.6	0.7	-	2.5	7.4	4.4
Damanhour	7.89	0.55	3.61	3.70	0.90	1.20	0.20	-	1.50	2.60	1.80
Edko	8.05	1.32	5.69	9.00	2.10	2.90	0.60	-	2.50	6.30	5.80
KafrElSheikh	7.91	0.61	3.82	4.10	1.00	1.30	0.20	-	1.50	2.90	2.30
Sedi Salem	7.98	0.95	4.84	6.50	1.50	2.10	0.20	-	1.50	4.50	4.20
Kafr Saad	7.95	0.78	4.40	5.30	1.20	1.70	0.20	-	1.50	3.70	3.30
Kafr ElBateikh	8.23	1.51	6.10	10.30	2.40	3.30	0.50	-	2.00	7.20	7.30

**Water quality criteria:**

It was calculated according to **Eaton (1950)**, **Doneen (1954)** and **Richards (1969)**, are shown in Table (4).

**Table (4): Water quality criteria**

Criterion	Low	Medium	High	Very high
EC (dS/m)	0.1-0.25	0.25-0.75	0.75-2.25	>2.25
Ppm	64-160	160-480	480-1440	>14.40
SAR	0-10	10-18	18-26	>26
RSC, meq/L	<1.25	1.25-2.50	>2.50	
Na%	<60	60-75	>75	
B, ppm	<0.5	0.5-2.0	>2	
Cl <sup>-</sup> , meq/L	<5	5-10	>10	

Sodium adsorption ratio (SAR) was measured according to the following formula

$$SAR = \frac{Na}{\sqrt{\frac{Ca + mg}{z}}} \text{ ions in meq/L}$$

Where:

## Proceeding Book of ISESER 2023

SAR = Sodium adsorption ratio

$\text{Na}^+$ ,  $\text{Ca}^{++}$  and  $\text{Mg}^{++}$  are the concentrations of ions in meq/L

RSC =  $(\text{CO}_3^- + \text{HCO}_3^-) - (\text{Ca}^{++} + \text{Mg}^{++})$  ions in meq/L

Where

Residual sodium carbonate (RSC) was measured according to the following formula

$$RSC = Na\% = \frac{Na^+}{Ca^{++} + Mg^{++} + Na^+} \times 100$$

Where:

Na% = Sodium percentage

## 3. RESULTS AND DISCUSSION

### 3.1. Soil and water analysis:

Chemical analysis values of soil profile and irrigation water under seven locations are tabulated in Tables (1 and 3) and data of soil salinity and water quality are presented in Tables (2 and 4). The salt tolerance of plants is a very acute problem in agriculture. It attracted the attention of many investigators and practical agricultural workers because of the need to increase yields in saline soils and to develop and utilize new saline areas Esawy *et al.*, (2019) and Jingang Li *et al.*, (2019). As shown in Tables (1 and 2), soils are considered good soils if the EC is less than 4 mmhos and pH 7. But, if the EC is more than 4 mmhos the soil is high saline soils and the sensitive crops are affected. The soil is considered as moderate saline if the EC is less than 4 mmhos and pH less than 8.5 accompanied with the exchangeable sodium less than 15 (Table 2). In the various localities under study, the EC ranged between 4.59 (Kafr El-Batiekh) and 6.95 (Kafr Saad). These soils are considered as moderate saline. Some soils seem to be good soils as the EC is about 4, some other soils are moderate or high saline soils when the EC was more than 4. Field conditions vary from location to another, not only in soil salinity, but also in soil chemical properties such as sodicity, high pH and EC interaction between them. Cotton is considered as moderate affected with moderate salinity. Cotton gives full yield (100%) at EC 7.7 and EC of irrigation water 5.1 and the yield is affected to 50% at soil salinity at EC 17.

At locations of the study, EC ranged between 4.59-6.95 and considered as moderate saline soils. Due to the effect of high concentrations of salts in the soil, the relation of the plants to its environment is changed. For example, such factors as temperature and light, which have a favorable effect under normal conditions, may exert an unfavorable effect under saline conditions (Stragonov, 1964).

Apparently, under extremely adverse conditions, which are often met on saline soils, the effect of salt on the plant is expressed by a change of the state of the protoplasm in cells, as a result of the effects of the salts, the protoplasm retreats from the cell wall. This causes a destruction of the plasmodesmata and a disturbance of the intercellular connections between some of the cells.

In general, saline soils induce a retraction of the protoplasm from the cell wall, and that as a result intercellular connection are broken. When the substrate is desalinized, the normal and condition of the protoplasm is restored, including intercellular connections, and this provides evidence for the reversibility of the process.

Under conditions of our study, EC of irrigation water at Kafr El-Batteikh was the highest value (1.51), followed by Alexandria with value (1.35) and Edko with value (1.32). Relatively, the other locations were non saline water that did not reach more than 0.95 EC (Tables 3 and 4). The decreases under Kafr El-Batekh location, may be due to the toxic effect of salts on the somatic cells of the reproductive organs of cotton is the cause of the stunting of the flower, ovaries and bolls. These causes may be due to the highest EC (1.51 dS/m) and pH (8.23) in water quality under Kafr El- Batekh location (Table 4). These results agreed with Saqib *et al.*, 2004 who stated that in saline soils, the concentration of  $\text{Na}^+$  and  $\text{Cl}^-$  is higher accompanied with the decreased concentration of  $\text{K}^+$  and  $\text{K}^+$ :  $\text{Na}^+$  ratio thus severely affecting the plant growth.

This view is supported by the findings that, with few exceptions, the carbohydrate content and content of nitrogenous compounds is usually higher in plants from saline soils than in the same species of plants from non-saline soils. Apparently in such plants, the accumulation of carbohydrates and nitrogenous substances is more rapid than their utilization for the formation of new cells and tissues. It may be assumed that under conditions favorable for growth, these substances accumulate as storage

**Proceeding Book of ISESER 2023**

products in the plant organs. When the salt concentration of the soil decreases and the conditions for growth are improved, the carbohydrates and nitrogenous substances are rapidly utilized for the formation of new organs. Such a concept can satisfactorily explain the periodicity of growth of plants grown on irrigated saline soils.

Although all localities are in the range of medium salinity, Kafr El-Bateikh gave the lowest yield of seed cotton, lint cotton and boll weight due to high EC of irrigation.

Strogonov (1964) stated that the movement of minerals from the root into the aerial organs of the plant is *via* phloem when the salt content of the plant is low, while, when the salt content is high, the movement is through the xylem, in the transpiration stream. Under saline conditions, the saturation of plant tissues with salts takes place very rapidly; the further absorption of minerals is determined by the rate of transpiration. The role of transpiration increases when the root system, due to salt damage, loses its regulation ability and non-nutrient salts, dragged in by the transpiration stream, accumulate in the organs of the plant. It can be seen that, the growth and development of cotton on saline soils depends not so much on the total salt content, but on the ratio between the different salts in the soil. The type of salinity in the soil determines the rate of growth and development of the plant.

Unfavorable effects of salts are accompanied by disturbances, in the plant tissues, of the normal balance between the basic mineral nutrient elements.

Soil salinity causes an unfavorable balance between potassium and calcium. The excess of easily soluble salts in the soil affects unfavorably the absorption of nutrient substances by the plant. The opinion of these investigators is that the plant, apart from salt poisoning, also suffers from hunger for essential nutrients.

Seed cotton and lint yields were affected at Kafr El-Sheikh and Sedi Salem less than Kafr Saad, Damanhour, Edko and Alexandria due to the high EC for soils. At Kafr Saad, even the EC of soil was 6.95, but the EC of irrigation water was very low (0.78). Also, both ranged in the moderate phase were found.

Cotton yield were affected at Kafr El-Sheikh and Sedi Salem less than Kafr Saad, Damanhour, Edko and Alexandria due to the high EC for soils. At Kafr Saad, even the EC of soil was 6.95, but the EC of irrigation water was very low (0.78). Also, both ranged in the moderate phase were found.

**3.2. Effect of locations:**

Mean values of earliness, cotton yield and some yield components as affected by different growing locations are presented in Table (5). Before leaving this place, some points need to be tackled. Field conditions vary from site to site, not only in soil salinity, but also in soil chemical properties such as sodicity, high pH and boron and interactions between these stresses can occur. High pH can caused reduced  $K^+$  uptake even though it might not affect  $Na^+$  uptake (Ahmed, 2002) and boron can affect sub cellular distribution of salt in leaves and hence salt tolerance of the plant (Al-Nagar *et al.*, 2015).

Table (5): Effect of different locations on earliness, cotton yield and some yield components over two years

Locations Traits	Alexandria	Damanhour	Edko	Kafr El-Sheikh	Sedi Salem	Kafr Saad	Kafr El-Batekh
% Ear	77.11 ab	73.99 bc	67.01 de	81.11 a	64.52 e	70.69 cd	74.71 bc
FFN	6.00 c	7.15 a	5.63 d	6.98 ab	7.21 a	6.67 b	5.38 d
SCY K/F	10.33 bc	9.42 c	10.48 b	8.40 d	7.60 d	12.32 a	5.95 e
LCY K/F	12.27 b	11.45 b	12.22 b	10.22 c	9.10 d	14.23 a	7.18 e
BW	2.98 b	2.92 b	3.00 ab	2.66 c	2.66 c	3.09 a	2.38 d
LP	37.43 bc	38.45 a	36.79 cd	38.47 a	37.60 b	36.49 d	38.13 ab
SI	10.57 c	9.98 d	10.90 b	9.51 e	9.42 e	11.30 a	9.29 e
L. index	6.39 ab	6.28 b	6.42 ab	5.99 c	5.75 d	6.57 a	5.78 d

Means within the same row with the same letter are not significantly different at 5% level of probability.

From the data presented in Table (5), it could be said that Kafr Saad recorded the desirable traits, i.e. seed cotton yield/fad., lint cotton yield/fad., boll weight, seed index and lint index. The inhibitory

## Proceeding Book of ISESER 2023

effect of increasing salt in the field soils on agronomical and cotton yield traits of observed in the present study was previously reported by several investigators. Salinity stress at different phenological stages inhibits photosynthetic activities of the plant because it had a direct inhibitory effect on the Calvin cycle enzymes (Ottander and Oquist, 1991).

Earliness characters, the cotton genotypes grown at Kafr El-Sheikh and Alexandria were earlier than the other locations (81.11 and 77.11%), respectively. Also, the cotton genotypes grown at Edko and Kafr El-Batekh were better for position of the first fruiting node which had the lowest values (5.63 and 5.38), respectively than the other locations. The increase in salt medium delaying formations of first fruiting node on plants due to the decrease in vegetative growth of cotton plants grown in soil salinity.

Seed cotton yield and its components, the locations Kafr Saad, Edko and Alexandria recorded the highest values for seed cotton yield and lint cotton yield, because the growing location Kafr Saad recorded the highest values (12.32 and 14.23 kantar/fad.), followed by Alexandria and Edko locations, while Kafr El-Batekh recorded the lowest cotton yield 5.95 and 7.18 kantar/fad., respectively (Table 5). Regarding boll weight, it was the highest for the cotton plants which grown at Kafr Saad and Edko (3.09 g and 3.00 g), respectively, followed by Alexandria location, while at Kafr El-Batekh location, it recorded the lowest boll weight (2.38 g). With respect to lint percentage, it can be seen that the highest values were produced at Kafr El-Sheikh and Damanhour (38.47 and 38.45%), respectively, while the lowest values were produced at Kafr Saad location (36.49%). Regarding seed index, the highest value was produced at Kafr Saad (11.30 g), followed by Edko location (10.90 g), while the lowest value was (9.98 g) at Damanhour location. The highest lint index was produced at Kafr Saad (6.57 g) and not-significant difference with Edko and Alexandria locations (6.42 and 6.39 g), respectively.

A possible explanation is that the formation of bolls and their increase in weight is much more rapid under saline conditions than under non saline ones). The results also indicated that boll weight was more affected by soil salinity, and produced smaller boll. The decrease in boll weight may be due to the decrease of seed index through less of vegetative growth. This reduction in seed cotton yield/plant is mainly due to the reduction in boll weight and number of bolls/plant (N.B./P) as salt concentration increased. It is also cleared from the results that growth and fruiting of cotton plant adversely affected by salinity such effects is mainly due to the effect of salinity on certain physiological function i.e. photosynthesis and transpiration. Pandey and Sinha (1972) observed a decrease in both photosynthesis and transpiration when salinity was increased. In the same time, the results showed that seed index was highly and significantly affected by salinity levels. This reduction in seed index may be due to the decrease in number of good seeds, developed boll and the increase in number of aborted embryos. As for lint percentage (LP%), the results indicated that it was decreased as soil salinity level increased. This reduction in lint percentage may be due to the decrease in seed index. The reduction for obvious traits is sufficient reason for a reduction in yields.

These variations between different locations may be attributed to the effect of soil salinity and water quality criteria (Tables 2 and 4).

These results are in harmony with those obtained by Allam *et al.* (2008), Shaker (2009), Abd El-Bary (2013), Shaker *et al.* (2014), Shaker (2014), Abd El-Samee (2015), Abdbel-Aziz, Eman (2015), El-Ganayny, (2017), El-Seidy *et al.* (2017) and El-Fesheikwy *et al.* (2019) .

They reported that the effect of locations were significant for most previous studied characters.

## 4. CONCLUSION

The environmental conditions differed from location to another so, the gene expression differs accordingly to this condition. Kafr Saad location recorded the desirable traits *i.e* seed cotton yield (kf), Lint cotton yield (kf), boll weight (g), seed index (g) and lint index (g).

## REFERENCES

- Abdel-Aziz, Eman S. (2015). Biometrical evaluation of some promising Egyptian cotton genotypes under different environmental conditions. M.Sc. Thesis, Fac. Agric., Cairo Univ., Egypt.
- Abd El-Bary, A.M.R. (2013). Evaluation of some Egyptian cotton genotypes under different environments. J. Plant Prod. Mansoura Univ., 4(6): 957-972.
- Abd El-Samee, A.A. (2015). Genotypic stability and evaluation of some Egyptian cotton genotypes and fiber properties. M.Sc. Faculty of Agriculture, Al-Azhar University, Assiut, Egypt.

**Proceeding Book of ISESER 2023**

- Abrol IP, Yadav JSP, Massoud, FI (1988). Salt-affected soils and their management. FAO Soils Bulletin, Vol. 39 Italy, Rome, 93pp. <http://www.fao.org/decrep/x5871e/x5871e00.htm>.
- Ahmad, M. (2002). Effects of salinity on pH and ion uptake in SARC-1 wheat under hydroponic conditions. In: Ahmad RKA Malik eds. Prospects for saline agriculture. Dordrecht: Kluwer Academic Publishers, pp: 161-166.
- Allam, M.A.M., A. Abd El-Gelil, Y.A.M., Soliman and M.A. Abou El-Yazied (2008). Stability analysis of earliness, yield and fiber traits for some extra-long staple genotypes of cotton (*Gossypium barbadense* L.). Egypt. J. Agric. Res., 86 (3): 1039-1067.
- Al-Naggar, A.M.M.; S.R.S. Sabry; M.M.M. Atta and Ola M. Abd El-Alem (2015). Effect of salt stress in the field on performance, correlations, heritability and selection gain of wheat doubled haploids. International Journal of Plant & Soil Science, 8(1): 1-14.
- Bartlett, M.S. (1937). Properties of sufficiency and statistical tests. Proceedings of Royal Statistical Society, Series A. 160, 268-282.
- Brady, N.C. and R.R. Weil (2002). The Nature and Properties of Soils (13<sup>th</sup> ed.) Prentice Hall, Upper Saddle River, NJ, USA.
- Cottenie, A.; M. Verloo; G. Velghe and L. Kiekens (1982). Biological and analytical aspects of soil pollution. Lab. of Analytical Agro. State Univ. Gent, Belgium.
- Doneen, L.D. (1954). Salination of soil by salts in the irrigation water. Trans. Am. Geophys. Union 35(60): 943-950.
- Eaton, F.M. (1950). Significance of carbonates in irrigation water. Soil Sci., 69: 123-133.
- El-Fesheikwy, A.B.A. ; S.A. Shaker and A. E. I. Darwesh (2019). Behavior of some promising lines from egyptian cotton under different environmental conditions. Egypt. J. Plant Breed. 23(6):1021–1040.
- El-Ganayny, H.A.E (2017). Evaluation of some Egyptian cotton genotypes in different locations different in type of soils and quality of irrigation water. Ph. D. Thesis, Fac. Of Agric., Tanta Univ., Egypt.
- El-Seidy, E.H.; S.A. Shaker and Hanan A.E. El-Ganayny (2017). Evaluation of some Egyptian cotton cultivars for yield constancy and adaptability. J. Plant Production, Mansoura Univ., 8(2): 205-210.
- Esawy, M.; T. El-Beshbeshy; N. Abd El-Kader; R. El-Shal and N. Khalafallah (2019). Impact of biochar application on soil fertility, plant nutrients uptake and maize (*Zea mays* L.) Arab. J. Geosci. 12: 719.
- Gazia, E.A.E. (2001). The best fit relationship between sodium adsorption ratio and exchangeable sodium percentage of North Delta soils. Minufiya J. Agric. Res., 25(4): 1109-1115.
- Ghulam, A.; M. Saqib; Q. Rafique; R. M. Atiq ur Rahman; J. Akhtar; M. Anwar ul Haq and M. Nasim (2013). Effect of salinity on grain yield and grain quality of wheat (*Triticum aestivum* L.) Pak. J. Agric. Sci., Vol. 50 (1): 185-189.
- Jingang, Li.; j. Chen; j. Jin; S. Wang; and B. Du (2019). Effects of irrigation water salinity on maize (*Zea mays* L.) emergence, growth, yield, quality and soil salt. Water, 11, 2095.
- Munns, R. and R. A. James. (2019). Screening methods for salinity tolerance: a case study with tetraploid wheat. Plant Soils. 253: 201- 218.
- Ottander, C. and G. Oquist (1991). Recovery of photosynthesis in winter stressed Scot Pine. In Current Research in Photosynthesis. Plant Cell and Environ. 1(14): 345-349.
- Page, A.L. (1982). Methods of soil analysis, Part 2: Chemical and microbiological properties, (2<sup>nd</sup> ed). American Society at Agronomy Inc. Soil Sci. Soc. of Am. Inc., Madison, Wisconsin, USA.
- Pandey, S.N. and B.K. Sinha (1972). Plant Physiology. Vikas Publishing House Pvt. Limited 2<sup>nd</sup> Revised Edition.
- Richards, L.A. (1969). Diagnosis and improvement of saline and alkali soils. Agriculture Handbook No. 60 United States Department of Agriculture. Printing Office, Washington DC.
- Richmond, T.r. and S.R.H. Radwan (1962). A comparative study of seven methods of measuring earliness of crop maturity in cotton crop sci. 2: 397-400.
- Sairame, R. K.; K. V. Rao and G. C. Srivastava (2002). Differential response of wheat genotypes to long term salinity stress in relation to oxidative stress, antioxidant activity and osmolyte concentration. Plant Sci. 163: 1037- 1046.
- Saqib, M.; C. Zorb and S. Schubert (2008). Silicon-mediated improvement in the salt-resistant of wheat (*Triticum aestivum*) results from increased sodium exclusion and resistant to oxidative stress. Fun. Plant Biol. 35: 633-639.

**Proceeding Book of ISESER 2023**

- Saqib, M.; J. Akhtar and R. H. Qureshi (2004). Pot study on wheat growth in saline and waterlogged compacted soil: 1. Grain yield and yield components. *Soil till. Res.* 77: 169-177.
- Shaker, S.A. (2009). Genotypic stability and evaluation of some Egyptian cotton genotypes. Ph. D. Thesis, Fac. of Agric. Kafrelsheikh Univ., Egypt.
- Shaker, S.A. (2014). Comparative evaluation of two Egyptian extra long staple promising lines with cultivated commercial cotton varieties grown at Delta. *J. Agric. Res., Kafrelsheikh Univ.* 40(1): 27-44.
- Shaker, S.A.; M.E. Abd El-Salam and A.I.I. Darwesh (2014). Study of some earliness measurements for nine Egyptian and foreign cotton genotypes (*Gossypium barbadense*, L.). *J. Agric. Res. Kafrelsheikh Univ.*, 40(4): 929-947.
- Snedecor, G.W. and W.G. Cochran (1982). *Statistical methods*. The IOWA State Univ. Press. Ames. IOWA, USA.
- Song, Y. X.; An. J. Q; He, A. R. and Chen L. J. (2016). Effect of mulched drip irrigation with saline water on cotton growth and yield *Res. Soil water conserv.* 23: 128-132( in Chinese).
- Strogonov, B.P. (1964). *Physiological basis of salt tolerance of plants (as affected by various types of salinity)*. Olbbourne Press 1-5 Portpool Lane, London, E.C.I.

**Proceeding Book of ISESER 2023**

**O 40. EFFECT OF FERTILIZER LEVELS AND SOWING METHODS ON EARLINESS AND GRAIN YIELD OF SOME BREAD WHEAT**

El-Seidy E. H.<sup>1</sup>, U. A. Abd El-Razek<sup>1</sup>, A.A. Morad<sup>2</sup>, M.A Habow<sup>3</sup>, T. M. Abd Allah<sup>4</sup>

<sup>1</sup>*Department of Agronomy, Fac. of Agric., Tanta University.*

<sup>2</sup>*Wheat Research Depart., Field Crops Research Inst., ARC.*

<sup>3</sup>*Department of Agronomy, Fac. of Agric., Aswan University*

<sup>4</sup>*Public Administration for Seed Production. EL- Gharbia.*

E-mail: *drsayed176@gmail.com*

**ABSTRACT:** This study, conducted over the 2016/17 and 2017/18 growing seasons at the Kuotor Farm in El-Gharbia Governorate, aimed to investigate the impact of different sowing methods (Broadcasting on beds method, Drilling on beds method, and Hills on beds method) and seeding rates (45 kg, 52.5 kg, and 60 kg seeds per faddan) on the growth and yield of three bread wheat cultivars (*Triticum aestivum* L.). The results indicated that the hills sowing method outperformed drilling and broadcasting methods, leading to a gradual increase in grain yield per faddan. Specifically, the Giza 171 variety exhibited the highest values for key parameters such as the number of spikes per square meter, number of grains per spike, 1000-grain weight, biological yield, grain yield, and straw yield compared to other varieties in both seasons. Planting using the hills on bed method significantly increased the number of spikes per square meter, number of grains per spike, 1000-grain weight per spike, biological yield, grain yield, and straw yield compared to other sowing methods in both seasons. Furthermore, a seed rate of 45 kg per faddan resulted in the highest values for the number of grains per spike, 1000-grain weight, and grain yield in both seasons. Interactions between wheat varieties, planting methods, and seeding rates affected the number of spikes per square meter, biological yield, grain yield, and straw yield in both seasons, except for the harvest index in the first season. This study provides valuable insights into optimizing sowing methods and seeding rates to enhance the early growth and grain yield of bread wheat.

*Keywords: Wheat Cultivars, Sowing Methods, Grain Yield, Bread Wheat Varieties*

**O 41. SOWING METHODS INFLUENCE ON GRAIN YIELD AND ITS COMPONENTS OF SOME WHEAT CULTIVARS UNDER DIFFERENT FERTILIZER LEVES**

El-Seidy E. H.<sup>1</sup>, U. A. Abd El-Razek<sup>1</sup>, A.A. Morad<sup>2</sup>, M.A Habow<sup>3</sup>, T. M. Abd Allah<sup>4</sup>

<sup>1</sup>*Department of Agronomy, Fac. of Agric., Tanta University.*

<sup>2</sup>*Wheat Research Depart., Field Crops Research Inst., ARC.*

<sup>3</sup>*Department of Agronomy, Fac. of Agric., Aswan University*

<sup>4</sup>*Public Administration for Seed Production. EL- Gharbia.*

E-mail: *drsayed176@gmail.com*

**ABSTRACT:** Two field experiments were conducted at the Farm of Kuotor - EL- Gharbia Governorate during 2016/17 and 2017/18 growing seasons to study the effect of three sowing methods [Broadcasting on beds method, Drilling on beds method and Hills on beds method] and three seeding rates (45, 52,5 and 60 kg seeds/fad.) on growth and yield of three bread wheat cultivars (*Triticum aestivum* L.). Regarding hills sowing method was better for growing wheat plants and gradually increased grain yield/fad than drilling and broadcasting methods. Giza 171 variety gave the highest values No. of spikes/m<sup>2</sup>, No. of grains/spike, 1000-grain weight, biological yield, grain yield and straw yield compared with the other varieties in the first and second seasons. planting by hills on bed method increased significantly No. of spikes/m<sup>2</sup>, No. of grains/spike, 1000- grain weight/spike, biological yield, grain yield and straw yield compared with the other sowing methods in the first and second seasons. The highest values of no. of grains/spike, 1000-grain weight and grain yield were found with seed rate (45 kg/fad.), in both seasons. No. of spikes/m<sup>2</sup>, biological yield, grain yield and straw yield were affected by the interaction between wheat varieties and planting methods with seeding rates in the first and second seasons except harvest index in the first season.

*Keywords: Wheat Cultivars, Sowing Methods, Grain Yield and Its Components And Seeding Rates*

## **1. INTRODUCTION**

Wheat is considered the most important productive cereal crop in the World (Coventry *et al.*, 2011). Therefore, it has a strategic position with competition for many other crops produced in the world. This importance comes from its use principally in human food in many world countries especially Egypt, where it is used in bread production and also several food industries.

Wheat (*Triticum aestivum*, L.) has been considered the first strategic food crop for more than 7000 years in Egypt. It has maintained its position during that time as the basic staple food in urban areas and mixed with maize in rural areas for bread making. In addition, wheat straw is an important fodder (Gomaa, 1999).

Raising wheat production through increasing productivity and increasing the cultivated area is an important national target to minimize the gap between the Egyptian production and consumption. The total production of wheat reached at least 9 million tons annually (FAO, 2016); while, the annual consumption of wheat grains in Egypt is about 15 million tons. Increasing wheat yield per unit area can be achieved by breeding high yielding varieties or improving the cultural treatments of the crop. New wheat varieties were developed to maximize grain yield under favorable environmental conditions (high input conditions especially planting methods to save water supply and seeding rate).

Egypt imports above 5.5 million tons of wheat grains. Unless domestic wheat production increases, the deficit will increase due to the increased birth rate (about 2%) and present the high per-capita consumption which is estimated by 180 kg /year\*. More than 3 million faddans are cultivated annually with wheat. The average productivity is about 2.7 ton/fad; where the recent high yielding wheat varieties have been cultivated.



## Proceeding Book of ISESER 2023

Several investigators showed that wheat cultivars differed in yield and its components as well as chemical properties (Hassan, 2008, Ashmawy *et al*, 2010, Mehasen *et al*, 2015). Also (Zenhom *et al*, 2018) reported that wheat cultivars were varied significantly in plant height, No. spikes/m, seed index and grain yield/fed.

Optimum seeding rate may be of treatments main to increase wheat yield by improving yield components of wheat plants and applying the scientific recommendations in that respect.

## 2. MATERIALS AND METHODS

Two field experiments were carried out in the Middle of Nile Delta (the Private Farm of Kuotor - EL-Gharbia Governorate) during the two successive seasons of 2016/17 and 2017/18 to study the effect of three sowing methods and three seeding rates on growth, yield and yield components of three bread wheat cultivars (*Triticum aestivum* L.).

The experimental design was a split-split-plot design with three replications in both seasons. The main plot treatments were occupied by the three wheat cultivars, while the three sowing methods were assigned in the sub-plots and the three seeding rates in the sub-subplots. Sowing dates were 15th November in the first season and 20th November in the second one. The harvest area was 7.2 m<sup>2</sup>, (2.4 width and 3m in length).

### Soil chemical analysis

The soil of the experimental site of Kuotor is clay in texture and fairly uniform without distinct changes in texture. Soil samples were taken before sowing during the two seasons at soil depth of 0-30 cm and 30-60 cm. Some soil physical and chemical characteristics of the experimental site were determined and presented in Table (1).

The following data was recorded during the growing seasons at and after harvest as follows:

#### A. Growth characteristics:

A.1. Date of expulsion: Number of days from sowing to the date when 50% of spikes complete emergence from flag leaf of the plot.

A.2. Flag leaf area, FLA (cm)<sup>2</sup>: Mean areas of flag leaves of ten random leaves within each plot were separated and their green area were measured using a LI-3100 (LI-COR, Lincoln, Nebraska, USA) leaf area meter, according to Watson *et al.*(1963).

FLA= (leaf length x maximum width of flag leaf x 0.75) at 125 days.

A.3. Date of maturity: Number of days from sowing to date when 50% of spikes and top of the peduncles turned yellow of the plot.

A.4. Plant height (cm.): Plant length from the soil surface to the tip of the spikes, excluding awns.

#### B-Yield and its components:

At harvest, ten wheat plants were chosen at random from each plot to study the following characters:

B.1. Spike length (cm.): Ten main spikes were chosen; their average was calculated to express spike length in cm.

B.2. Number of spikes/m<sup>2</sup>: Number of fertile tillers/m<sup>2</sup> was calculated by counting all spikes per square meter.

B.3. Number of kernels/spike: It was counted as an average number of grains collected per spike.

B.4. 1000-grain weight (g): A random sample of 1000-grains was taken from each plot, hand counted and weighted.

B.5. Grain weight /spike (g): Average number of grains of ten randomly chosen spikes and weighted.

B.6. Grain yield (ardab/fad): Recorded for the harvested area after threshing and then converted to ardab/fad (One ardab = 150 kg on the basic of 14.5% moisture content and one faddan = 4200 m<sup>2</sup>).

B.7. Straw yield (ton/fad.): Determined as the difference between biological and grain yield of sub plot in terms of kg/plot and converted to ton/fad.

### **Proceeding Book of ISESER 2023**

B.8. Biological yield (ton/fad.): It was recorded for the harvested area and converted to ton/fad.

B.9. Harvest index (HI): It was recorded as a ratio of grain yield to the total biological yield.

$$HI = (\text{Grain yield} / \text{Biological yield}) \times 100$$

### **Statistical analysis**

Data were subjected to the proper statistical analysis as the technique of analysis of variance (ANOVA) of split-split plot design as mentioned by Gomez and Gomez (1984). Treatment means were compared using the Least Significant Difference (LSD) test as outlined by Waller and Duncan (1969).

### **3. RESULTS AND DISCUSSION**

A- wheat cultivars:

Results in Tables (2) and (3) showed that Giza 171 gave the highest on heading date, flag leaf area, FLA (cm)<sup>2</sup>, date of maturity, plant height (cm.), spike length (cm.) and grain yield, while, the wheat cultivar Shandaweel 1 recorded the lowest values in both seasons. This result due to it's a genetic character specific to the cultivar and the differences may be due to variability among the wheat cultivars under study which considered adequate for further biometrical assessment. These results are in harmony with those obtained by El- Samahy (2009), Rahman et al., (2010), El- Hag (2012), El- Hag (2015), El-Seidy et al., (2016) and Wogene and Anjulo (2017).

B- Sowing methods:

Sowing methods had significantly effect on heading date, flag leaf area, FLA (cm)<sup>2</sup>, date of maturity, plant height (cm.), spike length (cm.) and grain yield in both seasons, as shown as in Tables (2) and (3).

The hills on bed sowing method recorded the highest flag leaf area, plant height (cm.), spike length (cm.) and grain yield, while, the broadcasting on bed method recorded the highest values on heading date and date of maturity in both seasons. These results are in harmony with those obtained by Wang et al., (2011), Ali et al., (2012), Genedy (2014), El-Hag (2015), Abdul Razaq et al., (2016), El-Seidy et al., (2016) and Singh et al., (2017).

C- Seeding rates:

Regarding the effect seeding rates on heading date, flag leaf area, FLA (cm)<sup>2</sup>, date of maturity, plant height (cm.), spike length (cm.) and grain yield was highly significant in both seasons, as shown as in Tables (2) and (3).

The highest values of heading date, date of maturity and plant height (cm.) were found with seed rates 60 kg/fad in both seasons, while, the lowest values were recorded from using 45 kg/fad in both seasons. On another hand added 45 kg seed/fad. recorded the highest flag leaf area, FLA (cm)<sup>2</sup>, spike length (cm.) and grain yield in both seasons. These results are in agreement with Avijit-Sen et al. (2003), Boyd et al., (2009), Laghari et al., (2011), Gross et al., (2012), Javaid Iqbal et al., (2012), Said et al., (2012), May et al., (2014), Naveed et al., (2014), Al-Hilfy and Wahid (2017) and Tadesse et al., (2017).

D- Interaction:

Results indicated that sowing methods and seeding rates significantly affected in all the studied characters, as shown as in Tables (2) and (3).

The interactions between cultivars and sowing methods (C x M) was highly significant concerning with flag leaf area and grain yield in both seasons as shown as in Tables (2) and (3). While the interaction between cultivars and sowing methods on heading date, date of maturity, plant height (cm.), spike length (cm.) was not significant in both seasons. These results are in full agreement with those of Soomro et al., (2009) and Kiliç (2010).

The interaction between cultivars and seeding rates (C x S) on flag leaf area, date of maturity and grain yield was highly significant in both seasons, as shown as in Tables (2) and (3). While the interaction between cultivars and seeding rates on heading date, plant height and spike length (cm.) was not significant in both seasons. as shown as in Tables (2) and (3). These results are in full agreement with those of Soomro et al., (2009) and EL Hag (2016).

**Proceeding Book of ISESER 2023**

The interaction between sowing methods and seeding rates (M x S) on flag leaf area and grain yield (ardab/fad.) was highly significant in both seasons, as shown as in Tables (2) and (3). Effect interaction between sowing methods and seeding rates on date of maturity was significant in second season only, as shown in Table (2). While the interaction between sowing methods and seeding rates on heading date, plant height (cm.), spike length (cm.) was not significant in both seasons. These results are in a good accordance with those obtained by Balkaran (2011), El-Lattief (2011) and Tadesse et al., (2017).

The interaction between cultivars, sowing methods and seeding rates (C x M x S) on flag leaf area, date of maturity and grain yield (ardab/fad.) was highly significant in both seasons, as shown as in Tables (2) and (3), while, heading date, plant height (cm.), spike length (cm.) was not significant in both seasons.

Table (1): Physical and some chemical properties of the experimental soil during 2016/17 and 2017/18 season.

Properties	2016/17	2017/18
<b><u>Mechanical analysis :</u></b>		
Sand %	22.73	21.95
Silt %	31.50	31.85
Clay %	45.80	46.17
Soil texture	Clay	Clay
<b><u>Chemical analysis :</u></b>		
pH	8.30	8.05
Ec dS / m	2.30	2.34
O.M %	1.80	1.85
Available N ( mg/kg)	31.80	30.79
Available P ( mg/kg)	7.01	6.01
Available K ( mg/kg)	119.00	121.02
Available Zn ( mg/kg)	0.21	0.27
<b><u>Cation ( meq / L ) :</u></b>		
Ca <sup>++</sup>	12.85	13.04
Mg <sup>++</sup>	10.23	11.85
Na <sup>+</sup>	42.08	41.22
K <sup>+</sup>	51.37	53.07
<b><u>Anion ( meq / L ) :</u></b>		
CO <sub>3</sub> <sup>-</sup>	0.02	0.05
HCO <sub>3</sub> <sup>-</sup>	2.87	2.93
Cl <sup>-</sup>	62.57	63.45
SO <sub>4</sub> <sup>-</sup>	49.88	51.07

**Proceeding Book of ISESER 2023**

Table (2): Effect of cultivars, sowing methods, seeding rates and their interactions on heading date (day), flag leaf area, FLA (cm)<sup>2</sup> and date of maturity (day) at harvest in 2016/17 and 2017/18 seasons.

Characters Treatments	Heading date (day)		Flag leaf area, FLA (cm) <sup>2</sup>		Date of maturity (day)	
	Season 2016/17	Season 2017/18	Season 2016/17	Season 2017/18	Season 2016/17	Season 2017/18
<b>A: Cultivars (C)</b>						
Shandaweel 1	91.78	87.44	48.83	43.54	136.15	130.11
Gemmeiza 11	94.11	90.33	50.79	45.41	139.59	132.85
Giza 171	96.33	92.56	52.98	47.62	140.07	135.00
F-test	**	**	**	**	**	**
LSD at 0.01	2.88	2.55	1.15	1.27	0.98	1.17
<b>B: Sowing methods (M)</b>						
Hills	94.00	89.33	60.81	55.53	137.56	131.70
Drilling	91.22	87.11	48.16	42.79	134.82	128.82
Broadcasting	97.00	93.89	43.62	38.26	143.44	137.44
F-test	**	**	**	**	**	**
LSD at 0.01	1.60	1.61	0.75	0.81	2.93	2.94
<b>C: Seeding rates (S)</b>						
45 Kg/fad.	91.00	86.44	53.95	48.68	135.37	129.37
52.5 Kg/fad.	94.00	90.22	51.24	45.87	138.19	132.30
60 Kg/fad.	97.22	93.67	47.40	42.03	142.26	136.30
F-test	**	**	**	**	**	**
LSD at 0.01	0.80	0.81	0.35	0.37	0.80	0.75
<b>D: Interactions effects</b>						
C x M	NS	NS	**	**	NS	NS
C x S	NS	NS	**	**	**	**
M x S	NS	NS	**	**	NS	*
C x M x S	NS	NS	**	**	**	**

\*and \*\* Significant at 0.05 and 0.01 levels of Probability, respectively, while NS means non-Significant.

**Proceeding Book of ISESER 2023**

Table (3): Effect of cultivars, sowing methods, seeding rates and their interactions on plant height (cm.), spike length (cm.) and grain yield (ardab/fad.) at harvest in 2016/17 and 2017/18 seasons.

Characters Treatments	Plant height (cm.)		Spike length (cm.)		Grain yield (ardab/fad.)	
	Season 2016/17	Season 2017/18	Season 2016/17	Season 2017/18	Season 2016/17	Season 2017/18
<b>A: Cultivars (C)</b>						
Shandaweel 1	96.11	93.63	12.74	12.46	19.70	17.13
Gemmeiza 11	100.67	99.26	13.37	13.09	21.66	18.32
Giza 171	104.74	103.15	14.52	14.17	22.41	19.15
F-test	**	**	**	**	**	**
LSD at 0.01	2.24	2.97	0.50	0.71	0.19	0.23
<b>B: Sowing methods (M)</b>						
Hills	106.70	104.15	15.13	14.82	22.41	19.76
Drilling	102.15	99.15	13.32	12.98	21.66	18.39
Broadcasting	92.67	92.74	12.19	11.93	19.70	16.44
F-test	**	**	**	**	**	**
LSD at 0.01	1.54	1.75	0.57	0.66	0.12	0.12
<b>C: Seeding rates (S)</b>						
45 Kg/fad.	96.11	94.74	14.57	14.24	21.68	18.58
52.5 Kg/fad.	100.59	98.52	13.52	13.26	21.10	18.11
60 Kg/fad.	104.82	102.78	12.54	12.22	20.99	17.90
F-test	**	**	**	**	**	**
LSD at 0.01	1.43	1.55	0.34	0.39	0.11	0.12
<b>D: Interactions effects</b>						
C x M	NS	NS	NS	NS	**	**
C x S	NS	NS	NS	NS	**	**
M x S	NS	NS	NS	NS	**	**
C x M x S	NS	NS	NS	NS	**	**

\*and \*\* Significant at 0.05 and 0.01 levels of Probability, respectively, while NS means non-Significant.

**REFERENCES**

- Abdul Razaq, M. J. K.; T. Sarwar and M. J. Khan (2016). Effect of deficit irrigation, sowing methods and mulching on wheat yield and nitrogen uptake, *Pakistan J. Agric. Res.* 29(3): 222-228.
- Al-Hilfy, H. H. Intsar and S. A. Wahid (2017) Seeding rates influence on growth and straw yield of some bread wheat cultivars and their relationship with accumulated heat units. *American-Eurasian Journal of Sustainable Agriculture.* 11(5): 49-58.
- Ali, M.; L. Ali; M. Q. Waqar and M. A. Ali (2012). Bed planting: A new crop establishment method for wheat (*Triticum aestivum*, L.) *Int. J. Agric. Appl. Sci.*, 4(1): 834-841.
- Ashmawy, F.; M. S. El-Habal; H. S. Saoudy and Iman Kh. Abbas (2010). The relative contribution of yield components to grain yield of some wheat cultivars grown under different nitrogen fertilizer levels. *Egypt. J. Agric. Res.*, 88(1):225-239.

**Proceeding Book of ISESER 2023**

- Avijit-Sen.; M. D. Pandey; S. N. Sharma; R. K. Singh; Ajay-Kumar; Prakash-Shukla and V. K. Srivastava (2003). Surface seeding of wheat (*Triticum aestivum*, L.), as affected by seed rate and nitrogen level. *Indian. J. Agric. Sci.*; 73(9): 509-511.
- Balkaran Singh; R. S. Uppal (2011). Interaction effect of sowing time, planting method and seed rate on performance of wheat variety PBW 550. *Environment and Ecology*, 29(3):1087-1090.
- Boyd, S. N; B. E. Brennan; F. R. Smith and R. Yokota (2009). Effect of seeding rate and planting arrangement on rye cover crop and weed growth. *Agronomy Journal*, 101 (1): 47-51.
- Coventry, D.R.; R.K. Gupta ; A. Yadav ; R.S. Poswal ; R.S. Chhokar and Cummins, J.A.(2011). Wheat quality and productivity as affected by varieties and sowing time in Haryana. *India F. Cr. Res.*, 123(3): 214-225.
- El- Hag, Dalia, A. A. (2012). Effect of planting date and nitrogen level on yield and quality of bread and durum wheat. Ph D. Thesis, Fac. of Agric., Kafr El-Sheikh Univ., Egypt.
- El Hag, D. A. A. (2016). Effect of seeding rates on yield and yield components of two bread wheat cultivars. *J. Agric. Res. Kafr El-Sheikh Univ.* 42(1) 71-81.
- El-Hag, Walaa, A.A. (2015). Morphological studies on bread wheat under different regimes and planting methods. Ph.D. Thesis, Fac. of Agric., Kafr El-Sheikh Univ., Egypt.
- El-Lattief, E. A. A. (2011). Bread wheat (*Triticum aestivum* L.) productivity and profitability as affected by method of sowing and seeding rate under Qena environment. *Asian Journal of Crop Science*, 3(4):188-196. 35 ref.
- El-Samahy, E. S. M. Basma (2009). Effect of nitrogen, potassium fertilizer on yield and component some wheat genotypes. M.Sc. Thesis, Fac. of Agric., Kafr El-Sheikh Univ., Egypt.
- El-Seidy E. H., A. M. Moussa, U .A. Abd El-Razek and M. O. Al-Farouk (2016). Effect of irrigation deficit and sowing methods on growth characters and water requirements of some wheat cultivars. *Wheat Research Dept., Field Crops Research Inst., ARC*.
- F. A. O (2016). Food outlook biannual report on global food markets. Food and Agriculture Organization of the United Nations.
- Genedy, M. S. A. (2014). Effect of some planting methods, nitrogen fertilization rates and irrigation on wheat grain yield. Ph D. Thesis, Fac. of Agric., Mansoura Univ., Egypt.
- Gomaa, A.S.A (1999). Wheat improvement in Egypt: History and future prospects. *Egypt. J. Plant Breeding*, 3(1): 1-14.
- Gomez, K. A and A. A. Gomez (1984). Chi-square test. Pages 458-477 in *Statistical Procedures for Agricultural Research*. John Wiley and Sons. Toronto.
- Gross, T. F.; A. R. Dias; C. Kappes; L. M. Schiebelbein; J. L. Anselmo and H. V. Holanda (2012). Productive performance of wheat in different sowing methods and densities. [Portuguese] *Scientia Agraria Paranaensis*, 11(4):50-60.
- Hassan, Manal A. (2008). Effect of seeding rate and row spacing on productivity and resistance to powdery mildew of two bread wheat cultivars. *Egypt. J. Appl. Sci.*, 23(10): 169-182.
- Javaid Iqbal; Khizer Hayat; Safdar Hussain; Anser Ali; Bakhsh, M. A. A. H. A. (2012). Effect of seeding rates and nitrogen levels on yield and yield components of wheat (*Triticum aestivum* L.). *Pakistan Journal of Nutrition*; 2012. 11(7):531-536. 33.
- Kiliç, H. (2010). The effect of planting methods on yield and yield components of irrigated spring durum wheat varieties. *Scientific Research and Essays*. 5 (20), pp. 3063-3069.
- Laghari, G. M.; Oad, F. C.; Shamasuddin Tunio; Qamaruddin Chachar; Gandahi, A. W.; Siddiqui, M. H.; Syed Waseem-ul-Hassan; Abid Ali (2011). Growth and yield attributes of wheat at different seed rates. *Sarhad Journal of Agriculture*; 2011. 27(2):177-183. 33.
- May, W. E.; M.R. Fernandez; F. Selles and G.P. Lafond (2014). Agronomic practices to reduce leaf spotting and fusarium kernel infections in durum wheat on the Canadian Prairies. *Canadian Journal of Plant Science*, 94(1):141-152.

**Proceeding Book of ISESER 2023**

- Mehasen, S.A.S.; Shima A. Badawy and S. Sh. Abdullah (2015). Influence of bio and mineral nitrogen fertilizers on productivity of some bread wheat varieties. *J. of Food, Agriculture & Environment*, 13 (2): 162-167.
- Naveed, K.; M.A. Khan; M.S. Baloch; K. Ali; M.A. Nadim; E.A. Khan; S. Shah and M. Arif (2014). Effect of different seeding rates on yield attributes of dual-purpose wheat. *Sarhad Journal of Agriculture*, 30(1):83-91.
- Rahman, M. A.; S. J. Hossain; M. B. Hossain; M. R. Amin and K. K. Sarkar (2010). Effect of variety and cultural method on the yield and yield attributes of wheat. *Int. J. Sustain. Crop Prod.* 5(3):17-21.
- Said, A.; H. Gul; B. Saeed; B. Haleema; N. L. Badshah and L. Parveen (2012). Response of wheat to different planting dates and seeding rates for yield and yield components. *Journal of Agricultural and Biological Science*; 7(2):138-140.
- Singh, C. M. K. K.; S. Bahadur; N. S. Devra; P. Kumawat and A. Kumar (2017). Effect of sowing methods, scheduling of irrigation based on IW/CPE ratio and chemical weed control on plant height, dry matter accumulation and yield of wheat, *Journal of Pharmacognosy and Phytochemistry*; 6(3): 169-172.
- Soomro, U. A.; M. Ur Rahman; E. A. Odhano; S. Gul and A. Tareen (2009). Effects of sowing method and seed rate on growth and yield of wheat (*Triticum aestivum* L.). *World J. Agric. Sci.* 5 (2):159-162.
- Tadesse, A.; T. Yoseph and M. Mitiku (2017). Effect of sowing methods and seed rate on yield of bread wheat (*Triticum aestivum*, L.) at South Ari District, South Omo Zone, Snnpr, Ethiopia. *International J. of Research-Granthaalayah*, 5(6):175-180.
- Waller, R.A. and D.B. Duncan (1969). A bays rule for the symmetric multiple comparison problem. *Am. Stat. Assoc. J.*, 1485-1504.
- Wang, F.; L. Kong; K. Sayre; S. Li; J. Si; B. Feng and B. Zhang (2011). Morphological and yield responses of winter wheat (*Triticum aestivum*, L.) to raised bed planting in Northern China. *African J. of Agri. Res.*, 6(13): 2991-2997.
- Watson, D.J.; G.N. Thorne and S.A.W. French (1963). Analysis of growth and yield of winter and spring wheats. *Ann. Bot. N. S.* 27(1):1-22.
- Wogene, S. and A. Anjulo (2017) Response of bread wheat varieties to different levels of nitrogen at Doyogena, Southern Ethiopia. *International Journal of Scientific and Research Publications*, 7(2): 452-459.
- Zenhom, M. F. T; G. Y. Hammam and S. A. S. Mehasen (2018). Wheat lodging and yield in response to cultivars and foliar application of paclobutrazol. 4th International Conference on Biotechnology Applications in Agriculture (icbaa), 4-7 Hurgada, Egypt Invited Papers, 639-644.

**O 42. THE ROLE OF SOME ANTIOXIDANTS FOLIAR APPLICATION ON BIO-CHEMICAL AND YIELD OF TWO WHEAT CULTIVARS GROWN UNDER SALINITY STRESS**

EL-Seidy, E.H. El-Sayed<sup>1</sup>, Eman, N.M. Mohamed<sup>2</sup> and Shrouk, H. Khalifa<sup>1\*</sup>

<sup>1</sup>*Agronomy Dep., Faculty of Agriculture, Tanta University, Egypt*

<sup>2</sup>*Seed Technology Research Department, Field Crops Research Institute, Agricultural Research Center, Egypt*

E-mail: *drsayed176@gmail.com, Emannabel923@gmail.com, shroukhassan1998@gmail.com*

**ABSTRACT:** Salinity stress is one of adversely affect cereal crop yield and quality all over the world. Improving salt tolerance in wheat plants by breeding new cultivars and a foliar application of antioxidants as alleviating treatments to enhance plant production under salinity stress. The aim of this work was to study the role of some antioxidants foliar application on bio-chemical of two wheat (*Triticum aestivum* L.) cultivars grown under salinity stress. In a split-split plot design with three replicates. Factors were 2 soil types (normal and saline), 2 wheat cultivars (Sakha 95 and Misr 3), and 4 foliar spray treatments (control, 300 mg silicate potassium L-1, 200 mg ascorbic acid L-1 and 200 mg salicylic acid L-1). The effect was highly positive on the biochemical characteristics of wheat when a combination of foliar spray with 200 mg ascorbic acid L-1 with Sakha 95 under saline soil caused considerable increases in the chlorophyll content, peroxidase activity, catalase activity, grain yield and chemical analysis of grain (carbohydrates, P and K%). While the highest content of proline and protein were obtained with c.v Misr 3 + foliar spray by 200 mg ASA L-1. It can be concluded that using cv Sakha 95 and a foliar spray by the ASA is most effective ways for increasing wheat productivity under salinity stress condition.

*Keywords: Cultivars Grown Under Salinity Stress*

## **1. INTRODUCTION**

Comprising 13.1% of world soils are salt-affected soils (FAO, 2021 b). Nearly 56% of irrigated soils are salt-affected at the Northan Egyptian Nile Delta (Aboelsoud *et al.*, 2022). Salt stress collectively inhibits cell division and expansion, as well as modulate the activity of some key enzymes, thus lastly reducing the seed reserves utilization (El-Hendawy *et al.*, 2019). Also, it has pronounced damaging effects on the physiological, morphological, and biochemical characteristics of the crop plants, including uptake of water and nutrients, germination, growth, photosynthesis, enzyme actions, and yield (Cisse *et al.*, 2019 and Arif *et al.*, 2020).

Wheat (*Triticum aestivum*) is considered one of the world's major cereals, especially in Egypt (FAO, 2020). The national production represents about 8.9 million Mg (2020-2021), and the total consumption increased to 20.6 million Mg due to the annual population growth, which is considered a high country in wheat imports (FAO, 2021 a).

The management of salt-affected soils, improving salt-tolerant crops, this triggered plant breeders to initiate breeding programs aimed at developing salt-tolerant crop cultivars (Ashraf and Munns 2022). Khedr *et al.*, (2023) noted that Sakha 95 and Misr 3 cultivars had no significant differences in chlorophyll content, proline, POD, CAT activity, wheat yield, and its attributes under salt stress.

The integrated and sustainable strategy to enhance salt tolerance in wheat by using the spray foliar application of antioxidants and growth regulators to mitigate the harmful effect of salinity on wheat yield and grain quality (El-Sabagh *et al.*, 2021). Under salt stress conditions, the foliar application of potassium silicate increases the enzymatic activities of antioxidants, thereby reducing the permeability of the plasma membrane and increasing the activity of the roots. This, in turn, enhances nutrient uptake (Ibrahim *et al.*, 2016), and improves plant growth (Ahmad *et al.*, 2013). Also Feghhenabi *et al.*, (2022) noted that the foliar spray by K<sub>2</sub>SiO<sub>3</sub> increased catalase and peroxidase activities in wheat grown under saline conditions, which



**Proceeding Book of ISESER 2023**

alleviated the oxidative damage of proteins and lipids. As same as the salicylic acid exogenously applied can maintain cellular detoxification through the regulation of antioxidant defense systems (El-Hawary *et al.*, 2023), regulation of plant physiological processes (Talaat and Shawky 2022). Furthermore, the application of SA enhanced antioxidant defensive or/and tolerance mechanisms which increased growth, pigment concentration, nutrient uptake and yield of wheat under salinity Stress (Noreen *et al.*, 2019). Iqbal *et al.*, (2022) showed that the exogenous application of 1.0 mM of salicylic acid (SA) positively influenced the 90% germination percentage, growth, biomass of plants, gas exchange attributes, photosynthetic rate, glycine betaine, MDA, carbohydrates, protein, and electrolyte leakage, antioxidant activities of enzymes and yield parameters of wheat under salinity stress. Also, ascorbic acid is one of the most important antioxidants in plants that alleviate different environmental stresses, furthermore, it has been found to enhance markedly the capacity of antioxidants and to improve protein metabolism to moderate oxidative stress (Akram *et al.*, 2017), which plays an important role in enhanced salt tolerance of wheat plant and improved shoot length, root weight, grain weight, and biochemical compounds e.g. chlorophyll, starch, fiber, ash, and fat (El-Kassas *et al.*, 2020). The foliar application of ascorbic acid increased the yield of the wheat crop (Osman and Nour Eldein 2017 and Ishaq *et al.*, 2021). The main objective of the present study is to use foliar antioxidant spray to alleviate hazards on biochemical characteristics and yield of wheat (*Triticum aestivum* L.) grown under stress condition.

**2. MATERIALS AND METHODS**

**2.1. Experimental design and Treatments**

In a split split-plot design with three replicates, a lysimeters experiment was carried out on two wheat cultivars (*Triticum aestivum* L., c.v Sakha 95 and Misr 3) during two successive seasons 2020/21 and 2021/22 at Sakha Agricultural Research Station, Kafr El-Sheikh Governorate, Egypt (31° 5'38.70" latitude N and 30°56'54.00" longitude E with an elevation 6 m above mean sea level). This study aimed to study the effect of foliar spraying with antioxidants on the productivity of wheat crop (*Triticum aestivum* L.) and reduce the harmful effect of salinity on biochemical characteristics and productivity of two cultivars of wheat (Sakha 95 and Misr 3) under salt stress condition. The main plots included 2 soil types (normal and saline), the sub-plots were randomly assigned to 2 wheat cultivars (Sakha 95 and Misr 3), and the sub-sub plots were to 4 foliar treatments: control, 300 mg silicate potassium L<sup>-1</sup>, 200 mg ascorbic acid L<sup>-1</sup> and 200 mg salicylic acid L<sup>-1</sup>). Some soil properties as shown in Table 1.

The total lysimeters used were 48 plots (lysimeter area was 0.78 m<sup>2</sup>), which had divided into 4 groups; each group includes 12 lysimeters. Two wheat cultivars (Sakha 95 and Misr 3) were graciously supplied by the Sakha Wheat Research Department, Field Crops Research Institute, Agricultural Research Center, Egypt; Names, pedigrees and Selection history are shown in Table 2.

Plants were irrigated every 30 days and all cultural practices were followed according to the recommendations of the Egyptian Ministry of Agriculture. All foliar application treatments were applied twice at 35 and 50 days after sowing.

**Table 1.** Soil test of the lysimeter experiment before two growing seasons.

Soil types	Lysimeters	pH	EC (dS m <sup>-1</sup> )	ESP	OM (%)	BD (Mg m <sup>-3</sup> )	Soil mechanical analysis (%)		
							Sand	Silt	Clay
Normal	Group 1	8	3.5	9.33	1.3	1.32	19.1	29.8	51.2
	Group 2	8	3.3	8.93	1.2	1.31	19.2	29.9	50.9
	Group 3	7.9	3.4	9.16	1.2	1.33	19.1	29.9	51.1
	Group 4	8.1	3.7	10.2	1.2	1.31	19.2	30	50.9
	<b>Average</b>	<b>8</b>	<b>3.5</b>	<b>9.41</b>	<b>1.2</b>	<b>1.32</b>	<b>19.1</b>	<b>29.9</b>	<b>51.0</b>
Saline	Group 1	8.3	8	15.4	1.2	1.36	18.6	29.1	52.2
	Group 2	8.3	8.2	15.6	1.2	1.34	18.9	29.5	51.6
	Group 3	8.3	8.1	15.9	1.2	1.33	18.8	29.4	51.8

**Proceeding Book of ISESER 2023**

Group 4	8.3	7.9	15.4	1.2	1.36	18.7	29.2	52.1
<b>Average</b>	<b>8.3</b>	<b>8.1</b>	<b>15.6</b>	<b>1.2</b>	<b>1.35</b>	<b>18.8</b>	<b>29.3</b>	<b>51.9</b>

\* pH = Power Of Hydrogen, EC = Electrical Conductivity, ESP= Exchangeable Sodium Percentage, OM%= Organic matter content, BD= Bulk density

**Table 2.** Pedigrees and Selection history of the studied wheat cultivars

<b>Cultivar</b>	<b>Pedigree&amp;Selection history</b>
Sakha 95	PASTOR//SITE/MO/3/CHEN/AEGILOPS SQUARROSA(TAUS)//BCN/4/WBLL1(CMSA01Y00158S-040P0Y-040M-030ZTM- 040SY-26M-0Y-0SY-0S).
Misr 3	ATTILA*2/PBW65*2/KACHU (CMSS06Y00582T-099TOPM-099Y-099ZTM-099Y-099M-10WGY-0B-0EGY).

## 2.2. Measurements and analysis

### 2.2.1. Soil analysis

Soil samples representing the surface of 30 cm were collected for analysis according to methods cited by Richards (1954), Vomocil (1957), Dewis and Fertias (1970), Hesse (1971), Cottenie *et al.*, (1982) and Page *et al.*, (1982).

### 2.2.2. Studied characteristics:

At the heading stage, 10 flag leaves were randomly selected from each plot to estimate the following characteristics:

#### 2.2.2.1. Biochemical characteristics

Chlorophyll content ( $\mu\text{g ml}^{-1}$ ):

Chlorophyll a and b were determined according to Moran (1982). The leaves were homogenized in N-N-dimethyl formamid and determined using the spectrophotometric technique

#### 2.2.2.2. The content of some enzymes in the leaves

- Proline content of leaves ( $\text{mg g}^{-1}\text{FW}$ ):

Proline content was determined according to the method of Bates *et al.*, (1973) was perused UV-VIS Spectrophotometer at 520 nm.

- Catalase activity ( $\text{CAT } \mu\text{mol min}^{-1} \text{g protein}^{-1}$ ) according to Lum *et al.*, (2014) on a UV-Vis spectrophotometer, the optical density was measured at 240 nm at 0 and 3 minutes.

- Peroxidase activity ( $\text{POD } \mu\text{mol min}^{-1} \text{g protein}^{-1}$ ) according to (Jebara *et al.*, 2005 and Lum *et al.*, 2014). Absorbance was read at 436 nm on a UV-Vis spectrophotometer at 0 and 3 minutes.

#### 2.2.3. Grain yield and its chemical analysis:

Grain yield was calculated by harvesting whole plants in each plot and air dried, then threshed and the grains at 13 % moisture were weighted in kg and converted to  $\text{ton fed}^{-1}$ . Grain samples were taken at random from each plot and grounded into a fine powder to pass through 2mm mesh for chemical analysis, i.e. crude carbohydrate content and crude protein ( $\text{N}\% \times 5.75$ ) was determined according to the procedures of the A.O.A.C. (1990) and expressed as a percentage of the dry weight of the sample. Both Na and K were estimated by a flame Photometer according to Jackson, 1967, and P was determined by using hydroquinine method and measured by a spectrophotometer at a 660 nm wavelength (Snell and Snell, 1967).

## 2.3. Statistical analysis

All statistical analysis was performed using analysis of variance technique by “MSTAT-C” (1990) computer software package and treatment means was compared with Duncan Multiple Range Test the treatments were compared at 0.01% level of significance Duncan (1955).

## 3. RESULTS

### 3.1. Biochemical characteristics

#### 3.1.1. Chlorophyll content

Chlorophyll a, and b content in the flag leaf of wheat cultivar Sakha 95 and Misr 3 as affected by soil

**Proceeding Book of ISESER 2023**

salinity and foliar spray, and their interaction in the 2020/21 and 2021/22 seasons are presented in Table (3). Data refer that the soil salinity resulted in a highly negative effect on chlorophyll content in both seasons. Soil salinity caused a marked reduction in chl. a (13.33 and 7.69 %), and chl. b (29.83 and 25.00%) compared with normal soil in the two seasons, respectively.

The achieved results shows in Table (3) indicated that, Sakha 95 cultivar exceeded the Misr 3 cultivar in chlorophyll content in both seasons.

Foliar spraying by antioxidants resulted in a highly significant increase in chl a, and b content in the two seasons compared to control treatment (Table 3).

Application of ascorbic acid (ASA) produced the highest values of chl. a (13.34 and 14.51  $\mu\text{g ml}^{-1}$ ), followed by silicate potassium (10.92 and 13.24  $\mu\text{g ml}^{-1}$ ), and lowest one were obtained by control treatments (7.51 and 10.86  $\mu\text{g ml}^{-1}$ ) in the first and second seasons, respectively. Also, the results are similar for chl. b content. However, there was no significant difference between spraying salicylic acid and potassium silicate in the second season for each of chlorophyll content.

The attained results in Table (3) indicated that, the interactions between soil salinity and cultivars on chlorophyll content. It was found that there was an insignificant difference for chl. a in both seasons, and chl. b in the 1<sup>st</sup> season. A significant difference in the second season for chl. b in the first season was found. The highest values of Sakha 95 cultivar were in the normal soil. Under the saline soil, Misr 3 gave the lowest mean values.

A positive significant difference was found due to the interactions between soil salinity and foliar spraying in chlorophyll content (Table 3). Chlorophyll (a) decreased by 25.98 and 22.91%, and chlorophyll (b) 35.80 and 15.54%.

Table (3) indicates the interactions between cultivars and foliar spraying of chlorophyll content, as it shows that there is a significant difference for chl. a and b in both seasons, but in the second season had insignificant difference in chlorophyll (a). The highest mean values of chlorophyll content were achieved with c.v Sakha 95 + ascorbic acid spray treatment, followed by c.v Misr 3 with ascorbic acid spray treatment; while c.v Misr 3 without foliar spray gave the lowest values.

Proceeding Book of ISESER 2023

**Table 3.** Biochemical characteristics of the two wheat cultivars as affected by soil salinity and foliar spraying with some antioxidants in 2020/21 and 2021/22 seasons.

Factors	Chl. a ( $\mu\text{g ml}^{-1}$ )		Chl. b ( $\mu\text{g ml}^{-1}$ )		Proline ( $\text{mg g}^{-1}\text{FW}$ )		POD ( $\mu\text{mol min}^{-1}\text{g protein}^{-1}$ )		CAT ( $\mu\text{mol min}^{-1}\text{g protein}^{-1}$ )		
	2020/21	2021/22	2020/21	2021/22	2020/21	2021/22	2020/21	2021/22	2020/21	2021/22	
<b>Seasons</b>											
<b>Soil salinity(A)</b>											
Normal	10.97a	13.30a	4.57a	6.10a	0.250b	0.257b	2.27b	2.32b	0.148b	0.156b	
Saline	9.68b	12.35b	3.52b	4.88b	0.257a	0.265a	2.42a	2.47a	0.156a	0.164a	
F-test	**	**	**	**	**	**	**	**	**	**	
<b>Cultivars (B)</b>											
Sakha 95	10.68a	13.15a	4.32a	5.89a	0.250b	0.256b	2.37a	2.43a	0.153a	0.161a	
Misir 3	9.97b	12.50b	3.77b	5.10b	0.257a	0.266a	2.32b	2.37b	0.151b	0.159b	
F-test	**	*	**	**	**	**	**	**	**	**	
<b>Foliar spray (C)</b>											
Control	7.51d	10.86c	2.00d	4.26c	0.237d	0.240d	2.00d	2.02d	0.130d	0.136d	
ASA	13.34a	14.51a	6.78a	7.66a	0.268a	0.281a	2.72a	2.79a	0.173a	0.182a	
SA	9.55c	12.68b	3.08c	4.79bc	0.251c	0.257c	2.23c	2.28c	0.146c	0.152c	
K <sub>2</sub> SiO <sub>3</sub>	10.92b	13.24b	4.32b	5.25b	0.257b	0.266b	2.44b	2.50b	0.160b	0.171b	
F-test	**	**	**	**	**	**	**	**	**	**	
<b>Bilateral interaction</b>											
<b>Soil salinity (A)</b>	<b>Cultivars (B)</b>										
Normal	Sakha 95	11.33	13.51	4.94	6.69a	0.247	0.254	2.3	2.36c	0.150b	0.158b
	Misir 3	10.62	13.09	4.19	5.51bc	0.253	0.26	2.25	2.29d	0.146c	0.154c
Saline	Sakha 95	10.04	12.79	3.7	5.08cd	0.253	0.259	2.45	2.49a	0.156a	0.165a
	Misir 3	9.33	11.91	3.34	4.68d	0.261	0.271	2.39	2.45b	0.155a	0.164a
F-test		ns	ns	ns	*	ns	ns	ns	**	**	*
<b>Soil salinity(A)</b>	<b>Foliar spray (C)</b>										
Normal	Control	8.37g	11.98e	2.30f	4.57de	0.231g	0.233f	1.91h	1.93h	0.127h	0.131
	ASA	14.23a	14.94a	8.03a	9.57a	0.263b	0.274b	2.66b	2.73b	0.169b	0.177
	SA	9.89e	12.82cd	3.27e	4.89cd	0.250e	0.256de	2.21f	2.25f	0.143f	0.148

**Proceeding Book of ISESER 2023**

	K <sub>2</sub> SiO <sub>3</sub>	11.40c	13.47b <sub>c</sub>	4.67c	5.38bc	0.256c <sub>d</sub>	0.265b <sub>c</sub>	2.32d	2.38d	0.155d	0.166
Saline	Control	6.65h	9.75f	1.69g	3.96e	0.244f	0.247e	2.09g	2.12g	0.133g	0.139
	ASA	12.44b	14.08b	5.53b	5.75b	0.273a	0.288a	2.78a	2.84a	0.177a	0.185
	SA	9.20f	12.55d <sub>e</sub>	2.88e	4.70cd	0.253d <sub>e</sub>	0.259c <sub>d</sub>	2.25e	2.31e	0.148e	0.156
	K <sub>2</sub> SiO <sub>3</sub>	10.44d	13.02c <sub>d</sub>	3.97d	5.12bc <sub>d</sub>	0.258c	0.266b <sub>c</sub>	2.57c	2.62c	0.164c	0.175
F-test		**	*	**	**	**	*	**	**	**	ns
<b>Cultivars (B)</b>	<b>Foliar spray (C)</b>										
Sakha 95	Control	7.99g	11.72	2.14e	4.54e	0.234g	0.236f	2.04g	2.06	0.13g	0.135g
	ASA	13.91a	14.82	7.49a	8.86a	0.261b	0.269b	2.75a	2.81	0.174a	0.183a
	SA	9.75e	12.73	3.19d	4.83de	0.250e	0.255d	2.24e	2.3	0.147e	0.155e
	K <sub>2</sub> SiO <sub>3</sub>	11.09c	13.32	4.45c	5.31c	0.256c <sub>d</sub>	0.265b <sub>c</sub>	2.47c	2.52	0.162c	0.172c
Misr 3	Control	7.03h	10	1.85e	3.98f	0.241f	0.245e	1.96h	1.98	0.130g	0.137g
	ASA	12.77b	14.21	6.07b	6.46b	0.275a	0.292a	2.69b	2.76	0.172b	0.180b
	SA	9.34f	12.63	2.96d	4.76e	0.253d <sub>e</sub>	0.260c <sub>d</sub>	2.21f	2.25	0.144f	0.150f
	K <sub>2</sub> SiO <sub>3</sub>	10.75d	13.16	4.20c	5.19cd	0.258b <sub>c</sub>	0.266b <sub>c</sub>	2.42d	2.46	0.158d	0.169d
F-test		*	ns	*	**	**	**	**	ns	*	**

\*Note: \*and\*\* indicate a significant difference and NS indicates an insignificant difference at  $P<0.01$ . Different lowercase letters in the column indicate a significant difference between the treatments, while the same letters show no statistical difference at  $P<0.01$  (Duncan's multiple range test).

Proceeding Book of ISESER 2023

**Table 4.** Interaction effect of soil salinity, wheat cultivars and foliar spray on biochemical characteristics in the 2020/21 and 2021/22 seasons.

Factors			Chl. a ( $\mu\text{g ml}^{-1}$ )		Chl. b ( $\mu\text{g ml}^{-1}$ )		Proline ( $\text{mg g}^{-1}\text{FW}$ )		POD ( $\mu\text{mol min}^{-1} \text{g protein}^{-1}$ )		CAT ( $\mu\text{mol min}^{-1} \text{g protein}^{-1}$ )	
Soil salinity(A)	Seasons Cultivars (B)	Foliar spray (C)	2020/21	2021/22	2020/21	2021/22	2020/21	2021/22	2020/21	2021/22	2020/21	2021/22
			Normal	Control	8.71k	12.17fgh	2.5	4.60de	0.227m	0.227	1.96k	1.98m
	ASA	14.88a	15.42a	8.99	11.78a	0.260cd	0.268	2.67c	2.75c	0.170c	0.178c	
	Sakha 95	SA	10.12h	12.86defg	3.44	4.93de	0.249ij	0.254	2.21h	2.29i	0.145i	0.152g
		K <sub>2</sub> SiO <sub>3</sub>	11.61e	13.59bcd	4.84	5.46cde	0.254fghi	0.265	2.34f	2.41g	0.158f	0.168e
	Control	8.03l	11.79gh	2.1	4.54e	0.236l	0.239	1.85l	1.88n	0.124m	0.130j	
	ASA	13.59b	14.47ab	7.06	7.36b	0.266b	0.28	2.64c	2.71d	0.167d	0.177cd	
	Misir 3	SA	9.66i	12.78efg	3.1	4.85de	0.252ghi	0.257	2.20h	2.21j	0.142j	0.145h
		K <sub>2</sub> SiO <sub>3</sub>	11.19f	13.34bcd	4.5	5.30cde	0.257cde	0.265	2.30g	2.34h	0.152g	0.164e
	Control	7.26m	11.27h	1.79	4.49e	0.241k	0.244	2.11i	2.14k	0.130l	0.137i	
	ASA	12.95c	14.21bc	5.99	5.94c	0.262bc	0.271	2.83a	2.87a	0.178a	0.189a	
	Sakha 95	SA	9.38i	12.61efg	2.94	4.74de	0.252hi	0.255	2.27g	2.32hi	0.150h	0.157f
		K <sub>2</sub> SiO <sub>3</sub>	10.57g	13.06cdef	4.06	5.17cde	0.257def	0.265	2.60d	2.65e	0.165de	0.176cd
	Control	6.03n	8.22i	1.6	3.42f	0.246jk	0.251	2.07j	2.09l	0.136k	0.143h	
	ASA	11.94d	13.94bcd	5.07	5.56cd	0.284a	0.304	2.73b	2.81b	0.176b	0.183b	
	Misir 3	SA	9.02j	12.49efg	2.82	4.67de	0.254efg	0.263	2.23h	2.31i	0.146i	0.155fg
		K <sub>2</sub> SiO <sub>3</sub>	10.30g	12.97def	3.89	5.07cde	0.259cde	0.266	2.54e	2.59f	0.164e	0.174d
F-test			*	*	ns	**	**	ns	**	**	**	**

\*Note: \*and\*\* indicate a significant difference and NS indicates an insignificant difference at  $P<0.01$ . Different lowercase letters in the column indicate a significant difference between the treatments, while the same letters show no statistical difference at  $P<0.01$  (Duncan's multiple range test).

## **Proceeding Book of ISESER 2023**

The interactions between soil salinity, cultivars and foliar spraying of chlorophyll content, as the Table (4) indicated that there are positive affect chl. a, and b in both seasons, and there are insignificant difference in the 1st season of chlorophyll (b). The best treatment was ascorbic acid foliar spray with Sakha 95 under the influence of normal or salinity soil.

### **3.1.2. The content of some enzymes in the leaves:**

The content of some enzymes in leaves was strongly affected by soil salinity. The saline soil increased considerably the values of proline, peroxidase activity (POD), and catalase activity (CAT) compared to normal soil (Table 3).

With regard to wheat cultivars, results in Table 3 revealed highly significant differences existed between Misr 3 and Sakha 95. Sakha 95 had a significantly higher activity of (POD) and (CAT) enzymes. While, the proline content was higher with Misr 3.

Foliar spraying treatments caused an observed increase in proline, (POD), and (CAT) activity compared to untreated plants (control). Ascorbic acid recorded the highest increase in the content of proline, (POD), and (CAT), followed by potassium silicate, while the lowest increase was obtained with salicylic acid.

The soil salinity  $\times$  cultivars interaction is positive about the CAT content in both seasons. However, insignificant effects on proline content in both seasons and in the 1<sup>st</sup> season with POD, while in the 2<sup>nd</sup> season was highly significant as shown in Table 3.

Table (3) illustrates that, the interaction between soil salinity and foliar spray on the content of some enzymes in the leaves. Ascorbic acid more effective foliar spray treatment under normal and saline soil condition than that, the other foliar spray treatments (SA and  $K_2SiO_3$ ).

Concerning the interaction of cultivars and foliar spray, the results in Table (3) show that there is a difference in the content of some enzymes in leaves of both cultivars. The highest proline content (0.275 and 0.292 mg g<sup>-1</sup>FW) were observed with Misr 3 c.v + foliar spray by ASA. While, Sakha 95 with spraying ASA gave the highest mean values of POD (2.75 and 2.81  $\mu\text{mol min}^{-1} \text{g protein}^{-1}$ ) and CAT (0.174 and 0.183  $\mu\text{mol min}^{-1} \text{g protein}^{-1}$ ). Insignificant differences in the POD content values in the second season were detected.

Under saline soil condition, the data in Table (4) show that the highest proline content values were obtained with Misr 3 c.v + foliar spray by ASA. While, the highest mean values of POD and CAT were recorded with Sakha 95 + ASA foliar spraying.

## **3.2. Grain yield and its chemical analysis:**

### **3.2.1. Grain yield**

Grain yield of the two wheat cultivars as affected by soil salinity and foliar spray, and their interaction in the 2020/21 and 2021/22 seasons are presented in Table (5). Data showed that the soil salinity resulted in a highly negative effect on grain yield in both seasons. Soil salinity caused a marked reduction in grain yield by 17.86 and 18.34% compared with normal soil in the two seasons, respectively.

The results indicated that, Sakha 95 cultivar exceeded the Misr 3 cultivar in grain yield in both seasons, which the grain yield increased an average of both seasons by 13%, respectively.

Foliar spraying treatments caused an observed increase in grain yield compared to untreated plants (control). Ascorbic acid recorded the highest increases in the grain yield, followed by potassium silicate, while, the lowest increase was obtained with salicylic acid Table (5).

The soil salinity  $\times$  cultivars interaction is insignificant affect the grain yield of wheat in both seasons (Table 5).

Table (5) refers that the interaction between soil salinity and foliar spray on the grain yield. Ascorbic acid more effective foliar spray treatment under normal and saline soil conditions than that other foliar spray treatments (SA and  $K_2SiO_3$ ).

Concerning the interaction of cultivars and foliar spray, the results in Table (5) show that there is a difference in the grain yield of both cultivars. The highest grain yield was observed with Sakha 95 c.v +

**Proceeding Book of ISESER 2023**

foliar spray by ASA. While, Misr 3 without spraying gives the lowest values.

For the interaction of soil salinity, cultivars and foliar spray, data shown in Table (6) indicate highly significant differences for grain yield in both seasons. The greatest values were obtained from foliar spray by ASA + Sakha 95 under the normal or /and saline condition.

**3.2.2. Chemical analysis of grain:**

Data presented in Tables (5 and 6) show the effect of soil salinity, wheat cultivars, foliar spray and their interaction on chemical analysis of grain wheat.

All Chemical analysis of grain, e.g. carbohydrates%, protein, Na%, P and K showed pronounced effects under salt stress (Table 5). Results reference that P and K were reduced and they had high significantly with salinity compared to unstressed condition (normal soil). While, the main values of carbohydrates, protein and Na% were highly significant increased with soil salinity in both seasons.



Proceeding Book of ISESER 2023

**Table 5.** Grain yield and chemical analysis of grains of the two wheat cultivars as affected by soil salinity and foliar spraying with some antioxidants in 2020/21 and 2021/22 seasons.

Factors		Grain yield (ton fed <sup>-1</sup> )		Carbohedrat %		Protein%		Na%		P%		K%			
Seasons		2020/21	2021/22	2020/21	2021/22	2020/21	2021/22	2020/21	2021/22	2020/21	2021/22	2020/21	2021/22		
<b>Soil salinity(A)</b>															
Normal		1.98a	2.00a	72.59b	72.87b	9.56b	9.55b	1.17b	1.10b	0.378a	0.383a	0.951a	0.98a		
Saline		1.68b	1.69b	73.86a	74.02a	11.00a	10.57a	1.26a	1.20a	0.368b	0.372b	0.874b	0.90b		
F-test		**	**	**	**	**	**	**	**	**	**	**	**		
<b>Cultivars (B)</b>															
Sakha 95		1.94a	1.96a	73.59a	73.78a	9.82b	9.75b	1.17b	1.11b	0.376a	0.380a	0.946a	0.96a		
Misr 3		1.72b	1.73b	72.87b	73.11b	10.75a	10.38a	1.26a	1.19a	0.371b	0.375b	0.889b	0.92b		
F-test		**	**	**	**	**	**	**	**	**	**	**	**		
<b>Foliar spray (C)</b>															
Control		1.16d	1.19d	69.55d	70.74d	7.88d	7.66d	1.46a	1.37a	0.351d	0.356c	0.75d	0.76d		
ASA		2.53a	2.54a	76.16a	76.19a	13.72a	12.57a	1.04d	0.97d	0.392a	0.395a	1.14a	1.18a		
SA		1.67c	1.69c	72.65c	72.80c	8.70c	9.66c	1.23b	1.15b	0.371c	0.376b	0.83c	0.84c		
K <sub>2</sub> SiO <sub>3</sub>		1.95b	1.98b	74.54b	74.06b	10.84b	10.36b	1.13c	1.10c	0.379b	0.383b	0.94b	0.98b		
F-test		**	**	**	**	**	**	**	**	**	**	**	**		
<b>Bilateral interaction</b>															
<b>Soil salinity (A)</b>		<b>Cultivars (B)</b>													
Normal		Sakha 95		2.08	2.12	73.05c	73.2	9.17	9.13	1.15	1.08b	0.379	0.385	0.98a	1
		Misr 3		1.88	1.89	72.14d	72.54	9.96	9.97	1.19	1.12b	0.377	0.381	0.92b	0.95
Saline		Sakha 95		1.8	1.8	74.12a	74.36	10.46	10.36	1.2	1.14ab	0.372	0.375	0.89bc	0.92
		Misr 3		1.57	1.58	73.60b	73.68	11.55	10.79	1.33	1.25a	0.365	0.369	0.86c	0.88
F-test				ns	ns	*	ns	ns	ns	ns	*	ns	ns	**	ns
<b>Soil salinity(A)</b>		<b>Foliar spray (C)</b>													
Normal		Control		1.39g	1.42f	68.03h	69.80h	7.61f	7.06f	1.33b	1.24b	0.361f	0.367f	0.78f	0.80f
		ASA		2.77a	2.80a	75.84b	75.60b	12.23b	11.83b	1.01f	0.95d	0.396a	0.400a	1.20a	1.24a
		SA		1.70e	1.74e	72.26f	72.47f	8.15f	9.52d	1.21bcd	1.12c	0.374d	0.379d	0.84e	0.85e
		K <sub>2</sub> SiO <sub>3</sub>		2.04c	2.06c	74.25d	73.62d	10.28d	9.79d	1.12def	1.07cd	0.381c	0.385bc	0.98c	1.02c
Saline		Control		0.94h	0.96g	71.07g	71.69g	8.15f	8.26e	1.60a	1.49a	0.341g	0.345g	0.72g	0.72g
		ASA		2.29b	2.27b	76.49a	76.77a	15.21a	13.31a	1.08ef	1.00d	0.389b	0.389b	1.07b	1.11b
		SA		1.64f	1.64e	73.05e	73.13e	9.24e	9.79d	1.24bc	1.18bc	0.368e	0.374e	0.82ef	0.84e
		K <sub>2</sub> SiO <sub>3</sub>		1.86d	1.89d	74.83c	74.50c	11.41c	10.94c	1.14cde	1.12c	0.377cd	0.380cd	0.89d	0.94d
F-test				**	**	**	**	**	**	**	**	**	**	**	**
<b>Cultivars (B)</b>		<b>Foliar spray (C)</b>													
Sakha 95		Control		1.32f	1.35e	70.42g	71.37g	7.61f	7.06	1.33	1.27b	0.356d	0.361e	0.77	0.78
		ASA		2.73a	2.73a	76.38a	76.53a	12.63b	12.27	1.03	0.95e	0.394a	0.397a	1.17	1.22
		SA		1.69e	1.71d	72.76ef	73.00e	8.42de	9.52	1.22	1.14c	0.372c	0.377d	0.84	0.85
		K <sub>2</sub> SiO <sub>3</sub>		2.01c	2.05c	74.78c	74.23c	10.60c	10.13	1.12	1.08cd	0.380b	0.383c	0.96	1.01
Misr 3		Control		1.01g	1.03f	68.69h	70.11h	8.15ef	8.26	1.6	1.47a	0.346e	0.351f	0.73	0.73
		ASA		2.34b	2.34b	75.94b	75.84b	14.81a	12.87	1.06	1.00de	0.390a	0.392b	1.1	1.14
		SA		1.65e	1.66d	72.55f	72.60f	8.97d	9.79	1.24	1.16c	0.370c	0.375d	0.82	0.84
		K <sub>2</sub> SiO <sub>3</sub>		1.89d	1.91c	74.29d	73.89d	11.09c	10.6	1.14	1.11c	0.378b	0.382c	0.91	0.95
F-test				**	*	**	**	**	ns	ns	**	*	**	ns	ns

\*Note: \*and\*\* indicate a significant difference and NS indicates an insignificant difference at  $P<0.01$ . Different lowercase letters in the column indicate a significant difference between the treatments, while the same letters show no statistical difference at  $P<0.01$  (Duncan's multiple range test).

Proceeding Book of ISESER 2023

**Table 6.** Interactions between soil salinity, cultivars and foliar spray on grain yield and chemical analysis of grains during 2020/21 and 2021/22 seasons.

Factors			Grain yield (ton fed <sup>-1</sup> )		Carbohedrat %		Protein%		Na%		P%		K%	
Soil salinity(A)	Seasons	Cultivars (B)	2020/21	2021/22	2020/21	2021/22	2020/21	2021/22	2020/21	2021/22	2020/21	2021/22	2020/21	2021/22
					1	2	1	2					1	2
Normal	Sakha 95	Control	1.44h	1.47hi	69.29k	70.77l	7.06f	5.98f	1.29bc	1.24bc	0.360h	0.369ij	0.80fg	0.80hi
		ASA	3.05a	3.09a	76.03bc	75.69bc	11.68c	11.51b	1.00f	0.91f	0.398a	0.404a	1.26a	1.30a
	Misr 3	SA	1.72fg	1.77fg	72.36h	72.62hi	8.15e	9.25d	1.19cde	1.12bcd	0.374ef	0.380efg	0.84ef	0.86g
		K <sub>2</sub> SiO <sub>3</sub>	2.09cd	2.13cd	74.52e	73.72f	9.79d	9.79cd	1.12def	1.04def	0.383cd	0.386cde	1.03c	1.06d
	Sakha 95	Control	1.35hi	1.36ij	66.78l	68.82m	8.15e	8.15e	1.37b	1.24bc	0.362h	0.365j	0.77g	0.80hi
		ASA	2.50b	2.52b	75.64c	75.51c	12.77b	12.15b	1.02f	1.00ef	0.394ab	0.396b	1.14b	1.19b
Saline	Sakha 95	SA	1.68fg	1.70fg	72.16h	72.31ij	8.15e	9.79cd	1.24bcd	1.12bcd	0.373ef	0.378fgh	0.84ef	0.84gh
		K <sub>2</sub> SiO <sub>3</sub>	1.99d	2.00cde	73.97f	73.52f	10.76cd	9.79cd	1.12def	1.11cde	0.379de	0.384cde	0.94d	0.99e
	Misr 3	Control	1.20i	1.23j	71.55j	71.97j	8.15e	8.15e	1.37b	1.29b	0.349i	0.354k	0.75gh	0.77i
		ASA	2.41b	2.37b	76.73a	77.36a	13.58b	13.04a	1.07ef	1.00ef	0.391b	0.391bc	1.08bc	1.14bc
	Sakha 95	SA	1.66fg	1.65fgh	73.16g	73.37fg	8.70e	9.79cd	1.24bcd	1.16bcd	0.370fg	0.374ghi	0.84ef	0.84gh
		K <sub>2</sub> SiO <sub>3</sub>	1.92de	1.96de	75.04d	74.75d	11.41c	10.47c	1.12def	1.12bcd	0.377de	0.381def	0.89de	0.95ef
Misr 3	Control	0.67j	0.70k	70.59j	71.41k	8.15e	8.37e	1.82a	1.70a	0.332j	0.337l	0.69h	0.67j	
	ASA	2.18c	2.17c	76.24b	76.17b	16.84a	13.58a	1.09def	1.00ef	0.387bc	0.388cd	1.06c	1.10cd	
Misr 3	SA	1.62g	1.62gh	72.94g	72.89fg	9.79d	9.79cd	1.24bcd	1.20bcd	0.366gh	0.373hi	0.80fg	0.84gh	
	K <sub>2</sub> SiO <sub>3</sub>	1.80ef	1.82ef	74.61de	74.25e	11.41c	11.41b	1.16cde	1.12bcd	0.376de	0.380efg	0.89de	0.92f	
F-test			**	**	**	**	**	**	**	*	*	*	*	

\*Note: \*and\*\* indicate a significant difference and NS indicates an insignificant difference at  $P<0.01$ . Different lowercase letters in the column indicate a significant difference between the treatments, while the same letters show no statistical difference at  $P<0.01$  (Duncan's multiple range test).

### **Proceeding Book of ISESER 2023**

The results presented in Table (5) introduced significant differences in the chemical analysis of grain across in both seasons. Sakha 95 cultivars significantly surpassed Misr 3 in carbohydrates%, P and K. While, Misr 3 produced more protein and Na% than Sakha 95.

Foliar spraying was accompanied by a significant increase in selected chemical analysis of grain than that of untreated plants (control). Application of ascorbic acid (ASA) produced increasing the mean values of carbohydrates (9.50 and 7.70%), protein (74.11 and 64.10%), P (11.68 and 10.96%) and K (52.00 and 55.26%) in the 1<sup>st</sup> and 2<sup>nd</sup> seasons, respectively. While, the mean values of Na% were decreased by 28.77 and 29.20% in both seasons compared with control (untreated plants).

Table (5) indicates the interactions between soil salinity and cultivar in chemical analysis of grain, where it was found that there were insignificant affects the carbohydrates and K in the 2<sup>nd</sup> season and also, the P and protein no significant differences in both seasons. In general, the mean values of carbohydrates and Na% content were increased with Misr 3 under saline soil, while Sakha 95 cultivars significantly exceed Misr 3 in K% under different salinity conditions (Table 5).

The application of ASA recorded the best treatment for counteracting salinity stress in terms of the chemical analysis of grain. Highly significant differences were found in the first and two seasons due to the interactions between soil salinity and foliar spray in the all chemical analysis (Table 5).

Concerning the interaction of soil salinity and foliar spraying, the results in Table (5) show that there is a highly significant difference for all chemical analysis in both seasons. Foliar spray with ascorbic acid under salinity stress condition increased carbohydrates and protein compared the unstressed condition, while, P and K were increased under normal than that saline soil. Na% decreased significantly under unstressed and salinity stress conditions.

Regarding the combinations between cultivars and foliar spray, the data illustrated in Table (5) clearly indicate that antioxidants foliar application, especially ascorbic acid with Sakha 95 gave a highest mean values of carbohydrates (76.38 and 76.53 %) and P (0.394 and 0.397%). While the highest mean values of protein and Na content with Misr 3 + ascorbic acid spray or/and without spray treatments.

The interactions between soil salinity and cultivars and foliar spraying, as shown in Table (6). The highest mean values of protein content were produced with Misr 3 + ascorbic acid foliar sprays under saline soil, and Na% in both seasons were achieved with Misr 3 + control (untreated plants) under saline soil. While the maximum carbohydrates, P and K% were obtained with ascorbic acid foliar spray + Sakha 95 under normal soil.

## **4. DISCUSSION**

### **Chlorophyll content:**

Data showed that the soil salinity resulted in a highly negative effect on Chlorophyll content (a, b and t). The decrease in the content of photosynthetic pigments might be attributed to damage to protein complexes and/or chlorophyll molecules Siddiqui *et al.*, (2018). ASA Foliar spraying treatments caused an observed increase in Chlorophyll content (a and b) compared to untreated plants (control). These results agreed with Azzedine *et al.*, (2011) found that applying ascorbic acid was improving chlorophyll under saline stress. Also, Siddiqui *et al.*, (2018) noted that ascorbic acid significantly improved the accumulation of chlorophyll content in wheat plants under non-stress and stress conditions. Interactions between soil salinity and cultivars on chlorophyll content were found that the highest values of Sakha 95 cultivars were under un-stress condition, while Misr 3 gave the lowest mean values under salt stress condition. These findings are in agreement, Abd El-Hamid *et al.*, (2020), Genedy and Eryan (2022), Elsayy *et al.*, (2023) and Khedr *et al.*, (2023), which they specified that the Sakha 95 cultivars exceeded Misr3 cultivar in chlorophyll contents. Foliar spray by ascorbic acid declined the

### **Proceeding Book of ISESER 2023**

salinity stress on chlorophyll content more efficiently than the other foliar spray treatment.

The interactions between soil salinity and foliar spraying resulted in a decrease in chlorophyll content, due to salinity stress under control treatment in the two seasons, respectively. The interactions between cultivars and foliar spraying of chlorophyll content indicated that, the behavior of foliar spraying of chlorophyll content differed for cultivars to another. Regarding the interactions between soil salinity, cultivars and foliar spraying of chlorophyll content (a and b), the effect of the second order interaction on that trait was significant in both seasons, except, Chl. b in the first season, indicated that these treatments are dependable on each others in their influence on this character.

#### **The content of some enzymes in the leaves:**

The content of some enzymes in leaves was strongly affected by soil salinity. These results agreed with the result obtained by Lee *et al.*, (2001) and Khedr *et al.*, (2023) they observed that under saline stress, plants induce an excess of reactive oxygen species (ROS) which causes oxidative stress of lipid cell membranes. The soil salinity  $\times$  cultivars interaction is a positive effect on the content of some enzymes in the leaves. It seems that, the first order did not affected by changing the other environment. These agreed with Genedy and Eryan (2022) and Khedr *et al.*, (2023).

Concerning the interaction between soil salinity and foliar spray on the content of some enzymes in the leaves. The results indicated that, foliar spray by AsA was effective under non-stress and salt stress condition. In agreement with the findings of Abbasi and Faghani (2015), Desoky and Merwad (2015), and Hassan and Bano (2016) they refer that the application of ascorbic acid increments proline in plants under saline conditions for wheat. Also Agami (2014), Hassan and Bano (2016) and Gerami *et al.*, (2019) found that under salt-stressed conditions, the ascorbic acid application led to an increase in CAT and POD activities. Concerning the interaction effect of soil salinity, wheat cultivars and foliar spray on the content of some enzymes in the leaves, the results showed that the highest proline content values were obtained with Misr 3 cultivar + foliar spray by (ASA). While, the highest mean values of (POD) and (CAT) were recorded with Sakha 95 cultivar + spraying by ascorbic acid. The results were agreeing with data obtained by Mandhania *et al.*, (2012) found that the activities of catalase activity (CAT) increased with increasing the salt stress in both salt tolerant and salt sensitive wheat cultivars.

#### **Grain yield:**

Data showed that the soil salinity resulted in a highly negative effect on grain yield in both seasons, which caused a marked reduction in grain yield compared with normal soil. The results agreed with Hasan *et al.*, (2015) and Nadeem *et al.*, (2020) which indicated a negative effect of salinity on grain yield. In addition, losses in grain weight due to saline stress are due to pollen sterility, reduced production of assimilates, and reduced partitioning to economical parts (grains) of plants (Dadshani *et al.*, 2019). The results indicated that, Sakha 95 cultivar exceeded the Misr 3 cultivar in grain yield in both seasons. It seems that, wheat yields had affected by among cultivar to another. Foliar spraying treatments caused an observed increase in grain yield compared to untreated plants (control). Ascorbic acid recorded the highest increases in the grain yield. This result agreed with El-Awadi *et al.*, (2014) found that the treatment of wheat plants with foliar spraying of ascorbic acid resulted in an increase in the grain yield.

The soil salinity  $\times$  cultivars interaction is positive affect the grain yield of wheat. Those findings agreed with Abd El-Hamid *et al.*, (2020), Genedy and Eryan (2022), Elsayy *et al.*, (2023) and Khedr *et al.*, (2023). Ascorbic acid more effective foliar spray treatment under normal and saline soil conditions than that other foliar spray treatments. These results

**Proceeding Book of ISESER 2023**

agreement with Fawy and Attia (2013) and Bakry *et al.*, (2013) and they mention that application of ascorbic acid spray led to increases in grain yield under stress condition. It seems that, soil salinity affected by changing foliar spray treatments.

Concerning the interaction of cultivars and foliar spray, the results showed that the highest grain yield were observed with Sakha 95 c.v + foliar spray by ascorbic acid (ASA). It seems that, wheat cultivars had affected by changing foliar spray treatments. The interaction of soil salinity, cultivars and foliar spray, data indicated that the greatest values of grain yield were obtained from foliar spray by ascorbic acid (ASA) + Sakha 95 under the saline condition. These significant interactions among these characters indicated that, these factors are dependable on each of the others in their influences.

**Chemical analysis of grain:**

The chemical analysis of grains was strongly affected by soil salinity. It may be due to the salinity increases the percentage of Na produced from soil salts such as NaCl, which in turn works to increase the osmotic pressure in the plant and thus an increase in electrical conductivity. The results agreed with Zhong *et al.*, (2016) who noted the salt stress affects caused the metabolism of carbohydrates and the translocation that causes the build-up of starch and sugars (*et al.*, 2016). Also, the increase in total carbohydrate content under salinity stress is consistent with results found by Hassan and Bano (2016), Zhong *et al.*, (2016) and Mohamed *et al.*, (2018). Also, the soil salinity led to increased protein and Na content, this may be related to the relatively stable nitrogen metabolism under salt stress, which might contribute to the higher protein concentration (Abd El-Hamid *et al.*, 2020). While Na uptake causes a decrease in P and K uptake by wheat plants, The results agreed with Nadeem *et al.*, (2020) who noted the negative impact of salinity on nutrient content in wheat plants. Foliar spraying by (AsA) caused an observed increase in carbohydrates, P, K and protein content compared to untreated plants (control). While it led to decreased Na. It seems that, the first order affected by changing the foliar spray.

The soil salinity × cultivars interaction a highly negative effect on the chemical analysis of grain. Zheng *et al.*, (2009) referred that the protein content of cultivars under study increased as salt concentration increase. The results indicated that, Misr 3 produced more protein and Na%. While Sakha 95 cultivars significantly surpassed Misr 3 in carbohydrates%, P and K. The data showed also the exceed Sakha 95 than Misr 3 under unstressed and salinity stress conditions. These results agreed with Abd El-Hamid *et al.*, (2020) and Ibrahim *et al.*, (2022). The results of this study agree with the results obtained by Abd El-Hamid *et al.*, (2020) and Elsayy *et al.*, (2023). The results indicated that, the attitude of these traits differed from cultivar to another. Concerning the interaction of soil salinity and foliar spraying, the results showed that foliar spraying by ascorbic acid recorded the best treatment for withstanding salt stress. Results agreed with Ishaq *et al.*, (2021). This result may be due to the effectiveness of the antioxidant system in the removal of ROS from plants and the maintenance of ion homeostasis (Athar and Ashraf 2008). Also, Azza *et al.*, (2011) stated that the promoting effect of ascorbic acid on total carbohydrates may be due to their important role in the biosynthesis of chlorophyll molecules which in turn affected total carbohydrate content. For the interactions between cultivars and foliar spray are positive effect on the chemical analysis of grain. It seems that, wheat cultivars had affected by changing foliar spray treatments, except, protein content in the first season, P% in the second season and K% in both seasons. Regarding interactions between soil salinity, cultivars, and foliar spray of the chemical analysis of grain, it showed that the highest results were in favor of Sakha 95 with ascorbic acid under un-stress and salt stress condition except, protein and Na% were achieved with Misr 3 + (AsA) foliar spray or/ and untreated plant under saline soil. It indicated that these treatments are dependable on each others in their influence on these traits.

## 5. CONCLUSIONS

It can conclude that the foliar spraying using ascorbic acid at a rate of 200 mg L<sup>-1</sup> is most effective ways for increasing wheat productivity and alleviate the damage effects of salinity on the wheat plants. Therefore, it is recommended to plant Sakha 95 cultivars, due to its superiority tolerance to salinity as well as foliar spraying using ascorbic acid.

**Author Contributions:** Conceptualization, E.H.E., E.N.M.M. and S.H.Kh.; methodology, E.H.E., and S.H.Kh.; software, E.N.M.M.; validation, E.H.E. and E.N.M.M.; formal analysis, E.H.E., and S.H.Kh.; investigation, E.H.E., and S.H.Kh.; resources, E.H.E., and S.H.Kh.; data curation, E.H.E., E.N.M.M. and S.H.Kh.; writing original draft preparation, E.N.M.M. and S.H.Kh.; writing review and editing, E.H.E.; visualization, E.N.M.M. and S.H.Kh.; supervision, E.H.E. All authors have read and agreed to the published version of the manuscript. All authors have read and agreed to the published version of the manuscript.

**Funding:** This research received no external funding.

**Institutional Review Board Statement:** Not applicable.

**Informed Consent Statement:** Not applicable.

**Data Availability Statement:** The data that supports the findings of this study are contained within the article and available from the corresponding author upon reasonable request.

**Acknowledgments:** The authors would like to appreciate to both of the Faculty of Agriculture, Tanta University and Sakha Agricultural Research Station, Agriculture Research Center (ARC) for their assistance for this work

**Conflicts of Interest:** The authors declare no conflict of interest.

## REFERENCES

- A.O.A.C. (1990). Official Methods of Analysis of the Association of Official Chemists, 15<sup>th</sup> Edition, published by Association of Official Analytical Chemists Arlington, Virginia, U.S.A.
- Abbasi, M. and Faghani, E. (2015). Role of salicylic acid and ascorbic acid in the alleviation of salinity stress in wheat (*Triticum aestivum* L.). J. Bio. Environ. Sci., 6(2): 107-113.
- Abd El-Hamid, E.A.M., El-Hawary, M.N.A., Khedr, R.A. and Shahein, A.M. (2020). Evaluation of some bread wheat genotypes under soil salinity conditions. Journal of Plant Production, 11(2): 167-177.
- Aboelsoud, H. M., AbdelRahman, M. A., Kheir, A. M., Eid, M. S., Ammar, K. A., Khalifa, T. H. and Scopa, A. (2022). Quantitative estimation of saline-soil amelioration using remote-sensing indices in arid land for better management. Land, 11(7): 1-19.
- Agami, R. (2014). Applications of ascorbic acid or proline increase resistance to salt stress in barley seedlings. Biologia Plantarum, 58(2): 341-347.
- Ahmad, A., Afzal, M., Ahmad, A.U.H. and Tahir, M. (2013). Effect of foliar application of silicon on yield and quality of rice (*Oryza sativa* L.). Cer. Agron. Moldova., 46(3): 21-28.
- Akram, N.A., Shafiq, F. and Ashraf, M. (2017). Ascorbic acid-a potential oxidant scavenger and its role in plant development and abiotic stress tolerance. Frontiers in Plant Science, 8: 1-17.
- Arif, Y., Singh, P., Siddiqui, H., Bajguz, A. and Hayat, S. (2020). Salinity induced physiological and biochemical changes in plants: An omic approach towards salt stress tolerance. Plant Physiology and Biochemistry, 156: 64-77.
- Ashraf, M. and Munns, R. (2022). Evolution of approaches to increase the salt tolerance of crops. Critical Reviews in Plant Sciences, 41(2): 128-160.
- Athar, K. and Ashraf, M. (2008). Exogenously applied ascorbic acid alleviates salt-induced oxidative stress in wheat. Environmental and Experimental Botany, 63(1-3): 224-231.
- Azza, A.M.M., Sahar, M.Z., Safaa, A.M. and Hanan, S.S. (2011). Stimulatory effect of kinetin, ascorbic acid and glutamic acid on growth and chemical constituents of *Codiaeum*

Proceeding Book of ISESER 2023

- variegatum* L. plant'. American-Eurasian J. Agric. And Environ. Sci., 10(3): 318-323.
- Azzedine, F., Gherroucha, H. and Baka, M. (2011). Improvement of salt tolerance in durum wheat by ascorbic acid application. J. Stress Physiol. Biochem., 7(1): 27-37.
- Bakry, B.A., Elewa, T.A., El-Kramany, M.F. and Wali, A.M. (2013). Effect of humic and ascorbic acids foliar application on yield and yield components of two wheat cultivars grown under newly reclaimed sandy soil. Intl. J. Agron. Plant Prod., 4(6): 1125-1133.
- Bates, L.S., Waldren, R.A. and Teare, I.D. (1973). Rapid determination of free proline for water-stress studies. Plant and Soil, 39: 205-207.
- Cisse, A., Arshad, A., Wang, X., Yattara, F. and Hu, Y. (2019). Contrasting impacts of long-term application of biofertilizers and organic manure on grain yield of winter wheat in North China Plain. Agronomy, 9(6): 1-15.
- Cottenie, A., Verloo M., Velghe G. and Kiekens L. (1982). Biological and analytical aspects of soil pollution. Lab. Of Analytical Agro. State Univ. Gent-Belgium.
- Dadshani, S., Sharma, R.C., Baum, M., Ogbonnaya, F.C., Leon, J. and Ballvora, A. (2019). Multi-dimensional evaluation of response to salt stress in wheat. PLoS One, 14(9): 1-24.
- Desoky, E. S.M. and Merwad, A.R.M. (2015). Improving the salinity tolerance in wheat plants using salicylic and ascorbic acids. J. Agric. Sci., 7(10): 203-217.
- Dewis, J. and Fertias, F. (1970). " Physical and chemical methods of soil and water analysis": Soil Bulletin No.10 FAO.Rome.
- Duncan, D.B. (1955). Multiple range and multiple F tests. Biometrics, 11(1): 1-42.
- El-Awadi, M.E., El-Lethy, S.R. and El-Rokiek, K.G. (2014). Effect of the two antioxidants; Glutathione and ascorbic acid on vegetative growth, yield and some biochemical changes in two wheat cultivars. Journal of Plant Sciences, 2(5): 215-221.
- El-Hawary, M.M., Hashem, O.S. and Hasanuzzaman, M. (2023). Seed priming and foliar application with ascorbic acid and salicylic acid mitigate salt stress in wheat. Agronomy, 13(2): 1-19.
- El-Hendawy, S., Elshafei, A., Al-Suhaibani, N., Alotabi, M., Hassan, W., Dewir, Y.H. and Abdella, K. (2019). Assessment of the salt tolerance of wheat genotypes during the germination stage based on germination ability parameters and associated SSR markers. Journal of Plant Interactions, 14(1):151-163.
- El-Kassas, H., Abdalla, K.S. and Ahmed, S. (2020). Enhancing salt tolerance of wheat plant (*Triticum aestivum* L.) by application of proline, ascorbic acid, arginine, glutamine and glutathione. Journal of Environmental Science, 36(3): 43-80.
- El-Sabagh, A., Islam, M.S., Skalicky, M., Ali Raza, M., Singh, K., Anwar Hossain, M., Hossain, A., Mahboob, W., Iqbal, M.A., Ratnasekera, D. and Singhal, R.K. (2021). Salinity stress in wheat (*Triticum aestivum* L.) in the changing climate: Adaptation and management strategies. Frontiers in Agronomy, 3: 1-20.
- Elsawy, H.I., Mohamed, A.M., Mohamed, E.N. and Gad, K.I. (2023). The Potential of a mixture of Zeolite, Calcium, and Organic compounds on mitigating the salinity stress in bread wheat (*Triticum aestivum* L.). Egyptian Journal of Agricultural Research, 101(2): 362-381.
- FAO. (2020) 'Food and Agriculture Organization of United Nations'; Available: <http://www.fao.org/statistics>.
- FAO. (2021 a) Global cereal markets tighten, as demand remains strong in 2020/21; record wheat production in 2021 could lead to higher stocks in 2021/22. <http://www.fao.org/worldfoodsituation/csdb/en/>
- FAO. (2021 b) Global map of salt-affected soils, GSAS map v1.0. <https://www.fao.org/global-soil-partnership/gasmap/en>
- Fawy, H.A. and Attia, M.F. (2013). Effect of some antioxidants and micronutrients foliar application on yield and quality of wheat grown in Siwa Oasis. Agric. Res., 38(4): 997-1007.
- Feghhenabi, F., Hadi, H., Khodaverdiloo, H., Van Genuchten, M.T. and Pessaraki, M. (2022).

**Proceeding Book of ISESER 2023**

- Improving wheat (*Triticum aestivum* L.) antioxidative defense mechanisms against salinity stress by exogenous application of potassium silicate. *Journal of Plant Nutrition*, 45(19): 2887-2905.
- Genedy, M.S. and Eryan, N.L. (2022). Evaluate of the bread wheat productivity for Egyptian recent genotypes under normal and salt-affected soils in Northern Delta Conditions, Egypt. *Journal of Plant Production*, 13(6): 265-271.
- Gerami, M., Mohammadian, A. and Akbarpour, V. (2019). The effect of putrescine and salicylic acid on physiological characteristics and antioxidant in *Stevia rebaudiana* B. under salinity stress. *J. Crop Breed.*, 11(29): 40-54.
- Hasan, A., Hafiz, H.R., Siddiqui, N., Khatun, M., Islam, R. and Mamun, A.A. (2015). Evaluation of wheat genotypes for salt tolerance based on some physiological traits. *Journal of Crop Science and Biotechnology*, 18: 333-340.
- Hassan, T.U. and Bano, A. (2016). Effects of putrescine foliar spray on nutrient accumulation, physiology, and yield of wheat. *Commun. Soil Sci. Plan.*, 47(8): 931-940.
- Hesse, P.R. (1971). *A Text book of Soil Chemical Analysis*. John Murray L<sup>td</sup>, London., 520.
- Ibrahim, M.A., Merwad, A.M., Elnaka, E.A., Burras, C.L. and Follett, L. (2016). Application of silicon ameliorated salinity stress and improved wheat yield. *Journal of Soil Science and Environmental Management*, 7(7): 81-91.
- Ibrahim, S.E., Elmoselhy, O.M. and El-Khamisy, R.R. (2022). Effect of mineral and organic nitrogen fertilization on yield productivity of some bread wheat cultivars and improving the soil sustainability. *Egypt. J. Plant Breed.*, 26(1):127-155
- Iqbal, M.S., Zahoor, M., Akbar, M., Ahmad, K.S., Hussain, S.A., Munir, S., Ali, M.A., Arshad, N., Masood, H., Zafar, S. and Ahmad, T. (2022). Alleviating the deleterious effects of salt stress on wheat (*Triticum aestivum* L.) By foliar application of gibberellic acid and salicylic acid. *Applied Ecology & Environmental Research*, 20(1): 119-134.
- Ishaq, H., Nawaz, M., Azeem, M., Mehwish, M. and Naseem, M.B.B. (2021). Ascorbic acid (Asa) improves salinity tolerance in wheat (*Triticum aestivum* L.) by modulating growth and physiological attributes. *Journal of Bioresource Management*, 7(4): 1-10.
- Jackson, M.L. (1967). "Soil Chemical Analysis". Prentice-Hall of India, New Delhi.
- Jebara, S., Jebara, M., Limam, F. and Aouani, M.E. (2005). Changes in ascorbate peroxidase, catalase, guaiacol peroxidase and superoxide dismutase activities in common bean (*Phaseolus vulgaris*) nodules under salt stress. *Journal of plant physiology*, 162(8): 929-936.
- Khedr, R., Aboukhadr, S., El-Hag, D., Elmohamady, E. and Abdelaal, K. (2023). Ameliorative effects of nano silica and some growth stimulants on water relations, biochemical and productivity of wheat under saline soil conditions. *Fresenius Environmental Bulletin*, 32(1): 375-384.
- Lee, D.H., Kim, Y.S. and Lee, C.B. (2001). The inductive responses of the antioxidant enzymes by salt stress in the rice (*Oryza sativa* L.). *Journal of Plant Physiology*, 158(6): 737-745.
- Lum, M.S., Hanafi, M.M., Rafii, Y.M. and Akmar, A.S.N. (2014). Effect of drought stress on growth, proline and antioxidant enzyme activities of upland rice. *JAPS: Journal of Animal & Plant Sciences*, 24(5): 1487-1493.
- Mohamed, H.I., Akladios, S.A. and El-Beltagi, H.S. (2018). Mitigation the harmful effect of salt stress on physiological, biochemical and anatomical traits by foliar spray with trehalose on wheat cultivars. *Fresenius Environ. Bull.*, 27(10): 7054-7065.
- Moran, R. (1982). Formulae for determination of chlorophyllous pigments extracted with N, N-dimethylformamide. *Plant Physiology*, 69(6): 1376-1381.
- MSTAT-C. (1990). *Microcomputer Program for Design Experiment and Analysis of Agronomic Research Experiments* Michigan State Univ.
- Noreen, S., Shaheen, A., Shah, K.H. and Ammara, U. (2019). Effects of aerial application of salicylic acid on growth, pigment concentration, ions uptake and mitigation of salinity stress



**Proceeding Book of ISESER 2023**

- in two varieties of wheat (*Triticum aestivum* L.). Pakistan Journal of Life & Social Sciences, 17(2): 78-85.
- Osman, E. and Nour Eldein, G. (2017). Response of three bread wheat to nitrogen fertilizer with or without ascorbic acid grown on a clay soil. Journal of Soil Sciences and Agricultural Engineering, 8(6): 267-274.
- Page, A.L. (1982). Methods of Soil Analysis, part 2: Chemical and Microbiological properties, (2<sup>nd</sup> Ed.) American Society at Agronomy, Inc. Soil. Sci Soc. Of Am. Inc., Madison. Wisconsin, USA.
- Richards, L.A. (1954). Diagnosis and improvement of saline and alkali soils (No. 60). Ed. US Government Printing Office.
- Siddiqui, M.H., Alamri, S.A., Al-Khaishany, Y.Y., Al-Qutami, M.A. and Ali, H.M. (2018). Ascorbic acid application improves salinity stress tolerance in wheat. Chiang Mai J. Sci., 45(3): 1296-1306.
- Snell, F.D. and Snell, C.T. (1967). Colorimetric Methods of Analysis. D. Van. Nostrand Company Inc., 551–552.
- Talaat, N.B. and Shawky, B.T. (2022). Synergistic effects of salicylic acid and melatonin on modulating ion homeostasis in salt-stressed wheat (*Triticum aestivum* L.) plants by enhancing root H<sup>+</sup>-pump activity. Plants, 11(3): 1-17.
- Vomocil, J.A. (1957). Measurement of soil bulk density and penetrability: A review of methods. Advances in Agronomy, 9: 159-175.
- Zheng, Y., Xu, X., Li, Z., Yang, X., Zhang, C., Li, F. and Jiang, G. (2009). Differential responses of grain yield and quality to salinity between contrasting winter wheat cultivars. Seed Sci Biotechnol., 3(2): 40-43.
- Zhong, M., Yuan, Y., Shu, S., Sun, J., Guo, S., Yuan, R. and Tang, Y. (2016). Effects of exogenous putrescine on glycolysis and Krebs cycle metabolism in cucumber leaves subjected to salt stress. J. Plant Growth Regul., 79(3): 319-330.

**O 43. PROTECTIVE EFFICACY OF AN INACTIVATED VACCINE AGAINST RABBIT HEMORRHAGIC DISEASE VIRUS 2 PREPARED FROM A LOCAL ISOLATE IN EGYPT**

Ola Y. Abido<sup>1\*</sup>

<sup>1</sup>*Central Laboratory for Evaluation of Veterinary Biologics, Agriculture Research Center, Cairo  
11381, Egypt*

E-mail: *ola.abido@yahoo.com*

**ABSTRACT:** Rabbit hemorrhagic disease is a contagious viral disease of rabbits controlled by vaccination. The present study was aimed to diagnose rabbit hemorrhagic disease from 11 infected farms from Qalubia governorate during 2019 and to prepare homologous vaccine against rabbit hemorrhagic disease virus 2. For this purpose, 11 liver samples were collected from suspected cases and subjected to detection and identification of circulating rabbit hemorrhagic disease virus. Ten samples were confirmed to be rabbit hemorrhagic disease virus using hemagglutination test, animal inoculation and reverse transcriptase polymerase chain reaction. Sequencing and phylogenetic analysis of two isolates (R5&R6) revealed the presence of rabbit hemorrhagic disease virus 2 (A/Qalubia/2019 and B/Qalubia/2019) under accession number MT07629 and MT067630 respectively. The inactivated rabbit hemorrhagic disease virus vaccines were prepared using Montanide ISA 206 oil or aluminum hydroxide gel adjuvants. Prepared vaccines were inoculated subcutaneously in susceptible rabbits and submitted to sterility, safety and potency tests. Obtained results showed that mean hemagglutination inhibition titer for aluminum hydroxide gel vaccine was 6,7,7,8,9 and 9.1 log<sub>2</sub> while, Montanide vaccine reached to 6,7,8,7,9,2 and 9.5 log<sub>2</sub> at 1st, 2nd, 3rd, and 4th weeks post vaccination, respectively. Immunized rabbits with Montanide vaccine showed better protection reach to 70%, 90%, 100% and 100% when compared to aluminum hydroxide gel vaccine 60%, 70%, 90% and 90% at 1st, 2nd, 3rd and 4th weeks post vaccination respectively. It was concluded that newly emerged rabbit hemorrhagic disease virus 2 was isolated from suspected cases. The two prepared vaccines were sterile, safe and potent. The oily adjuvanted rabbit hemorrhagic disease virus 2 vaccine stimulated an earlier and higher humoral immune response than the aluminum hydroxide gel adjuvanted vaccine. This humoral immune response achieved significant level of protection.

*Keywords: Rabbit Hemorrhagic Disease Virus; Humoral Immune Response; Vaccination; Serology; Polymerase Chain Reaction; Lethal Dose50.*

**O 44. APPLICATION OF MULTI-CRITERIA DECISION-MAKING METHODS IN  
SUSTAINABLE WATER RESOURCES MANAGEMENT: KONYA CASE**

Şule Eryürük<sup>1</sup>, Kağan Eryürük<sup>2\*</sup>

<sup>1</sup>*Department of Industrial Engineering, Faculty of Engineering and Natural Sciences, K.T.O. Karatay University, Konya, 42020, Türkiye*

<sup>2</sup>*Department of Civil Engineering, Faculty of Engineering, Necmettin Erbakan University, Konya, 42080, Türkiye*

E-mail: <sup>1</sup>*sule.eryuruk@karatay.edu.tr*, <sup>2</sup>*kaganeryuruk@gmail.com*

**ABSTRACT:** The water problem in the world has become an important issue for all countries. The decreasing amount of water we can leave to future generations has led many researchers around the world to take precautions and conduct studies before this situation becomes irreversible. Our country was a country that did not experience water shortage in the past years, but due to the increase in population and unconscious water use over the years, it is now among the countries suffering from water scarcity. This study aims to predict different scenarios that may arise in the future by determining the effects of water consumption and the status of existing resources after conducting research on the use of water resources of Konya Province. Another goal of this study is offering suggestions for sustainable management of Konya's water resources by using multi-criteria decision-making method or methods.

*Keywords: Decision-Making Methods, Water Management, Sustainability, Water Policy, Konya*

## **1. INTRODUCTION**

Water scarcity is a growing global issue that is caused by factors including population growth, climate change, and unsuccessful water management practices (UN-Water, 2021). Access to safe and dependable water sources is critical to the sustainability of public health, agriculture, industry, and ecosystems (WHO, 2019). Water loss is one of the main issues to access clean water. The magnitude of losses can be influenced by critical factors such as network connectivity, network age, and the size and configuration of the water distribution system (Ociepa et al, 2019). This phenomenon, known as Non-Revenue Water (NRW), poses a significant challenge to the sustainability of water resources and necessitates comprehensive management strategies. NRW includes both financial losses brought on by inaccurate metering and unaccounted-for usage, as well as physical losses brought on by leaking pipes, infrastructure breakdowns, and unauthorized water use (Farley and Trow, 2005). NRW poses threats to water quality, system resilience, and the equitable distribution of water services, in addition to the financial effects of lost income and the environmental effects of resource waste (Mollinga, 2010). The Analytic Hierarchy Process (AHP) is a potential tool for prioritizing and optimizing water loss management strategies while tackling NRW. By using the AHP, managers of water utilities and decision-makers can systematically evaluate the essential components of their water distribution systems, give each component a relative weight based on its significance, and rank mitigation strategies in order of relevance. By lowering water waste, energy use, and environmental consequences, such a strategy not only improves resource allocation efficiency but also helps achieve sustainability and resilience goals. Therefore, this study, which is based on an inquiry of the use of water resources in Konya Province, aims to estimate various future scenarios by evaluating the effects of water use and the state of the available resources now. Additionally, the study intends to make suggestions using AHP for the sustainable management of Konya's water resources.

## **2. MATERIAL AND METHOD**

### **2.1. Study area**

The city of Konya, is the largest province of Turkey with a surface area of 41,001 km<sup>2</sup>, is located in Turkey with coordinates ranging from approximately 36.70° to 39.25° N latitude and 31.25° to 34.43° E longitude and its elevation is approximately 1,006 meters. The centrum of Konya is consisted of three urban districts of Meram, Selçuklu and Karatay and the population is approximately 1,390,000. Konya is listed as a second-grade drought region in Turkey, and annual precipitation varies seasonally (Asaad

**Proceeding Book of ISESER 2023**

et al. 2022). Groundwater, which was supplied from many groundwater wells, was the main drinking water source of Konya (Nas and Berktaş, 2006).

**2.2. Analytic hierarchy process (AHP)**

Saaty created the analytic hierarchy process (AHP) multi-criteria decision-making technique in order to evaluate and select options within the chosen criterion group in 1990 (Eryürük et al. 2022). Utilizing AHP has as its goal the systematic organization of both tangible and intangible aspects as well as the provision of an organized, straightforward approach to problem-solving (Eryürük et al. 2022).

The AHP-based method intends to provide stakeholders with a support system for the selection of alternatives within the parameters of established criteria and sub-criteria, primarily for the purpose of evaluating quality (Eryürük et al. 2022). The next stage in creating a hierarchical table related to the decision-making problem is to decide how much weight to give to each criterion that has the same level of significance in relation to the others (Thanki et al. 2016). This stage uses Saaty's preference scale, which he graded from 1 to 9, for the portion of weighting in comparison with each other as shown in Table 1 (Saaty, 1987). Through applications in several sectors and theoretical comparisons with other scales, the effectiveness of this scale was determined (Uzun and Kazan, 2016).

**Table 2.** Pairwise comparison by means of Saaty's 1–9 scale

<b>Weight intensity</b>	<b>Definition</b>	<b>Explanation</b>
1	Equally important	Two activities contribute equally to the objective
3	Moderately important	Experience and judgment slightly favour one over another
5	Strongly important	Experience and judgment strongly favour one over another
7	Very strongly important	An activity is strongly favoured and its dominance is demonstrated in practice
9	Extremely important	The importance of one over another affirmed on the highest possible order
2, 4, 6, 8	Intermediate weights	Used to represent compromise between the priorities listed above

By assessing the consequences of water usage and the current state of the available resources, this study aims to anticipate potential future scenarios for the use of water resources in Konya Province using AHP. The suggested structure for managing water loss, which is shown in Figure 1, is organized hierarchically.

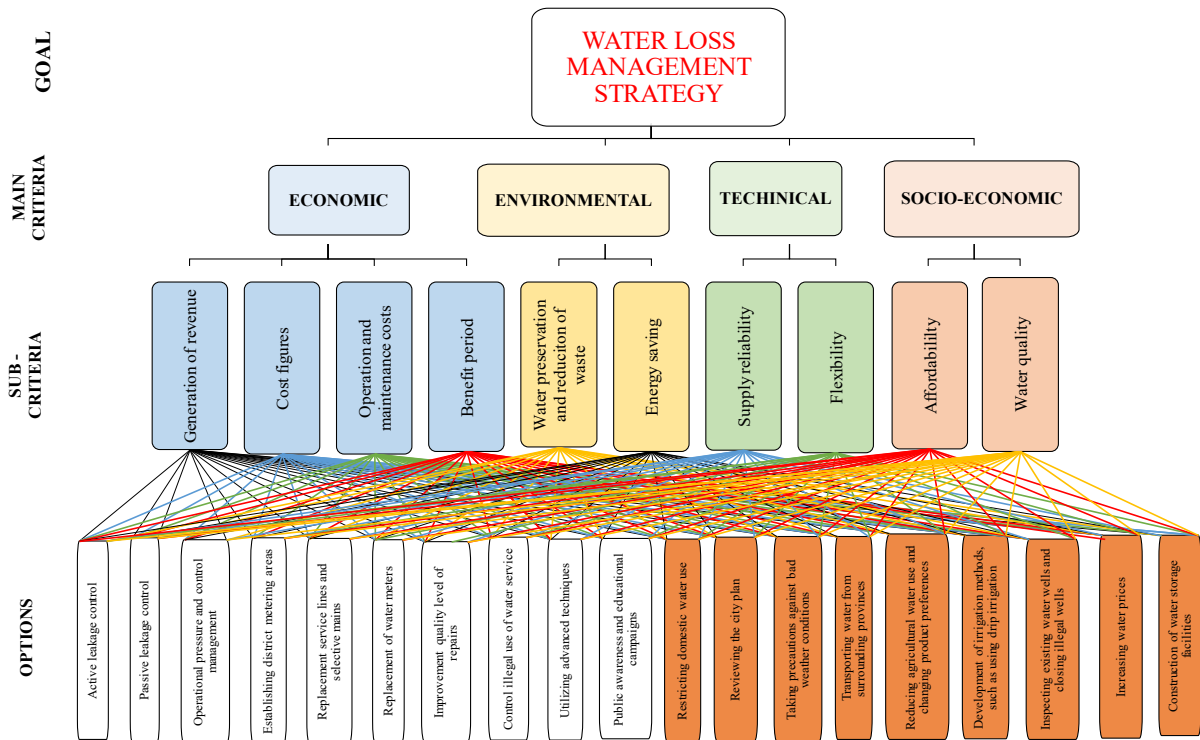

**Figure 1.** Proposed framework's hierarchical structure for managing water loss (derived from Zyoud et al. 2016)

The objective is the ultimate goal that stakeholders want to achieve, while the options are the alternative courses of action or solutions under consideration. In the case of this study, the problem definition is "Optimizing Sustainable Water Resources Management in the Konya Region."

Main criteria are the high-level categories or dimensions that contribute to achieve the objective. In water resources management study, main criteria could include economic criterion which could be able to evaluate the cost-effectiveness and economic sustainability of proposed solutions. Environment criterion explains the assessing the ecological consequences of water resource management strategies. Socio-economic criterion is considering the level of community support and acceptance. The technical criterion plays a crucial role in delineating the supply reliability and flexibility aspects.

Sub-criteria break down each main criterion into more specific factors that contribute to the overall assessment. Economics main criterion has four sub-criteria representing the economical aspect of the problem in detail. The main criterion as environment aspect consists of two sub-criteria that elaborate on the detailed aspects of the environmental issue. Technical main criterion includes two sub-criteria that provide detailed insights into the technical aspects of the problem. The socio-economic main criterion encompasses two sub-criteria that offer comprehensive insights into the socio-economical facets of the issue.

The objective and options refer to the decision-making context to see overall structure of the mentioned problem. The options could be different water management strategies or projects that can be implemented, such as watershed protection, water recycling, or the construction of new reservoirs.

In the AHP process, decision-makers assign numerical values called pairwise comparisons to evaluate the relative importance of criteria and sub-criteria. These comparisons help quantify the subjective judgments of decision-makers. Through a series of calculations, AHP provides a systematic way to derive priorities and make informed decisions based on a comprehensive analysis of multiple criteria and alternatives.

## Proceeding Book of ISESER 2023

### 3. RESEARCH FINDINGS

This research addresses the pressing issue of sustainable water management in the Konya region, where water scarcity and increasing demand pose significant challenges. Key problems include over-extraction from aquifers, inefficient irrigation practices, and the need for a comprehensive water management strategy.

Research findings indicate variations in water availability throughout the year, with implications for agricultural and domestic water needs. It is clear that sub-criteria might need to include seasonal variations, groundwater levels, and surface water availability. The efficiency of irrigation systems could be identified as a critical criterion, affecting agricultural productivity and water conservation. Some related options should be involved as the adoption of modern irrigation technologies and the assessment of irrigation infrastructure. The research reveals potential ecological consequences of water management practices, emphasizing the importance of maintaining a balance. The recheck might be necessary for sub-criteria to include the impact on local flora and fauna, wetland preservation, and biodiversity.

It is necessary to suggest that involving local communities in water management decisions is essential for long-term sustainability. As addition to that, one or more sub-criteria shall encompass community awareness, participation in conservation efforts, and education programs.

### 4. CONCLUSIONS AND DISCUSSION

According to this study, there is a necessity to identify decision makers to find out proper options to solve sustainable water resources management problem in Konya. Considering that point, at the beginning of the defining process of decision makers, government bodies at various levels should be identified as key decision makers which are responsible for policy formulation and regulation enforcement. Sub-decision makers may include municipal authorities, provincial water boards, and environmental agencies.

As an addition, local farmers and agricultural associations play a crucial role in decision-making, particularly regarding irrigation practices and water use in agriculture. For that decision maker level, it might be vital to include individual farmers, cooperatives, and agricultural extension services. Furthermore, non-governmental organizations dedicated to environmental conservation and sustainable development are found to be influential decision-makers in advocating for responsible water management practices, contributing valuable perspectives and initiatives to enhance the overall effectiveness of decision-making processes in this domain. Finally, academic and research institutions contribute to decision-making by providing scientific insights, data analysis, and innovative solutions for sustainable water management. Decision makers from that class could include water research centers, universities, and environmental research organizations.

These research findings lay the foundation for the subsequent development of an Analytical Hierarchy Process (AHP) diagram, where the identified criteria and decision makers are systematically evaluated and prioritized to guide sustainable water management decisions in Konya.

### REFERENCES

- Asaad, M. N., Eryürük, Ş., Eryürük, K., 2022, Forecasting of Streamflow and Comparison of Artificial Intelligence Methods: A Case Study for Meram Stream in Konya, Turkey. *Sustainability*, 14(10), 6319. <https://doi.org/10.3390/su14106319>.
- Eryürük, Ş., Kürüm Varolgüneş, F., and Varolgüneş, S., (2022), Assessment of stakeholder satisfaction as additive to improve building design quality: AHP-based approach, *Journal of Housing and the Built Environment*, 37, 505-528. <https://doi.org/10.1007/s10901-021-09855-8>.
- Farley, M., and Trow, S., 2005, Water Loss Control in Urban Water Distribution Systems: A Practitioners' Guide to Assessment, Monitoring and Control. IWA Publishing.
- Mollinga, P. P., 2010, Boundary Work and the Complexity of Natural Resources Management, *Crop Science*, 50(S1), 1-9.
- Nas, B. and Berktaş, A., 2006, Groundwater contamination by nitrates in the city of Konya, (Turkey): A GIS perspective, *Journal of Environmental Management*, 79, 30-37.
- Ociepa, E., Mrowiec, M., Deska, I., 2019, Analysis of Water Losses and Assessment of Initiatives Aimed at Their Reduction in Selected Water Supply Systems, *Water*, 11(5), 1037. <https://doi.org/10.3390/w11051037>.

**Proceeding Book of ISESER 2023**

- Saaty, R. W. (1987), The analytic hierarchy process—what it is and how it is used, *Mathematical modelling*, 9(3-5), 161-176.
- Thanki, S., Govindan, K., and Thakkar, J., (2016), An investigation on lean-green implementation practices in Indian SMEs using analytical hierarchy process (AHP) approach, *Journal of Cleaner Production*, 135, 284-298
- UN-Water, 2021, Water Scarcity. Retrieved from <http://www.unwater.org/water-facts/scarcity/>.
- Uzun, S., and Kazan, H., (2016), Çok kriterli karar verme yöntemlerinden AHP TOPSIS ve PROMETHEE karşılaştırılması: Gemi inşada ana makine seçimi uygulaması, *Journal of Transportation and Logistics*, 1(1), 99-113.
- World Health Organization, (2019), Progress on household drinking water, sanitation and hygiene 2000-2017: special focus on inequalities. World Health Organization.
- Zyoud, S. H., Shaheen, H., Samhan, S., Rabi, A., Al-Wadi, F., and Fuchs-Hanusch, D., (2016), Utilizing analytic hierarchy process (AHP) for decision making in water loss management of intermittent water supply systems, *Journal of Water, Sanitation and Hygiene for Development*, 6 (4): 534-546.

**O 45. LEACHATE BASED GLUE SYNTHESIS APPROACH**

Mahmut GÖKTAŞ<sup>1\*</sup>, Melayib BİLGİN<sup>2</sup>

<sup>1</sup>*Aksaray University Department of Engineering Management*

<sup>2</sup>*Aksaray University Department of Engineering Management/ department of Environmental Engineering*

E-mail: *mahmutgoktas.01@hotmail.com*

**ABSTRACT:** Today, converting leachate into a less environmentally harmful form or using it as raw material is considered an alternative approach for effective solid waste management. Developing world rules support environmentally friendly product synthesis. In this context, there is a transition from waste to green chemistry. Solutions with different concentrations were prepared to determine the distribution of the characteristic features of leachate in the garbage cycle in terms of environmental and beneficial product synthesis. An attempt was made to produce green phenolic resin by using phenol and formaldehyde with these solutions. The most important innovation of the experimental study is the preference of leachate to prepare formaldehyde solution. Phenol and formaldehyde solutions were synthesized under alkaline conditions. Thermogravimetric (TGA) measurements were carried out with FT-IR spectrum analysis to identify the specific properties of the product obtained after the synthesis stage. The bond strength of each resin sample was investigated under dry and wet conditions. In addition, the bonding strength of each resin sample was evaluated according to the EN 205 standard and compared with the values specified in the EN 12765 standard. The obtained FT-IR and TGA results provide data that organic compounds in the leachate may negatively affect the resin samples.

*Keywords: Phenol, Leachate, Green Phenolic Resin*



**O 46. PERSONNEL TRAINING IN IMPROVING THE PIPE PRODUCTION PROCESS**

Hüseyin KIZILTAN<sup>1\*</sup>, Melayib BILGIN<sup>2</sup>

<sup>1</sup>*Aksaray University Department of Engineering Management / Department of Environmental Engineering*

<sup>2</sup>*Aksaray University Department of Engineering Management / Department of Environmental Engineering*

E-mail: [kiziltanhuseyin@gmail.com](mailto:kiziltanhuseyin@gmail.com)

**ABSTRACT:** Today, plastic waste is shaped as a reflection of human imagination into reality and is gaining new dimensions in our lives every day. The increase in the use of plastic products in various industries has brought about the need for rapid production of quality products in these industries. These rapid developments in the plastic industry also include plastic technologies. Especially, great progress has been made in plastic pipe technology, which is not very new, and this technology has become the most used processing technology. One of the most important problems encountered regarding the injection method of plastic pipe is that the new product commissioning process is quite long and depends entirely on the knowledge, experience, and ability of the relevant personnel. In other words, this process is directly dependent on humans. The length of the new product commissioning process affects total production costs as a serious cost item due to machinery, and material costs. Many businesses that produce with the plastic injection method want to carry out the first production of the product on the machine using experienced personnel in order to shorten this process and minimize the costs incurred. As a result, since the source of error relies heavily on humans, providing training practices increases work performance and efficiency. According to the findings obtained from those who participated in the application and research conducted in this study, it was determined that productivity and job performance would be higher if a continuous developmental training program were applied to employees.

*Keywords: Pipe Production, Injection process, Personnel Training, Process*

## O 47. MICROGREEN FOOD CHOICE IN SUSTAINABILITY

Eda Güneş<sup>1\*</sup>, Büşra Betül Arıoğlu<sup>1</sup>

<sup>1</sup>Department of Gastronomy and Culinary Arts, Faculty of Tourism, Necmettin Erbakan University, Konya, Turkey.

E-mail: egunes@konya.edu.tr

**ABSTRACT:** Global climate change has affected not only our country but also the whole world. Due to global problems, access to natural agricultural products is decreasing in changing agricultural lands and the environment. In terms of sustainable culinary practices, it is possible to produce microgreens from local seeds through kitchen gardening. The main purpose of the study is to reveal the nutritional preferences of individuals as a behavioural model (using a model organism) in the consumption of microgreens produced using commercial seeds from sustainable culinary practices. In this context, micro sprouts were obtained from commercial cress seeds and added to the *Drosophila melanogaster* diet at a rate of 0-15%, and food preference was determined by the two way chose test.

*Keywords: Sustainable Agriculture, Sustainable Cuisine, Micro Green, Model Living*

### 1. INTRODUCTION

Global climate change has affected not only our country but also the whole world.

Due to global problems, access to natural agricultural products is decreasing in changing agricultural lands and the environment. Thus, negativities in terms of safe production, access, consumption and sustainability of food products are increasing day by day (Türkeş, 2020). Not only the change in food, but also access problems and contamination factors such as various diseases or drug residues related to safe food scare people. Thus, products that cannot be consumed and are of concern go to waste, causing waste generation in terms of sustainability. Unconscious consumption and stockpiling as a result of purchasing more than necessary due to the thought that the food will not be accessible, causes waste. Thus, food waste continues to increase its severity day by day. Although waste is seen in every field, it is known that its size is especially greater in the food and beverage sector.

Bread and greens are among the most wasted foods in the kitchen. In terms of sustainability, it is thought that greens can be offered to consumers through kitchen gardening when necessary. In terms of sustainable culinary practices, it is possible to produce microgreens from local seeds through kitchen gardening. The main purpose of the study is to reveal the nutritional preferences of individuals as a behavioural model (using a model organism) in the consumption of microgreens produced using commercial seeds from sustainable culinary practices. In this context, micro sprouts were obtained from commercial cress seeds and added to the *Drosophila melanogaster* diet at a rate of 0-15%, and food preference was determined by the two way chose test. Because our nutrition changes depending on environmental factors and affects our food preferences as well as our access to food.

The most preferred micro sprouts in the kitchen are: Amaranth, broccoli, peas, yarrow, radish, basil, celery, mustard, coriander, clover, basil, arugula, garlic, watercress, cress (Örnek, 2021). Cress (*Lepidium sativum*), on the other hand, accelerates fat burning in the body, facilitates digestion, is a diuretic, has appetizing properties, and is beneficial for liver and gallbladder diseases (Aydın, 2011). Although it is so useful, cress is also used as a pesticide and herbicide (Özcan and Tongur, 2019). For this reason, its use both as a nutritional model and as a pesticide was interpreted in the study. Based on these opinions, commercial microgreen cress was added to the insect diet in different dose, and food preference were evaluated. Cress is also used as a pesticide and herbicide. Therefore, it was used as a nutritional model in this study and its use as a pesticide was also investigated.

### 2. MATERIALS AND METHODS

The seeds were kept in water for a day in a dark environment, then the water was drained and they were planted in containers containing beeswax and hemp fiber. The sprouts, which were provided with constant air flow, were placed in the dark until the first leaves emerged, and when they started to turn

### Proceeding Book of ISESER 2023

micro green, they were placed in the sun. They were watered daily until microgreens emerged. It was harvested by cutting it from the top when it was approximately 10 cm. The harvested length is approximately 6-7 cm.

*D. melanogaster* (W<sup>1118</sup>) culture is fed in the University laboratory with a standard culture medium (SM) at incubator (25 ± 2°C and 60–70% humidity for 12/12 dark/light photo periods, Güneş and Danacıoğlu, 2018). Culture foods are renewed every 3-4 days. Commercially available Cress (*L. sativum*) was added to SM (0-15%). Flies, which were also used as nutritional and consumer behavior models to determine the pesticide effect, were transferred to the prepared foods as in the experimental setup. 5 female / 5 male individuals were taken into two opposite tubes with control and experimental groups in taste experiments and their feeding was monitored for 24 hours (Bayliak et al., 2017).

One-way "Analysis of Variance" (ANOVA) was used to determine the within-group variation, and "LSD Test" was used to determine the significance of the difference between averages.

### 3. RESULTS AND DISCUSSION

It was determined that the seeds became microsprouts (10 cm) in approximately 10-12 days. In this respect, it can be said that there is ease of production in the kitchen. Microsprout to be provided by soilless production; It is thought that it will be an environmentally friendly approach, as it saves space, costs and is produced without the use of drugs.

The insect feeds on cress at a maximum rate of 15%; It has been determined that upper dosages affect individuals (LC<sub>50</sub>) due to its use as an insecticide.

It has been determined that males and females have similar preferences in cress consumption depending on nutrition. In the graph created, it was determined that at most 10 % of the micro sprouts obtained from commercial seeds were preferred compared to the controls. In fact, it was determined that females fed with 10 % commercial food laid an average of 60 eggs on the food surface, while 15 % laid 50 eggs, and 5 % and 1 % laid 10-12 eggs on the food surface. These results prove that micro sprouts obtained from commercial seeds are more liked and preferred by insects for feeding.

These results show that food/food or food and beverages depend on consumer preference, and although it may vary according to local, regional or commercial factors, the consumer's food preference may change, and this change will also be reflected in the ecology. Because in nutrition awareness, it is recommended to increase the consumption of antioxidants added to the diet and plants used in salads such as cress, which are known to benefit many diseases. Many factors such as prejudices in consumption (cleanliness, content, origin, etc.), cost, and the scarcity of manufacturing companies limit their use. However, it should not be forgotten that the effects of some products may vary from organism to organism, dose and content.

With the experimental modeling, it has been determined that micro sprouts are easy to produce, their source and amount of use are important and will affect consumer preference. The less waste that comes from a sustainable kitchen, the more sustainable it will be in terms of environment, cost and production. It is possible that the resulting cress waste will be used by living creatures in nature for more than 15% and will act as a pesticide.

#### Support

Financial support for this study was provided within the scope of university student projects (TÜBİTAK 2209 A).

#### REFERENCES

- Aydın, M. ,2011, Metallerle etkileştirilen tere bitkisinde (*Lepidium sativum*) bazı enzim aktivitelerinin incelenmesi ,(Doctoral dissertation, Sakarya Üniversitesi (Turkey)).
- Bayliak, M. M., Lylyk, M. P., Shmihel, H. V., Sorochynska, O. M., Manyukh, O. V., Pierzynowski, S. G., Lushchak, V. I., 2016, Dietary alpha-ketoglutarate increases cold tolerance in *Drosophila melanogaster* and enhances protein pool and antioxidant defense in sex-specific manner, *Journal of Thermal Biology*, 60, 1-11.
- Güneş, E., Danacıoğlu, D. A., 2018, The effect of olive (*Olea europaea* L.) phenolics and sugar on *Drosophila melanogaster*'s development, *Animal Biology*, 68(4), 367-385.

**Proceeding Book of ISESER 2023**

- Örnek, A., 2021, Yiyecek içecek sektöründe yenilebilir çiçekler ve mikro filizler, Gastronomi araştırmaları, Editör Oğan Y., Çizgi kitap evi, 103-109.
- Özcan, Z., Tongur, S., 2019, Pestisitlerin toksisitesinin lepidium sativum test moduyla çevre ve insan sağlığı açısından değerlendirilmesi, *Ulusal Çevre Bilimleri Araştırma Dergisi*, 2(4), 144-150.
- Türkeş, M., 2020, İklim değişikliğinin tarımsal üretim ve gıda güvenliğine etkileri: bilimsel bir değerlendirme, *Ege Coğrafya Dergisi*, 29, 1, 125-149.

**O 48. INTER-RELIGIOUS ADVOCACY IN THE PROMOTION OF ENVIRONMENTAL  
SCIENCE**

Emmanuel Orok Duke<sup>1\*</sup>

<sup>1</sup>*Department of Religious and Cultural Studies, University of Calabar, Calabar, Nigeria*

E-mail: *e\_duke2001@yahoo.com*

**ABSTRACT:** The reality of rapid climatic changes in global scale has made the contributions of environmental science to the future of our ‘common homeland’ very critical to the survival of human race. However, its contribution is not enough considering the alarming effects of climatic disasters. Hence, multidimensional approach to global environmental crises has been widely accepted among environmentalists as holistic strategy towards ‘saving’ the earth. Thus, the tasks of religions as regards controlling the degradation of the earth are taken be taken seriously. This work explores the hierocratic functions of religions in promoting veritable discoveries of environmental scientists to their adherents in view creating sustainable environment-friendly consciousness among them. Inter-religious advocacy in the promotion of environmental science is aimed at making the religions ‘speak’ with one voice with regard to climatic remedies that are in dire need today. The collaborative learning theory will be used as heuristic tool for highlighting how the inter-religious approach to global advocacy in favour the dissemination of progress made in environmental science can aid in the ‘healing’ of the environment. Descriptive research method will be applied in this work because the hierocratic resources related to the environment from selected sacred texts (Bible, Koran, Torah, Sanskrit) will be collated for global interreligious advocacy towards making the world more habitable.

*Keywords: Inter-Religious, Environmental Science, Collaboration, And Common Homeland*

**O 49. MODERN URBAN DEVELOPMENT IN CALABAR: REDUCING HOUSING DEVELOPMENT'S ECOLOGICAL FOOTPRINT**

Ibiang Obono Okoi<sup>1\*</sup>

<sup>1</sup>*Department of Religious and Cultural Studies, University of Calabar, Calabar, Nigeria*

E-mail: *mail.ibiangokoi@gmail.com*

**ABSTRACT:** The need to govern land utilisation and the exploitation of natural resources has given rise to the notion of sustainability, which in turn encompasses the ecological footprint, denoting the aggregate land area necessary to maintain an individual's requirements. This study investigates the potential ecological footprint reductions associated with urban expansion and housing construction in Calabar, a mid-sized city in Nigeria. Specifically, it compares the ecological footprint savings between compact home buildings and single detached units, taking into consideration the size of the lots. The research approach used first included exploratory investigations, mostly consisting of physical observations, carried out across the city of Calabar. These investigations aimed to identify the primary land use activities that contribute to the accelerated urban expansion in the region. Furthermore, the examination of housing ideas was conducted via the implementation of experimental initiatives aimed at showcasing housing building paradigms that provide greater ecological advantages for urban areas. The ultimate goal of these endeavours is to mitigate the ecological impact of cities by reducing their carbon footprints in the long term. The findings indicate that the present expansion of urban development may be decreased by over 150% by the substitution of the prevailing practice of separate one-unit dwellings with the consolidation of units within a single block. Additionally, the research demonstrates the potential for preserving strips of agricultural land amongst urban expansion for the sake of urban agriculture.

*Keywords: Ecological Footprint, Sustainability, Housing, Urban Development*

**O 50. IMPACT OF OUTSIDE FARES CUISINE ON TOURISM GROWTH IN CALABAR,  
NIGERIA**

Maxwell-Borjor Achuk Eba Enamhe<sup>1\*</sup>, Dorn Ckclaimz<sup>2</sup>

<sup>1</sup>*History and International Studies, University of Calabar, Cross River State, Nigeria.*

<sup>2</sup>*Department of Social Work, University of Calabar, Cross River State, Nigeria*

E-mail: [raremaxxy@yahoo.com](mailto:raremaxxy@yahoo.com), [dornckclaimzenamhe@unical.edu.ng](mailto:dornckclaimzenamhe@unical.edu.ng)

**ABSTRACT:** The literature on culinary craftsmanship in urban and rural areas of developing countries is expanding. Individuals who identify as cosmopolites, unmarried and childless individuals, those who feel trapped or deprived, and ethnic villagers frequently seek alternative means of income in addition to traditional paid employment in order to navigate metropolitan living. The study employed many methods, including field observation, recording, photography, and oral interviews, to investigate the culinary craft industry in Calabar Metropolis. These methods were used to gather data for the study. The findings indicated that the Ekorimin catchment area had the highest employment rate, accounting for 45 percent of the total. The Mobil MCC Road had a slightly lower employment rate of 35 percent, followed by the RCC Roundabout with 13 percent. The Unical Hotel Road recorded the lowest employment rate at 9 percent. The findings also indicated that the operators of the fares encounter difficulties arising from substantial taxes imposed by the state government. A suggestion has been made for the state government to implement inclusive planning in order to incorporate diverse culinary practices from outside the region. This is proposed as a strategy to enhance the tourism and hospitality sectors in the Metropolis.

*Keywords: Impact, Outside Fares, Culinary Craft, Tourism Development, Calabar Metropolis*

**O 51. AGRICULTURAL FUNCTIONS FOR THE REQUIREMENTS FOR THE  
DEVELOPMENT OF AGRICULTURAL COOPERATIVES IN THE AL GHARBIA  
GOVERNORATE**

Moemen ELSayd Naeem Elsharkawy<sup>1\*</sup>, Ahmed Mamdouh Abdel Jalil<sup>1</sup>; Mohsmed Ahmed Nawara<sup>1</sup>,  
Mohamed Mohamed Helmy Ghalab<sup>1</sup>

<sup>1</sup>*Agricultural Extension and Rural Development Research Institute, Agricultural Research Center,  
Egypt*

E-mail: *ahmed19482002@yahoo.com*

**ABSTRACT:** The Search for farmers requirements for the development of agricultural cooperatives by identifying the level of agricultural cooperative performance for their functions from their point of view and to identify the level of awareness of the requirements for the development of agricultural cooperatives and identifying the independent variables that most contribute to explaining the total variation occurring in the degree of their awareness of the requirements for developing agricultural cooperatives; As well as identifying obstacles to the development of agricultural cooperatives from the view of the respondents.

*Keywords: Agricultural Cooperatives in the AL Gharbia Governorate*

*The results have shown what follows:*

- 40.2 % of respondents believe the level of cooperative performance for its medium functions; and 33.7% believe that the collaborative performance level for its functions is low; and 26.1% believes the level of cooperative performance for its functions.*
- That 41.8% of respondents came to study the requirements for the developments of agricultural cooperatives; and 36.6% was an average student; and 21.6% came low.*
- Eight independent variables combined together explain 46.3% of the macro variation at the degree of reshortals for the requirements for the development of agricultural cooperatives; 11.2% are attributable to the variable number of agricultural information sources on agricultural cooperatives; and 10.9% for the duration of dealing with agricultural cooperatives; 7.5% of them for the degree of participation in village development activities; 6.4% of the degree of education; and 3.8% for the volume of achievement; and 2.9% for the degree of knowledge of the guidance of agricultural cooperatives; and 2.8% for the degree of direction towards change; and 0.8% for the degree of knowledge of agricultural cooperatives.*
- There are twenty disagreed with the development of agricultural cooperatives from the perspective of respondents; and the most important arrangement was estimated as follows: weak infrastructure for agricultural cooperatives (91.8%) and the lack of role for cooperatives in contractual agriculture to protect the button; and maintain their rights (84.6%); and use parts of agricultural cooperatives in non-agricultural activities (80.4%); the lack of service and guidance activities provided for agricultural cooperatives (73.2%); the state neglects for agricultural cooperatives and the absence of support (72.2%) and the lack of administrative competencies and limited capabilities of the majority of agricultural cooperation boards (71.6%).*



**O 52. THE CULTURAL, MORAL, AND RELIGIOUS DIMENSIONS OF ENVIRONMENTAL PROTECTION**

Charles B. Berebon<sup>1\*</sup>

<sup>1</sup>*Department of Philosophy, Rivers State University, Port Harcourt, Nigeria.*

E-mail: [charles.berebon@ust.edu.ng](mailto:charles.berebon@ust.edu.ng)

**ABSTRACT:** This study provides a comprehensive analysis of scholarly papers pertaining to cultural, ethical, and religious viewpoints towards the preservation of the environment. Undoubtedly, the adverse impacts of the present environmental catastrophe on individuals' well-being and economic sustenance are universally acknowledged. The inadequate management of the environment has led to the occurrence of severe climatic fluctuations that are now being seen globally. The current scenario has pushed several parties, including environmentalists and governments, to actively explore viable strategies for mitigating and conserving the environment, with a focus on ensuring its sustainability for both present and future generations. This study asserts the significance of culture, ethics, and religion in the implementation of environmental preservation measures, based on a comprehensive examination of relevant scholarly literature.

*Keywords: Environmental Ethics, Culture, Religion, Ethics*

**O 53. BEHAVIOR OF SILLE STONE AGAINST ACID RAIN**

Serife Yurdagül KUMCU<sup>1\*</sup>, Gizem BÖLÜK<sup>1</sup>, Yasin Ramazan EKER<sup>2</sup>

<sup>1</sup>*Necmettin Erbakan University, Civil Engineering Department, Turkey*

<sup>2</sup>*Necmettin Erbakan University, Basic Science Department Turkey*

E-mail: [syurdagulkumcu@erbakan.edu.tr](mailto:syurdagulkumcu@erbakan.edu.tr); [boluk823@gmail.com](mailto:boluk823@gmail.com); [yeker@erbakan.edu.tr](mailto:yeker@erbakan.edu.tr)

**ABSTRACT:** The structures in which human activities are carried out and we are in at any time are reacting with the increasing acid rain and acids caused by different reasons. Building materials lose their chemical and physical properties as a result of reactions with acids. Sille stone, which has quarries in the Sille district of our Konya province, is a building material that has been used since ancient times. The resistance of this building material, which is still preferred in housing construction in today's conditions, against acid rain, although it has been encountered in various historical artifacts carried from different cultures and civilizations until today, was discussed in this study. The pH value of rainwater varies between 5.6 and 6 and shows acidic properties. It has been observed that the pH value of acid rains fell below 5 and decreased to 3 in some places in the world. Sulfuric acid, nitric acid, carboxylic acid and their mixtures, which are frequently encountered in acid rain, were used in this study. 7x7x7 samples were taken from the stone quarries in Sille district. 1 molar concentration were prepared to examine the behaviour of Sille stone as a result of the reaction of these stones in seasonal acid rains. The samples were kept in natural and acidic environments by being varnished with stone varnish as they came out of the quarry. In this way, the protection of stone varnish against acid rains was also analysed.

*Keywords: Acid rain, Nitric acid, Sille stone, Citric acid, Sulfuric acid.*

## **1. INTRODUCTION**

Palta (2020) examined the effect of boric acid on self-compacting concrete. They produced the concrete themselves. 6 samples were obtained by adding a reference sample and 0.5%, 1.0%, 1.5%, 2.0%, 2.5% boric acid by weight to the concrete water, respectively. Diffusion Table, V-Funnel, L-Box, U-Box tests from Fresh Concrete Tests were performed on these 6 samples produced. Compressive strength and bending strength experiments were carried out to compare the changes in the mechanical properties of the obtained samples. Additionally, SEM and XRD analyzes were performed to observe structural characterization changes. When SEM images were examined, boric acid accelerated the formation of C-S-H gels by binding C-H to itself over time, and with the effect of this, an increase in compressive strength was achieved over time. Thus, with the addition of boric acid, a new C-S-H gel was formed and the structure was made more impermeable and durable. With the addition of 2.5% boric acid, the gaps and pores began to increase significantly. Micro crack formation was also observed. As a result of this situation, the increase in compressive strength decreased compared to the control sample. In the XRD analysis, when looking at the XRD peaks, especially after the 0.5% Boric acid additive rate, the dominant peak intensities seen at approximately 30° started to increase effectively. The low peak intensity of 0.5% Boric acid additive ratio can be associated with the decrease in particle size and pores. It can be said in the SEM image of the sample with 0.5% boric acid that the particles are smaller compared to other samples. SEM and XRD analysis results support the increase in compressive strength, especially in the concrete sample with 0.5% Boric acid added. When a general evaluation was made, it was seen that Self-Compacting Concrete could be produced by adding boric acid.

Reddy studied three different regions in the northeastern United States in 1988. The aim of this research is to examine the effects of dry and wet deposition states of acid on stone separately. As a result of the experiments and observations, it was revealed that the stagnation on the stone surface is proportional to the amount of precipitation. In other words, the amount of precipitation that falls on the stone will increase the dissolution on the stone surface proportionally. This research has shown that the result is proportional to the hydrogen ion arriving on the stone surface (Reddy, 1988).

Charola (1987) have studied limited the pollutants that cause acid rain to only sulfur oxides. He limited the stones he examined to quartz, which is a stable mineral form. As a result of his research, he attributed the deterioration of calcareous stone to two main reasons. The first is the chemical dissolution

## Proceeding Book of ISESER 2023

of calcite, and the second is the damage caused by the salts formed during dissolution crystallising again in the stone pores. The first case explains the deterioration in the surface details of buildings and monuments, and the second case explains the causes of structural damage to the stone.

In 2005, Tecer examined the effects of SO<sub>2</sub> and NO<sub>x</sub> resulting from environmental pollution on carbonate rocks. He examined the results of the effects of air pollutants on historical structures whose main component is CaCO<sub>3</sub>. Effects of Sulfur Dioxide, effects of Nitrogenides, Effects of Carbon Dioxide, effects of Acid Rain, effects of Particulate Matters on carbonate rocks is examined in the study.

Bravo (2005) had experiments to observe the dissolution that occurs when limestone is exposed to acid rain. As a result of the studies, it was determined that 85% of the precipitation in this region is acidic and the limestone building material in this region is dissolved by acid rain and as a result, it erodes over time and loses its shape and resistance.

## 2. MATERIALS AND METHODS

Air pollution, which has become one of today's important environmental problems with the rapid increase in industrialization brought about by advanced technology, causes acid rain. The aim of this thesis is to examine the effect of acid rain on the Sille stone, a geological heritage reserve in the Sille district of Konya. The changes in physical and chemical properties of Sille stone were examined. Additionally, it was aimed to reduce this effect and the Sille stones were covered with stone varnish. The change in strength and chemistry of Sille stones coated with stone varnish compared to unvarnished Sille stones was compared.

In this study, nitric acid (HNO<sub>3</sub>) prepared as 1 molar for Sille stone for 6 months, were applied to Sille stones in water, nitric acid, source and in the atmosphere environment, coated with stone varnish and uncoated. It was kept for 6 months. Mechanical and chemical changes of Sille stones during seasonal transitions were analyzed over a 6-month period.

### 2.1. Used materials

The main material of this study is Sille stone which is stated that the required sample size for the pressure test on TS1926 natural stones should be 7x7x7 cm<sup>3</sup>. For this reason, in this study, which will last 6 months, the size of a sample of Sille stone will be a cube of 7x7x7 cm<sup>3</sup>. Compressive strength test is performed on at least 5 test samples for each environment (TS 1926). Additionally, 1 test sample is required for chemical experiments. In this case, 5+1 unvarnished and 5+1 varnished test samples are required for each environment.

	varnished	unvarnished
Referans	5+1	5+1
Nitric Acid	5+1	5+1
Atmosphere	5+1	5+1
Water	5+1	5+1
Total	48	

## 3. DISCUSSION and RESULTS

### 3.1. Pressure Test

Compressive strength is the maximum stress that occurs in concrete under the effect of axial pressure load and the resistance it shows to avoid breaking. The reasons why the most commonly used strength is compressive strength; the test applied to determine compressive strength is simpler than the tests applied to determine other types of strength. The compressive strength value has an important role in building designs. If the compressive strength is known, one can have an idea about the other strength values of the samples and make comments.

The pressure test was prepared depending on TS 1926 conditions and its procedure. Sille stone was prepared as cube samples with dimensions of 7x7x7 cm<sup>3</sup>. Before placing the sample on the compression device with adjusted loading speed, it was checked that the surface on which the sample would be placed was clean and smooth. The sample was carefully placed on the testing device in the center of the loading bed so that the load would act exactly in the middle and axially. After the placement process was completed, loading was started and the maximum force withstood by the sample was

**Proceeding Book of ISESER 2023**

measured from the device. The compression test was carried out with the compression device in the civil engineering laboratory of Necmettin Erbakan University.

Comments were made on the behavior of the samples under load with the pressure test, which is a mechanical experiment. As a result of the compression test performed without waiting for the Sille stone when it was first removed from the its source originally, the strength was measured as 30.91 MPa. The compression test result of the Sille stone samples, which were varnished and kept for the varnish to dry, was measured as 25.61 MPa as seen in Table 1.

**Table 1.** Compressive strength of Sille stone, taken from the its source, with and without varnish.

	Sample No	7*7*7 Cubic (KN)	Compressive strength (MPA)	Average (MPA)
Unvarnished	1	133,95	27,34	30,91
	2	177,44	36,21	
	3	128,57	26,24	
	4	162,26	33,11	
	5	154,98	31,63	
Varnished	1V	84,93	17,33	25,61
	2V	154,36	31,50	
	3V	109,13	22,27	
	4V	135,54	27,66	
	5V	143,44	29,27	

As can be seen from the Figure 1, applying varnish prevented oxygen from passing through. For this reason, the strength in varnished samples was lower than in unvarnished samples. As can be seen from the figure, it was observed that the compressive strength is increasing in all environments compared to the strength when they first came out of the quarry. This is a sign that the strength of quarried samples increases when exposed to oxygen. Applying varnish prevented oxygen from passing through. For this reason, the strength in varnished samples was lower than in unvarnished samples.

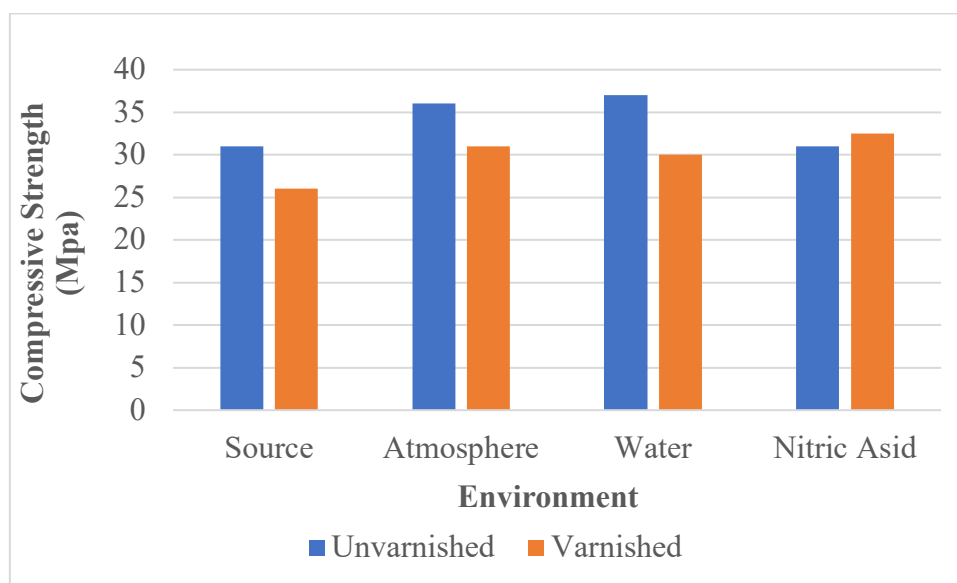

**Figure 1.** Compressive Strength of samples

Over time, both physical and chemical transformations occur in Sille stone. The physical transformation of the stone occurs when the quarried Sille stone turns into a lower energy state as the

## **Proceeding Book of ISESER 2023**

pressure on it decreases. Chemical transformation of the stone is the changes in compressive strength as a result of chemical reactions in Sille stone samples kept in different environments.

### **4. RESULTS**

- The transformation began to negatively affect the sample by destroying it, and a decrease in compressive strength occurred in the 6th month.
- It has been observed that the improvement in mechanical properties is slower in Sille stone samples varnished and kept in atmosphere, water and acid environments. However, it has been determined that Sille stone samples behave more stable over time.
- It is thought that not varnishing the stones used in houses and buildings intended to be built using Sille stone at the beginning, but varnishing them after a certain period of time, will be effective in increasing the compressive strength. Determining this period clearly experimentally may be the subject of future studies.
- In order to examine the transformations in the chemical and physical properties of Sille stone in more detail, more detailed findings can be detected and evaluated by selecting a single aging environment and performing strength tests over a longer period of time and at shorter intervals.

### **REFERENCES**

- Palta, E., Çağlar H. And Çağlar A., 2020, The Effect of Boric Acid on Mechanical Properties and Structural Characterization of Self-Compacting Concrete, Turkish Journal of Nature and Science, 9 (Special Issue), 160-166.
- Charola, A.E., 1987, Acid Rain Effects on Stone Monu-ments. Jornal of Chemical Education 64 (5), 436-437.
- Tecer, L. K., 2005. Hava kirleticilerin karbonatlı yapı malzemeleri üzerine etkileri. Pamukkale Üniversitesi Mühendislik Bilimleri Dergisi, 11, 231-237.
- Reddy, M. M. 1988, Acid-Rain Damage To Carbonate Stone: A Preliminary Quantitative Assessment Based on the Aqueous Geochemistry of Rainfall Runoff, Department of the Interior Donald Paul Hodel, Secretary U.S. Geological Survey, U.S. Geological Survey Water-Resources Investigations Report 87-4016.

**O 54. THE EFFECT OF LAYOUT OF ENERGY DISSIPATORS ON ENERGY DISSIPATE**

Serife Yurdagül KUMCU<sup>1\*</sup>, Kamil ISPIR<sup>2</sup>

<sup>1</sup>*Necmettin Erbakan University, Civil Engineering Department, Konya, Turkey*

<sup>2</sup>*State Hydraulic Works, 4. Regional Directorate, Konya, Turkey*

E-mail: [syurdagulkumcu@erbakan.edu.tr](mailto:syurdagulkumcu@erbakan.edu.tr); [kamilispir@dsi.gov.tr](mailto:kamilispir@dsi.gov.tr)

**ABSTRACT:** Energy dissipater in the stilling basin is a structure designed to protect downstream of the spillway from erosion and scour by reducing flow energy in the energy dissipation pool. Energy dissipation pool is an important element of hydraulic structures as a transition between the high-velocity flow and the sensitive tail water. The aim of this study is to investigate the energy dissipation ratios of baffle blocks which constructed in Type III stilling basin by using physical and numerical modeling methods. Energy dissipation ratio of the baffle blocks were determined in 3 different layouts as single row, two rows and two rows without end sill are tested. In addition, these experimental studies were tested by numerical study.

*Keywords: Open channel hydraulics, Spillway structures, Stilling basins, Energy dissipation block, Energy dissipaters, FLOW-3D, Hydraulic Jump.*

## 1. INTRODUCTION

Spillways are the hydraulic structures that transfer the excessive water safely from reservoir to downstream side without damaging the dam body. A spillway structure generally consists of the approach channel, spillway, aerators and the energy dissipation structure. Approach flow discharging from top of the dam body with high energy can damage the structures on the downstream side of the spillway and by scouring. Energy dissipating structures, reduce the energy of the flow which is coming over the dam body and allow it to pass to the downstream side with lower energy. The basic principle of energy-dissipating structures is to ensure that the hydraulic jump, that formed when flow regime changes from supercritical to subcritical, occurs in the stilling basins (Hager, 1992)

Stilling basins types were first described in by Bradley and Peterka in 1957 and a series of experiments on chute blocks, baffle blocks and end sill were carried out and stilling basins types were classified according to Froude number and flow velocity. Energetic blocks are placed in the scattering pool to allow hydraulic splashing to occur and to increase turbulence. Baffle blocks are placed in the basin to allow hydraulic jump to occur and to increase turbulence, by this way needed basin length is shortening to break energy of flow. Baffle blocks can be used in a single row or in more than one row. It has been suggested by the Peterka (1984) that baffle blocks in the second and subsequent rows should be placed in a staggered manner, the first block should be placed half the width of the block from the wall, and the width of the blocks in the same row and the distance between the blocks should be equal. Some researchers have tried to increase the efficiency by changing baffle and chute block geometries in the stilling basin structure (Pagliara and Palermo, 2012; Bestawy, 2013). Cook (2002) created a numerical model of the spillway and stilling basin constructed within the scope of the Dalles project using Flow-3D and compared the results obtained from the numerical model and the physical model. Amorim (2015) compared the results obtained from numerical model of the stilling basin of the Porto Colombia Hydroelectric power plant with 1/100 scale physical model of the power plant. Nigam et al. (2016) did an overview and worked on hydraulic jump type stilling basins. They dealt with the hydrodynamic design aspect of jump type energy dissipaters by experimentally and analytically along with comparison of various energy dissipaters. Based on the estimating the uplift and hydrodynamic forces on energy dissipaters, although jump type energy dissipaters with only one end sill is sufficient for higher velocities, it was not recommended to use it for head above 100 meter. Dermawan et al. (2021) was carried out the physical model study by experimentally by bottom lowering of horizontal and USBR II stilling basin. It was expected to represent flow behavior in the overflow system regarding flow conditions and energy dissipation. After experiments, the amount of flow energy that occurs at each control point is calculated. USBR II is found that, In which has baffle blocs at the toe and end sill, the flow becomes more turbulent with compared to the flat stilling basin that does not have baffle blocks.

Proceeding Book of ISESER 2023

USBR II it was better than flat stilling basin while discharge is increasing with a higher difference in overflow height.

Flow conditions on overflow systems can result in construction failure, mainly due to the high flow energy. Since the dams require a unique design (site-specific) in topographic conditions, there may be situations where the energy dissipation pool is not sufficient. In such cases, USBR designs may not be enough and additionally energy dissipater blocks can be used to obtain higher energy loss (Kumcu and Kökpınar, 2019).

In this study, the physical hydraulic model test was carried out to increase energy dissipating ratios of various baffle blocks placed in various layouts on USBR III energy dissipating pools. So, the contribution of the baffle blocks in stilling basins located downstream of the ogee spillway to find out energy dissipation ratios which were investigated by physical and numerical modeling methods.

2. MATERIAL and METHOD

A hydraulic jump is a sudden rise in the water surface that occurs when the flow regime changes from the supercritical to the subcritical. During the hydraulic jump, a significant amount of energy is absorbed over a short distance. In Figure 1 the general view of the stilling basin and hydraulic jump formed in the pool are given.

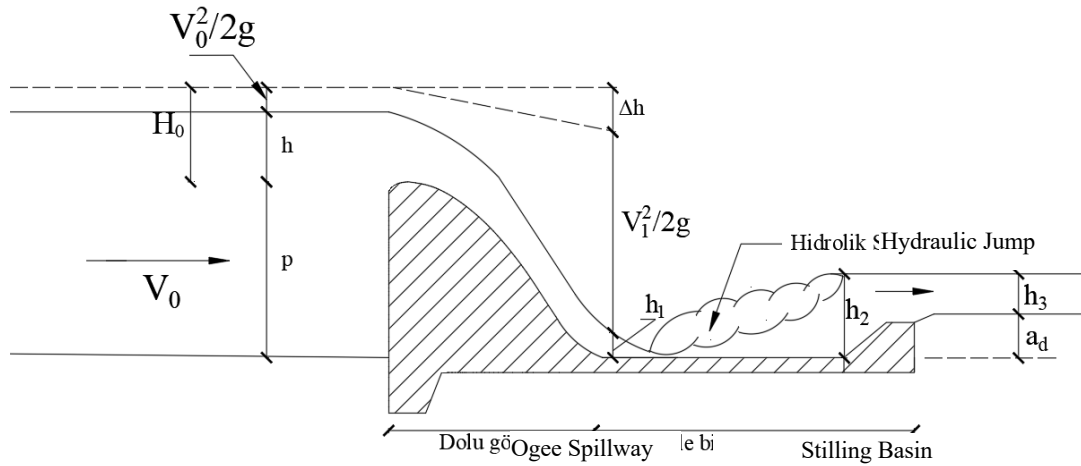

Figure 1. Hydraulic jump in the stilling basin

The definitions of the parameters described in Figure 1 are given below.

- $h_1$  = Flow depth before the hydraulic jump
- $h_2$  = Flow depth after the hydraulic jump
- $h_3$  = Flow depth at downstream
- $h$  = Flow head over the crest
- $p$  = Crest height
- $a_d$  = End sill height
- $V^2/2g$  = Velocity head
- $V_0$  = Approach flow velocity
- $V_1$  = Velocity of the flow before the jump
- $\Delta h$  = Head of the dissipated energy
- $H_0$  = Total water head over the crest

The relationship between  $h_1$  and  $h_2$  by using the momentum equations during the hydraulic jump is as follows.

$$\frac{h_2}{h_1} = \frac{\sqrt{1 + 8Fr^2} - 1}{2}$$

Hydraulic jumps are classified according to the Froude number as  $Fr = \frac{v}{\sqrt{g \times h_1}}$ . Depending on the Froude number, jump types are given in Figure 2.

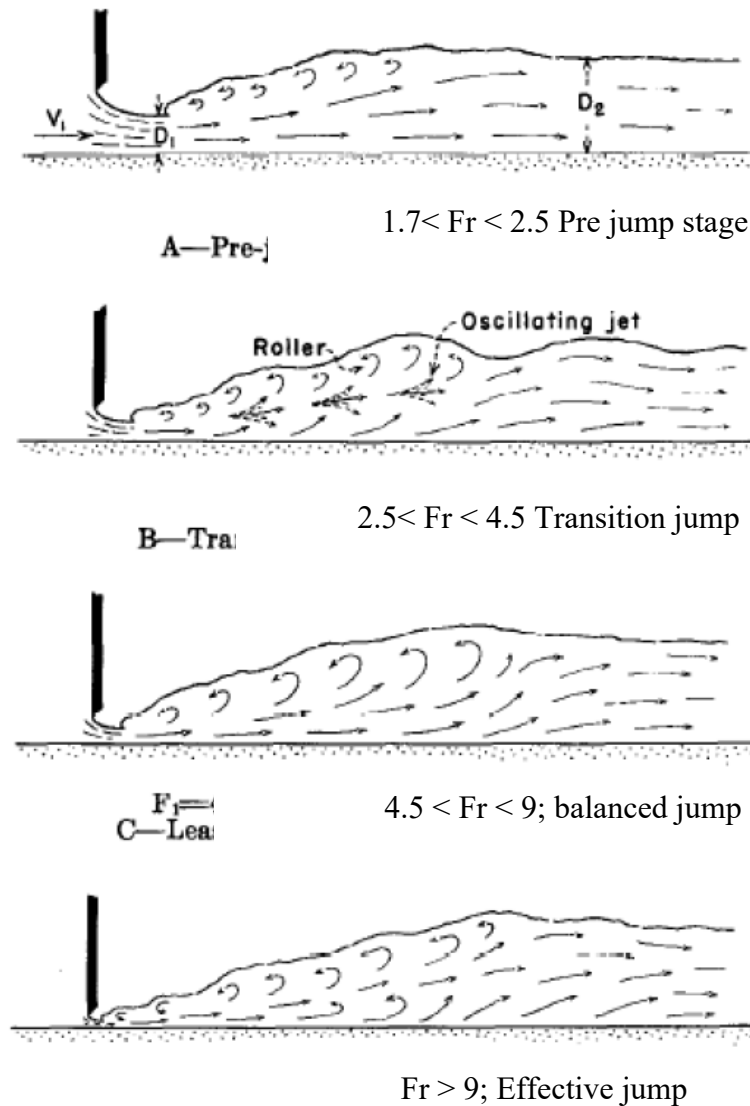

Figure 2. Hydraulic jump types depending on Froude number (Peterka, 1984).

### 2.1. Stilling basin

Flow depth ( $h_1$ ) and corresponding velocity ( $V_1$ ) and Froude number ( $Fr$ ) before the hydraulic jump were calculated, and the highest velocity and the Froude number were computed as 2.75 m/s and 8.83, respectively. Type III stilling basin is used when the Froude number is greater than 4.5 and the flow velocity is less than 18.3 m/s (60 ft/s). Thus, USBR type III stilling basin was chosen, which is suitable for the design in flow conditions where the calculated Froude number,  $Fr=8.33$  is greater than 4.5 and the maximum velocity  $V_1=2,75$  is less than 18.3 m/s (60 ft/s). Type III stilling basin is designed according to USBR and dimensioning of the basin, baffle and chute blocks are given in Figure . Limit values of the study are given in Table 1.

Table 1. Max and Min values used for designing USBR Type III basin

Min / Max	Q (l/s)	H (cm)	$h_1$ (cm)	Channel width, B (cm)	$V=Q/A$ (m/s)	$Fr = V/\sqrt{gh_1}$	$\frac{h_2}{h_1} = \frac{\sqrt{1 + 8Fr^2} - 1}{2}$
Min	1.10	1.52	0.26	30.00	1.41	8.83	3.12
Max	39.62	14.40	4.80	30.00	2.75	4.01	24.92



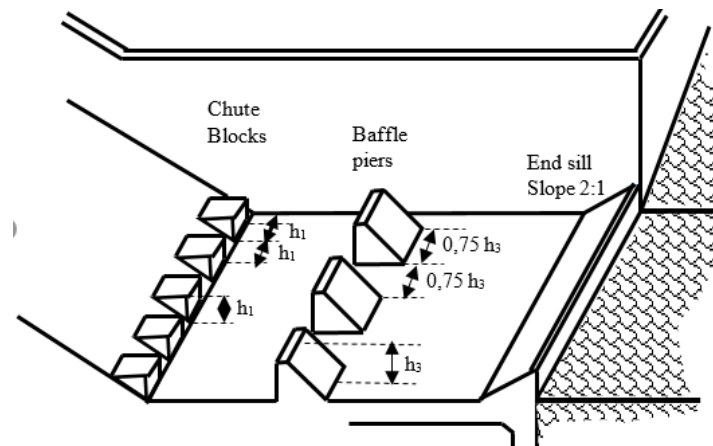

Figure 3. Type III stilling basin (Peterka, 1984)

## 2.2. Experimental setup

Experiments were carried out in a rectangular open channel with a length of 670 cm, a width of 30 cm and a depth of 50 cm. In the experimental setup, flow in the open channel is provided by two pumps, each of which has a power of 7.5 kW, connected in parallel to the system. The water flowing in the open channel system is supplied from two reservoirs. The pumps take the water from the reservoir-1 and convey it into reservoir-2. Then, the water reaches to the reservoir-2 passes through the laboratory flume and is poured back into the reservoir -1 (**Error! Reference source not found.**). The total discharge in the channel is equal to the sum of the flows supplied from both pumps. The flow discharge that the pumps will provide is adjusted by the frequency alternative on the panel to which the pumps are connected. The flow through the system is read by electromagnetic flowmeter placed between the pipes after the pumps. Flow depth was measured with a limnimeter with an accuracy of  $\pm 1$  mm placed in the open channel (**Error! Reference source not found.**). The open channel flume is made of 1.2 cm thick laminated glass-walled, which is obtained by combining two 0.6 cm thick tempered glass sheets with a plastic layer placed between them. In the experiments, ogee type profile and stilling basin made of plexiglas.

Experiments are conducted for 7 various discharge values (10, 15, 20, 25, 30, 35 and 39.62 l/s). Stilling basin elements were prepared in accordance with the methods recommended by the USBR and adhered to the open channel with the help of silicone. The flow depths were measured with the help of a limnimeter.

## 2.3. The Effect of the Shape of Energy Dissipater Blocks on Energy Dissipation

Experimental studies were carried out on physical models for investigating the energy absorption ratios of the energy dissipating blocks placed in the USBR Type III stilling basin. In the experiments, the data obtained by measuring the height after splashing and downstream water level at 7 different flow rates were compared, and the energy dissipating ratios were calculated. In the experiments, trapezoidal energy dissipater were used. The energy block types used were placed in the energy dissipating pool first in a single row, then 2 rows and then 2 rows without threshold, and the flow conditions were investigated. Plan and profile views of the energy dissipating block types are given in **Error! Reference source not found.**

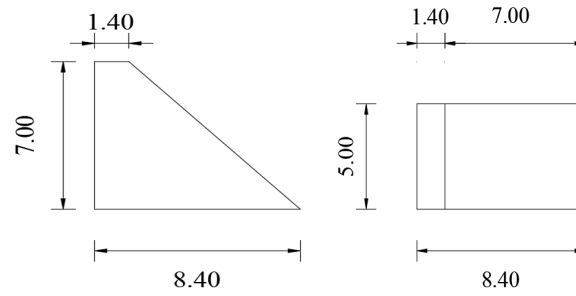
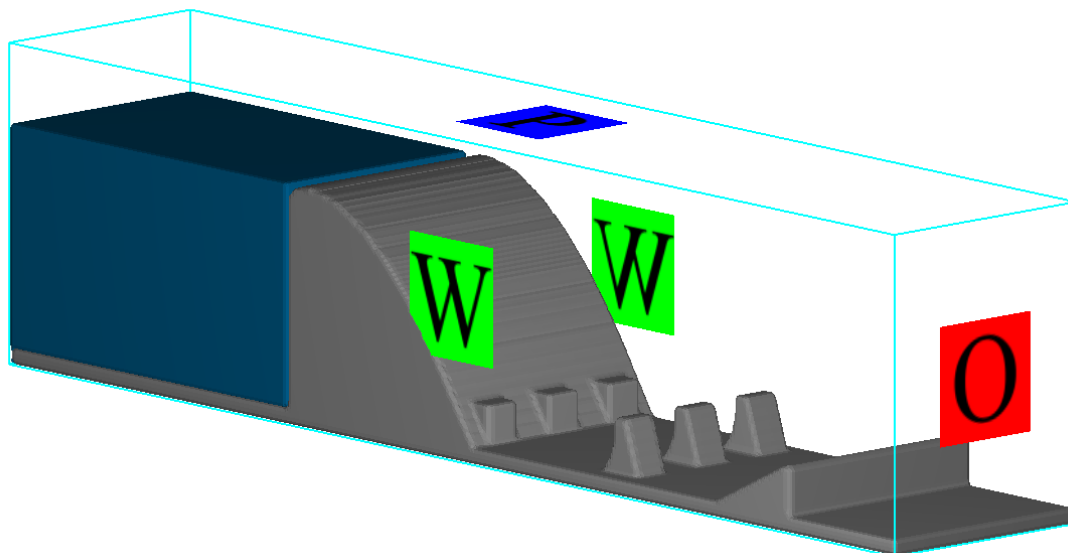

**Figure 4.** Block types used in the experiments; a) Longitudinal cross-section and b) Top view of the dissipating block types

## 2.4. Numerical Modelling

FLOW-3D is a computational fluid dynamics solver, a commercial mathematical computation program that can solve multiple fluid mixtures using the finite difference method. A single fluid-free surface flow solution was used in the analyses. For the VOF (Volume of fluid) method, it is provided to define the fill or void ratio of each mesh cell and to perform pre-debugging by using pre-process. Mesh cells of 5 mm size were used in the analyses, and the mesh block contains a total of 1,536.000 cells. The part where water enters the system (-X side) is defined as the pressure (static water level). Depending on the desired weir load on the weir, the height of this static water level was adjusted and water was allowed to enter at the desired height. The side surfaces and the bottom of the pool were chosen as walls, the downstream part as outflow and the upper part as pressure to represent the atmospheric pressure. To obtain the desired analysis results, Fluid Fraction (filling ratio) and hydraulic data options are marked in the "output" section. The solid model and layer conditions used in the analysis are shown in Figure 5.

The velocity and Froude number values calculated by numerical model are shown in **Error! Reference source not found.** According to the numerical model, the maximum Froude number was calculated as 7.25 and the maximum velocity was calculated as 3.06. These values are consistent with the values chosen during the selection and design of the energy dissipating structure and show the accuracy of the numerical model.



**Figure 5.** Solid model used in the CFD simulations of single row trapezoidal energy dissipaters

Proceeding Book of ISESER 2023

3. RESULTS and DISCUSSION

3.1. Physical Model

During this experimental study on the open channel, the energy dissipation ratios of baffle blocks having different geometric shapes were investigated with the help of the hydraulic jump created in the flow. The measured depths and velocities of the flow before and after the hydraulic jump formation were investigated, and the energy dissipation ratios were found by computing the total heads of the flow. To determine the amount of energy dissipation and to find the most effective plan shape of baffle blocks were designed as; single row, double row and double rows and compared according to their non-threshold arrangement. The graphs is given in Figure .

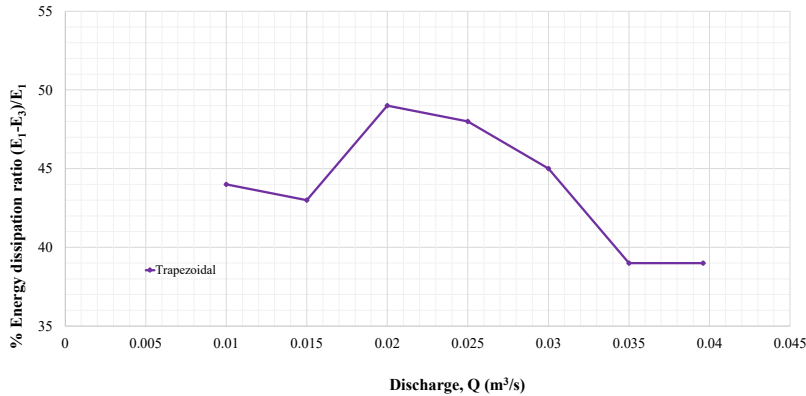

Figure 6. Energy dissipating ratios of the single row energy dissipaters

When the energy dissipation ratios of the single row energy dissipater blocks are examined in Figure 7, it is seen that the highest absorption rate is obtained at 20 l/s, which corresponds to almost 50% of the total head of the flow.

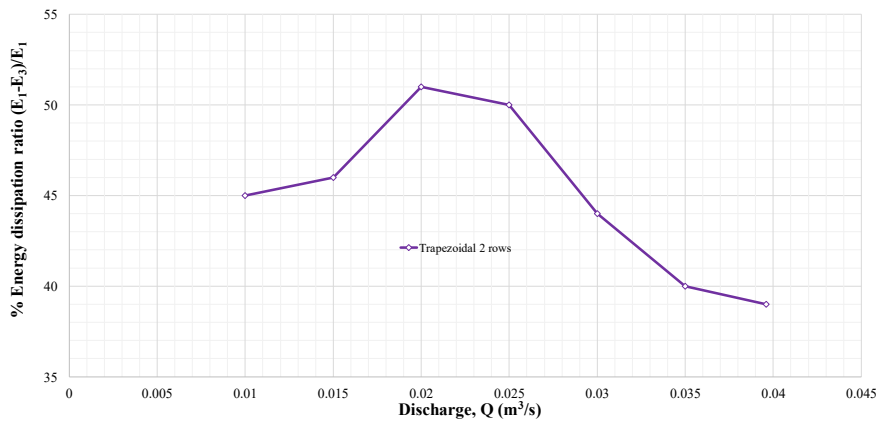
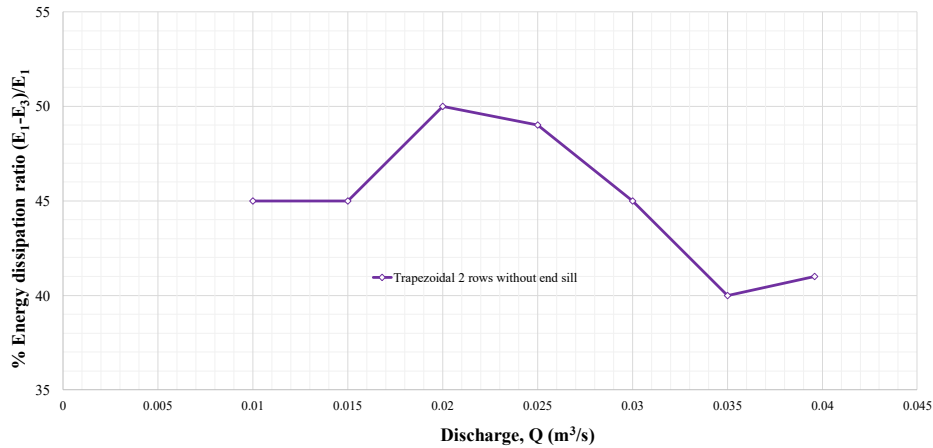

Figure 7. Energy dissipating ratios of two rows energy dissipaters

When the energy damping ratios of the two-row energy breaker blocks are examined in Figure 8, it is seen that the highest damping rate decreased by 51% with 20 l/s, which corresponds to almost 50% of the design flow. In the design flow, it was observed that the highest energy breaking rate belonged to the T-section energy breaker block plan and reached 39%.



**Figure 8.** Energy dissipating ratios of the two rows without end sill energy dissipaters

When the energy dissipation ratios of the two rows of without end sill energy dissipation blocks are examined in Figure 15, it is seen that the highest energy dissipating rate is reduced by 51% with 20 l/s, which corresponds to almost 50% of the design flow.

### 3.2. Mathematical Modelling

The experimental setups of the single row energy reduction blocks used in the experimental study were tested with the FLOW-3D mathematical method at the design flow rate, and the data on the hydraulic properties obtained are given in

Table 2. When this table is analyzed, the energy breaking blocks with Trapezoidal cross-sections have energy breaking percentages is almost 39%.

**Table 2.** The results of mathematical modelling of the single row energy dissipating block

Type	h <sub>1</sub> (m)	V <sub>1</sub> (m/s)	E <sub>1</sub> (m)	h <sub>3</sub> (m)	V <sub>3</sub> (m/s)	E <sub>3</sub> (m)	(E <sub>1</sub> .E <sub>3</sub> )/E <sub>1</sub>	Fr <sub>1</sub>	Fr <sub>2</sub>
Trapezoidal	0,0480	2,75	0,4338	0,2495	0,53	0,2638	0,39	4,01	0,34

### 3.3. Comparison of Physical and Mathematical Model Results

Experimental setups of single row energy breaker blocks were tested physically at seven different flow rates and with the FLOW-3D mathematical method at the design flow. When the energy dissipation rates of the energy dissipating blocks are analyzed in Table 3, the experimental study results and the FLOW-3D results have almost the same values.

**Table 3.** Energy reducing rates obtained by mathematical modelling for the single row energy dissipating block at design discharge

Block	Physical modelling			Mathematical Modelling		
	h <sub>3</sub> (m)	V <sub>3</sub> (m/s)	(E <sub>1</sub> .E <sub>3</sub> )/E <sub>1</sub>	h <sub>3</sub> (m)	V <sub>3</sub> (m/s)	(E <sub>1</sub> .E <sub>3</sub> )/E <sub>1</sub>
Type	0,2485	0,53	0,39	0,2495	0,53	0,39
Trapezoidal	0,2515	0,53	0,39	0,2500	0,53	0,39

## 4. CONCLUSIONS

A series of experiments were carried out to investigate the similarities and differences of the dissipating ratios of the different layout of energy dissipating blocks placed in the USBR Type III energy dissipating pool, the experimental study and the mathematical model.

**Proceeding Book of ISESER 2023**

The results obtained according to the studies carried out shows that the energy-dissipating rates were all design are different. Hydraulic jump occurred in all experimental setups. Experimental study results and numerical model results had almost the same values.

**REFERENCES**

- Amorim, J. C. C., Amante, R. C. R., and Barbosa, V. D. (2015) “EXPERIMENTAL AND NUMERICAL MODELING OF FLOW IN A STILLING BASIN” in E-proceedings of the 36th IAHR World Congress. Hague, Netherlands.
- Bestawy, A. (2013) New Shapes of Baffle Piers Used in Stilling Basins as Energy Dissipators. *Asian Transactions on Engineering*, **3**(1).
- Bradley, J. N. and Peterka, A. J. (1957) Hydraulic Design of Stilling Basins: Hydraulic Jumps on a Horizontal Apron (Basin I). *Journal of the Hydraulics Division*, **83**(5), 1401–1. [online] <https://ascelibrary.org/doi/abs/10.1061/JYCEAJ.0000126> (Accessed April 26, 2022).
- Cook, C., Richmond, M. C., Serkowski, J. A., and Ebner, L. L. (2002) “Free-Surface Computational Fluid Dynamics Modeling of a Spillway and Tailrace: Case Study of The Dalles Project” in *Hydrovision 2002*. United States.
- Dermawan, V., Suhardjono, Prasetyorini, L. and Anam S. (2021) “Hydraulic Model Experiment of Energy Dissipation on thr Horizontal and USBR II Stilling Basin” *IOP Conferences, Earth and Environmental Science*, **930** (012029).
- Hager, W. H. (1992) *Energy Dissipators and Hydraulic Jump*, Dordrecht, Springer Netherlands. [online] <http://link.springer.com/10.1007/978-94-015-8048-9> (Accessed April 26, 2022).
- Kumcu, S. Y. and Kökpınar, M. A. (2019) “Application Of Numerical Modeling On Spilway Structures: A Case Study Of Kavsak Bendi Hydroelectric Power Plant (HEPP)” *DSI Technical Buletin*, **132**, 12-27.
- Nigam, U., Das, S., and Choudhury, M. R. (2016) “Overview of Energy Dissipators and Stilling Basins with Design Aspect of Hydraulic Jump Type Energy Dissipators” *NCIET2015*, 1-9.
- Pagliara, S. and Palermo, M. (2012) Effect of Stilling Basin Geometry on the Dissipative Process in the Presence of Block Ramps. *Journal of Irrigation and Drainage Engineering*, **138**(11), 1027–1031. [online] <https://ascelibrary.org/doi/abs/10.1061/%28ASCE%29IR.1943-4774.0000505> (Accessed April 26, 2022).
- Peterka, A. , J. , (1984) *Hydraulic Design of Stilling Basins and Energy Dissipators*, Denver, Colorado, United States Department of the Interior BUREAU OF RECLAMATION.

**O 55. EFFECTS ON EARLY DEVELOPMENT OF HEAT STRESS IN WHEAT (TRITICUM DURUM)**

Aida Dervishi<sup>1\*</sup>, Erika Hoxha<sup>1</sup>, Adriatik Cakalli<sup>2</sup>, Xhuliana Arapaj<sup>3</sup>

<sup>1</sup>*Department of Biotechnology, Faculty of Natural Sciences, University of Tirana, Albania*

<sup>2</sup>*Institute of Plant Genetic Resources, Agricultural University, Tirana, Albania*

<sup>3</sup>*Department of Biology, Faculty of Natural and Technical Sciences, University of Vlora "Ismail Qemali", Albania*

E-mail: *aida.dervishi@fshn.edu.al; hoxhaj.erika11@gmail.com; adcakli13@gmail.com; xhulianaarapaj@yahoo.com*

**ABSTRACT:** Heat stress, particularly during cereal crops germination and early development stage has a detrimental influence on their productivity. The predicted climate changes threaten the sustainable cultivation and production of crops. Therefore, the screening and the identification of heat stress tolerant genotypes is crucial for development of climate resilient cultivars. This study examined the impact of heat stress on germination rate and early development stages of wheat (*Triticum durum*) genotypes. Samples were subjected to diverse temperature conditions, encompassing a control temperature of 25°C as well as to higher temperatures of 30°C and 35°C. The germination percentage and rate, phenotypic traits and photosynthetic pigments concentrations were evaluated in the control and heat stress samples. The germination rate exhibited a slight increase when grains were exposed to 30°C as compared to control, whereas lower germination percentage and rate were observed in samples exposed to higher temperatures of 35°C. Moreover, significant differences were observed in both root and plant length with the increasing of temperature to 35°C. This heat stress induce effect was also observed in chlorophyll a, chlorophyll b amounts across all analysed genotypes, which decreased substantially at 35°C compared to the control. The comparative clustering analysis of 23 *T. durum* varieties employing morpho-physiological data of control group, and two heat stress treatments, a grouping emerged wherein heat resistant varieties were grouped together in response to the heat treatment. The study identified four resistant wheat lines that could be valuable source for breeders aiming to develop heat-tolerant varieties.

*Keywords: Heat Stress, Triticum Durum, Early Development*

**O 56. MORPHOLOGICAL DIVERSITY OF SALICORNIA EUROPEAE POPULATIONS**

Dhimiter Peci<sup>1\*</sup>, Aida Dervishi<sup>2</sup>, Klea Lame<sup>2</sup>, Xhuliana Arapaj<sup>3</sup>

<sup>1</sup>*Research Center of Flora and Fauna, Faculty of Natural Sciences, University of Tirana, Albania*

<sup>2</sup>*Department of Biotechnology, Faculty of Natural Sciences, University of Tirana, Albania*

<sup>3</sup>*Department of Biology, Faculty of Natural and Technical Sciences, University of Vlora “Ismail Qemali”, Albania*

E-mail: *dhimiter.peci@fshn.edu.al; aida.dervishi@fshn.edu.al; klea.lame@icloud.com;  
xhulianaarapaj@yahoo.com*

**ABSTRACT:** *Salicornia europea* L, also known as glasswort is a halophyte plant belonging to the Amaranthaceae family, known for its high plasticity. It grows in regions characterized by extremely high salinity as well as in the marginal areas. In the present study, *S. europea* populations were collected from four different areas, aiming to investigate the morphological diversity and identify key traits affected by different salinity levels. The growth and the biomass development of glasswort populations were evaluated through nineteen morphological traits. Our findings showed significant variation within the majority of the measured traits related to plant growth, while no variation was observed in the root architecture across the studied populations. Morphological traits had higher values in populations grown in environments characterized by high salinity levels, indicating that this species grows optimally in such saline habitats. Conversely, reduction of plant growth was observed in the populations grown in low salinity areas and those of extremely high salinity. Our results expanded the knowledge on the morphological diversity and the traits that are strongly influenced by soil salinity.

*Keywords: Salicornia Europeae, Halophyte, Morphologic Diversity*

O 57. MICROBIC QUALITY (CF/SF) AND SOME PHYSICO-CHEMICAL PARAMETERS IN SURFACE WATERS IN THE REGION OF SHKODRA, ALBANIA

Ornela Luka<sup>1\*</sup>, Klementina Puto<sup>1</sup>

<sup>1</sup>Department of Biotechnology, Faculty of Natural Science, University of Tirana, Albania

E-mail: [ornela.luka@qiriazhi.edu.al](mailto:ornela.luka@qiriazhi.edu.al), [klementina.puto@fshn.edu.al](mailto:klementina.puto@fshn.edu.al)

**ABSTRACT:** Today, everywhere in the world, even in Albania, microbial and chemical pollution of natural surface waters remains a problem, where there are still no sewage treatment plants. This situation is also problematic for the region of Shkodra, since most of the various surface waters of this region are not treated in advance. This paper has studied the CF/Sf microbial parameters and some physico-chemical parameters such as temperature, pH, nitrites, turbidity, in 12 stations in Lake Shkodra, Buna River and Velipoja lagoon. The study provides preliminary data for the parameters analyzed during the 4 months, June-September 2023. The main source of the pollution of these waters is from human activities and measures still truncated by the lack of preliminary treatment, mainly by microorganisms. The aim was to understand the levels of pollution and the possible causes of pollution in the quality of these water resources with many uses in this region.

*Keywords: Waters, River, Microbiological Parameters, Physical-Chemical Parameters*

## 1. INTRODUCTION

The quality of surface waters has a specific importance in the life of the regions in which they are located. These waters are connected to important economic activities, attractive to the public health of the inhabitants. The pollution of surface waters and their non-treatment constitutes today a threat to human health, the natural ecosystem and tourism in Albania. The region of Shkodra stands out for a diverse diversity of surface waters such as rivers, lakes, lagoons and the sea. Therefore, for the importance they represent both in the economy and tourism, it is important to prioritize their quality, which until now has been lacking. As for the marine waters in the north of Albania, one of the most important regions is the lagoon in Velipoja (Shkodër). Equally important are the Buna River, which flows into the Adriatic sea, whose waters are problematic because the waters of Lake Shkodra, the Drin River, etc., are polluted and untreated. The administrative center of Shkodër has recently seen an increase in economic activities and tourism, which is becoming a priority for the economy. For this reason, the quality of these waters takes on primary importance for the northern region of the country, but also beyond. Water quality is related to its physico-chemical and microbiological characteristics. Surface water pollution being one of the major environmental problems, we undertook the microbiological study based on bacterial indicators, *Faecal coliforms* and *Fecal streptococci* as well as physico-chemical water quality indicators of Shkodër Administrative Center. Based on the EU Directives of Surface Water (2006/7/EC) and the standards approved by the Albanian government for information on surface water, the analysis of 12 stations.

## 2. MATERIALS AND METHODS

Water sampling, storage, transport and analyzing was done according the Standard Methods of Water Examination (APHA, AWWA, WEF, 1998: APHA, AWWA, WEF, 2005)

Two parallel samples were taken for each point. One sample was taken for the determination of microbiological parameters and the other sample was taken for the determination of parameters physical – chemical. Water samples were taken at a depth of 30-50 cm from the surface of the water (WHO, 1995, APHA 1998, ISO 5667–2:1991). Microbiological quality was determined by the standard method most probable number (MPN) for *Faecal coliforms* and *Fecal streptococci* (APHA, 1970, APHA 1985). The samples were taken from June to September 2023, in 12 different stations. Preliminary test for *Faecal coliforms* the medium used is Lactose broth was incubated in incubate 35°C (LB) (APHA 1985). For the confirmation test it is used EC Broth. For all test tubes where turbidity is observed after 24 hours, a confirmation test is performed. It is incubated at a temperature of 44° ± 0.2°C for 24 ± 2 hours, (Wilrich P.2010). The detection and enumeration of *Faecal streptococci* was carried out using the MPN method



Proceeding Book of ISESER 2023

(WHO 1982; USEPA 1986; APHA 1998). In the preliminary test the medium used is Azide Dextrose Broth (ADB).(APHA 1998) Incubation was done at 37°C for 24 hours. The presence of turbidity was observed in the tubes, which is an indicator of the presence of *Faecal streptococci*, (Mallmann and Seligmann 1950, Rothe, 1948). For the confirmation test it is used (Ethyl violet azide broth) EVAB. Incubate at a temperature of 37°C for 24-48 hours. The formation of a purple stamp (bruise) at the end of the test tube or in any case the formation of a dense turbidity indicates the presence of *Faecal streptococci* (APHA 1998, Edwards S.J., 1933, Hartman G., 1937).

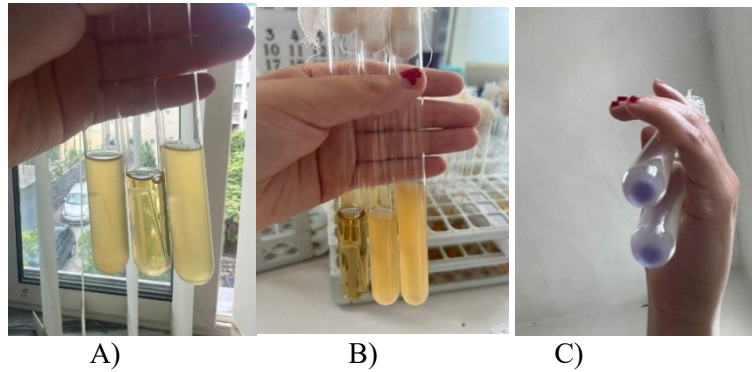

Figure 1. A, B The result of the samples (ECB) : C) The result of the samples(EVA)

3. RESULTS AND DISCUSSIONS

Referring to figure 2, it turns out that the Buna River in 3 stations, Darragjat Ura e bune, the junction of the Buna River with the Drini turns out to be polluted. The pollution happens in advance in these points, for example the bridge of Bune and Darragjat discharge the untreated sewage of the city of Shkodra and the village of Pulaj-Velipoje. Also, the place where the drin river joins the bunen shows a pollution beyond the norms, the water that collects all the water that is discharged from the surroundings of the region untreated in Shkoder. Also the lake of Shkodra in the center has a lot of pollution as the sewage of the restaurants located around it is discharged.

Based on the figure 2 and 3 it results that *Faecal coliforms* and *Fecal streptococci* the ratio between them shows that the pollution is mainly human

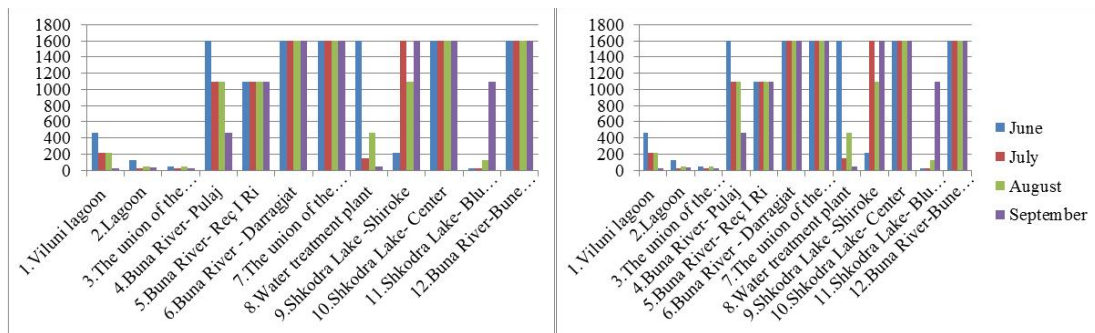

Figure 2. Level of microbial contamination of *Faecal Coliforms* according to the stations and months.

Based on the values suggested by the European standards (new Directive 2006/7/EC for surface water) for the content of *Faecal streptococci* it is classified "Excellent quality" in all analyzed stations

Proceeding Book of ISESER 2023

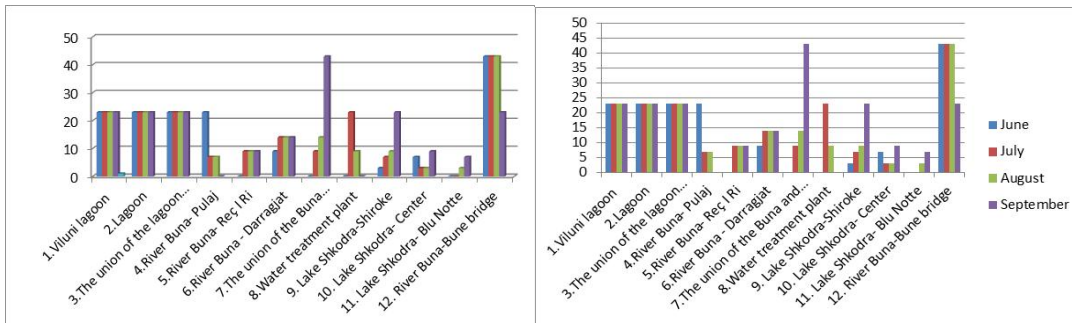

Figure 3. Level of microbial contamination of *Faecal streptococci* according to the stations and months.

From the analysis of the physico-chemical parameters, it results that the average temperature of the lake stations is about 24.4°C, in the Buna River it is about 23.4°C

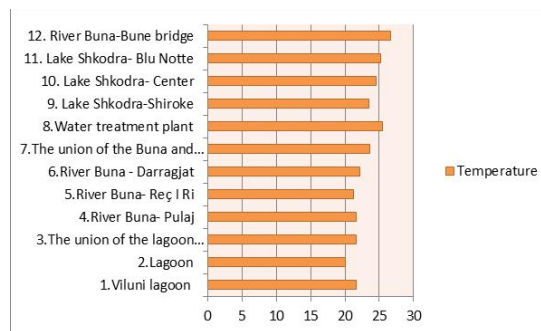

Figure 4. Distribution of temperature values according to stations

Also, the analysis of turbidity shows a high value at the point of the station where the sea joins the lagoon, unlike other stations where the values are low

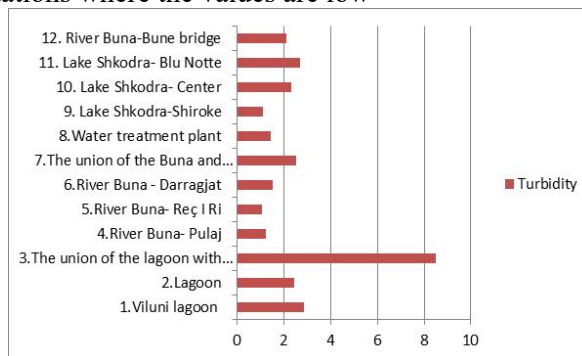

Figure 5. Distribution of turbidity values according to stations

High values of nitrites are found in the Buna-Darragjat River, while low values are found in the lagoon and Reç i Ri, which have a zero value.

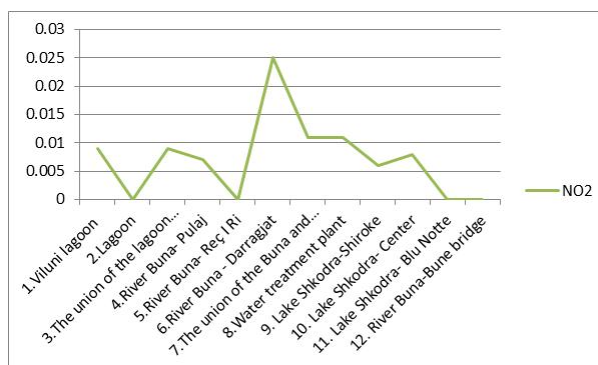

Figure 6. Distribution of nitrite values according to stations

#### 4. CONCLUSIONS

Based on the results, *Faecal coliforms* and *Fecal streptococci* the ratio between them shows that the pollution is mainly human

The highest pollution is located in the stations Darragjat Ura e bune, the junction of the Buna River with the Drini and Shkodra lake in the center where we have high anthropogenic activity and the water is not treated before discharge

The Viluni lagoon in Velipoje and the point where the lagoon joins the sea show low levels of microbial pollution

#### REFERENCES

- American Public Health Association (APHA) (1998): Standard methods for the examination of water and waste water. American Public Health Association, Washington D.C. (20th edition): 2124-2230
- American Public Health Association. 1970. Recommended Procedures for the Examination of Seawater and Shellfish, 4th ed. APHA, Washington, DC
- APHA (1998) Standard Methods for the Examination of Water and Wastewater, 20th Ed., , Washington, D.C.
- APHA, AWWA, WEF (2005): Standard methods for the examination of water and wastewater. 21. Washington: American Public Health Association, American Water Works Association, Water Environment Federation; pp. 1-564.
- Directive 2006/7/EEC: Directive concerning management of bathing water quality and repealing Directive 76/160/EEC. Official Journal of the European Union L. 64: 37-51.
- ISO 5667-2:1991 Water quality—Sampling—Part 2: Guidance on sampling techniques
- Mallmann and Seligmann , 1950, Am. J. Publ. Health, 40:286 , Rothe, 1948, Illinois State Health Department.
- Regulations and Standards Division. Washington, DC: United States Environmental Protection Agency, 18p.
- Standard Methods for the Examination of Water and Wastewater, (1985). Greenberg, A., et al., eds. 16th Edition. APHA. Washington, D.C
- US EPA (1986) Ambient water quality criteria for bacteria-1986. EPA440/5-84-002. Office of Water
- WHO (1982) Examination of water for pollution control. Part III: Biological, Bacteriological and Virological Examination., ed. Oxford. Pergamon Press, World Health Organization.
- WHO (1995). Manual for recreational water and beach quality monitoring and assessment. Draft. WHO, Regional Office for Europe, European Centre for Environ. and Health
- Wilrich P. (2010): Reconsiderations of the derivation of Most Probable Numbers, their standard deviations, confidence bounds and rarity values. Journal of Applied Microbiology

**P 1. A STUDY OF DIATOM DISTRIBUTION AND BIODEIVERSITY IN FRESH WATER  
OF VJOSA RIVER**

Elona Bahiti<sup>1</sup>, Lirika Kupe<sup>1\*</sup>, Marsela Alikaj<sup>1</sup>, Alma Imeri<sup>1</sup>, Irena Duka<sup>2</sup>

<sup>1</sup>*Department of Agronomic Sciences, Faculty of Agriculture and Environment, Agriculture University  
of Tirana, Tirana, Albania*

<sup>2</sup>*Department of Environment and Natural Resources, Faculty of Agriculture and Environment,  
Agriculture University of Tirana, Tirana, Albania*

E-mail: \*[lkupe@ubt.edu.al](mailto:lkupe@ubt.edu.al)

**ABSTRACT:** During the NASRI project we realized a several field trips on Vjosa river from October 2021 to July 2023. In this paper we will present diatom species which were collected in May 2021. Samples were collected as periphyton upper the stones or in Chladophora sp., from representative station in: Mifol (Vlore), Poçem (Mallakaster), Memaliaj, Tre urat, Sajmola (Kelcyre), Dragot and Vjosa in Kelcyra (near the source of black water). In total we have collected seven samples. Together with its tributaries, the Vjosa provides a dynamic, near-natural ecosystem, at the same time, the Vjosa represents a unique chance for European river science to assess the ecology of wild rivers. The assessment of the biological and ecological conditions of the river waters is an important factor in the protection of the biodiversity of species in the Vjosa river. We identify 100 diatom species where two belong centric diatom and others belong pennate diatoms. Based on presence of diatoms in sampling sites, more widespread diatoms were: *Brachysira neoexilis* Large Bertalot, *Cocconeis pediculus* Ehrenberg, *Cocconeis placentula* var. *lineata* (Ehrenberg) Van Heurck, *Cymbella minuta*, *Diatoma moniliformis* Kützing, *Gomphonema pumilum* Grunow, *Cocconeis placentula* var. *placentula* etc. Some of diatom's species were found rarely which included: *Diatoma tenuis*, *Encyonema silesiacum*, *Fragilaria capucina*, *Fragilaria tenera* Lange-Bertalot, *Gomphonema olivaceum* (Hornemann), *Nitzschia dissipata*, etc. In some samples we have collected green algae like as *Chladophora* sp. Also, diatoms used as long-term indicators of the ecological status of freshwater.

*Keywords: Vjosa River, Biodiversity, Diatoms, Floristic Data*

## **1. INTRODUCTION**

The Vjosa and its main tributaries flow freely for more than 400 km, from the Pindus Mountain Range in Greece to the Adriatic coast in Albania. The Vjosa Wild River National Park proclaimed in 2022, is a National Park categorised under IUCN's Protected Area Management Category II. The main aim of the park is to preserve the natural biodiversity and ecological structure, facilitate environmental processes, and encourage education and recreation. The use of technical terms has been kept to a minimum and when necessary, they have been defined clearly and spelled out in full when first mentioned. The river and its environs constitute significant ecosystems of biodiversity, harbouring over 1,100 animal species such as 13 globally threatened animal species and two plant species evaluated by IUCN. Biological monitoring has several advantages compared to chemical monitoring, as it summarizes biota data over a wider timescale and area of pollution. This has been highlighted by Calow & Petts (1994) and John (2002). Diatom communities serve as a popular tool for assessing past and present environmental conditions and are frequently used in studies pertaining to water quality. Biomonitoring techniques, which have been established for 100 years (Kolkwitz & Marsson, 1908), have been employed in freshwaters to reveal the impact of various sources of pollution. Vjosa presents an exceptional opportunity for European river science to evaluate the ecology of natural rivers. The appraisal of biological and ecological conditions in the river is imperative for preserving biodiversity of species in the Vjosa river. For biological monitoring, we referred to the Water Framework Directive (WFD: European Union 2000, Foster et al. 2001, Kelly M. 2013). The WFD monitors the ecological

## Proceeding Book of ISESER 2023

state of water bodies. The distribution of diatoms is highly correlated with temperature, light intensity, aquatic physical-chemical characteristics, and seasonal variations. The influence from organic or inorganic matter is reflected by distribution of diatoms community. The dominant diatom taxa belong a pennate species in all samples.

The aim of this study is the assessment of the species composition of microscopic algae (diatoms) as indicators for evaluating water quality according to EU directives. The measurement of diatom population variance across sampling sites is assessed through the computation of various number of species to dominance and water ecology.

## 2. MATERIAL AND METHODS

### 2.1. Site sampling

This study presents the species of diatoms that were collected in May 2021 from seven sampling locations. The sampling locations include: Mifol (Vlore), Poçem (Mallakaster), Memaliaj, Tre urat on the Albanian-Greek border, Sajmola (Kelcyre), Dragoti, and Këlcyra near the source of "Black Water" (refer to Table 1).

**Table 1:** Sampling sites with their coordinates in Vjosa river

May-22	
Sampling sites	Coordinates
Ura e Mifolit (Vlorë)	40°38'02.8"N 19°27'40.5"E
Poçem (Mallakastër)	40°31'41.3"N 19°43'41.5"E
Memaliaj	40°21'05.2"N 19°58'06.8"E
Sajmola	40°17'44.3"N 20°06'29.9"E
Tre Urat (Përmet)	40°04'20.0"N 20°35'19.8"E
Kelcyre	40°30'56237.N 20°182'6817E
Dragot	40°29'23368"N 20°07'88.407E

### 2.2. Biological investigation

Our research aims to investigate diatom communities through microscopic analysis. The suspensions produced during the experiment were collected in small bottles and preserved in 4% formaldehyde for safekeeping, as previously outlined in research by Prygiell and Coste (1993), Kelly and Whitton (1995), and Lund et al. (1958). Diatom frustules were purified by boiling in H<sub>2</sub>O<sub>2</sub>cc (EN13946:2003). Species composition data was obtained by counting approximately 500 valves per slide using 100 oil immersion views. This method produced a 95% confidence level. Additionally, we consulted previous studies by Prygiell & Coste, 1993. The identification and enumeration of microscopic algae were conducted using an optical microscope that was equipped with a 100x objective lens. Abbreviations of technical terms will be explained upon first use. Diatoms were recognized employing recognized literature sources (Cleve – Euler 1955; Pascher 1976; Krammer & Bertalot 1996-2001, Algalbase, 2020).

## 3. RESULTS AND DISCUSSION

In the seven stations of Vjosa river, we found about 75 species of diatoms from our collected samples (Tab. 2). Diatoms are crucial microscopic algae and reflect the current environmental conditions at the sampling site. Their identification at a species level is possible via microscopy and serves as a reliable metric while assessing water eutrophication (Hall et al., 1999). Centric diatoms have a low relative abundance. The water quality is reflective of this relative abundance. The most dominant species in all samples was classified as a pennate diatom. The most widespread diatoms belong to the *Cocconeis* genus, particularly *Cocconeis placentula* var. *lineata*, which is present at all sampling station, as well as *Cymbella affinis*, *Gomphonema olivaceum*, *Navicula cryptotenella*, *Diatoma hyemalis*, *Diatoma moniliformis*, and *Achnanthes exilis*. The station of Sajmola-Kelcyre yielded the greatest diatom abundance, with the most prevalent species being *Cymbella affinis* with 240 shells in Sajmola in Kelcyra and 105 shell at Tre urat, but the low number of frustules were identified in Pocem, Mifol and Memaliaj.

Proceeding Book of ISESER 2023

We are encountering a similar situation with the *Gomphonema olivaceum* var. *olivaceum*; approximately 250 frustules were counted in Sajmola while only 110 in Kelcyra station. *Diatoma messodon* has approximately 475 frustules in the Sajmola station, while *Diatoma hyemalis* has about 222 frustules in the same station. According to our analysis, the Sajmola and Kelcyre stations displayed the highest diatom counts (Table 2), with the foremost species being *Cymbella affinis*, *Gomphonema olivaceum* var. *olivaceum*, *Diatoma messodon*, *Diatoma hyemalis*, and others. In contrast, Mifol had the least species diversity, while Sajmola-Kelcyre, Dragot, and Tre Urat displayed a high number of species. The undisturbed hydrological regime along the entire Vjosa River and its tributaries is an essential component for supporting the diverse range of rare, endangered and endemic species in the Vjosa River Valley. This valley contains notable biological and ecological features and landscapes that house habitats for plants and animals as well as areas of geodiversity (IUCN, 2021-011). These locations possess also significant spiritual, scientific, educational, recreational, or tourism value.

**Table 2:** Distribution of diatoms in the Vjosa river stations, May 2022

Table of species	Mifol (Vlore)	Pocem (Mallakaster)	Memaliaj	Dragot	Sajmola\Kelcyre	Kelcyre	Tre urat
Time of sampling	May, 2022						
Name of species	Nr	Nr	Nr	Nr	Nr	Nr	Nr
<b>Centric</b>							
<i>Cyclotella ocellata</i> Pantocsek				3			
<i>Melosira varians</i> Agardh		+					
<b>Pennate</b>							
<i>Achnanthes biasolettiana</i> GRUNOW	1						
<i>Achnanthes exilis</i> Kützing	24			94		1	185
<i>Achnanthes bryophila</i> J.B.Petersen					5		
<i>Achnantheidium eutrophilum</i> (Lange-Bertalot)						3	
<i>Amphora pediculus</i> (Kützing) Grunow		25					
<i>Asterionella formosa</i> Hassall							1
<i>Cocconeis pediculus</i> Ehrenberg	4	22					45
<i>Cocconeis placentula</i> Ehrenberg agg.	3						
<i>Cocconeis placentula</i> var. <i>lineata</i> (Ehrenberg) Van Heurck	14	240	50	130	85		215
<i>Cocconeis placentula</i> var. <i>euglypta</i> (Ehrenberg) Grunow				8			
<i>Cocconeis placentula</i> var. <i>placentula</i>		27					
<i>Cymbopleura</i> cf. <i>diminuta</i>						5	
<i>Cymatopleura solea</i> (Brebisson) W.Smith	1						
<i>Cymbella affinis</i> Kützing agg.	9	1	7	98	240	240	105
<i>Cymbella alpina</i> Grunow					6		
<i>Cymbella hungarica</i> (Grunow) Pantocsek	1						
<i>Cymbella minuta</i> Hilse, 1862					22		
<i>Cymbella tumida</i> Brebisson	2						
<i>Cymbella tumidula</i> Grunow	3				15	5	
<i>Cymbella tumidula</i> var. <i>lancettula</i> Krammer							4
<i>Cymbella silesiaca</i> Bleisch	1					8	

Proceeding Book of ISESER 2023

Table of species	Mifol (Vlore)	Pocem (Mallakaster)	Memaliaj	Dragot	Sajmola\Kelcyre	Keleyre	Tre urat
Time of sampling	May, 2022						
Name of species	Nr	Nr	Nr	Nr	Nr	Nr	Nr
<i>Denticula thermalis</i> Kützing	4						
<i>Denticula subtilis</i> Grunow							20
<i>Diatoma ehrenbergii</i> Kützing					13		
<i>Diatoma mesodon</i> Ehrenberg Kützing			3		475		
<i>Diatoma moniliformis</i> Kützing	1		2		45	5	73
<i>Diatoma hyemalis</i> (Roth) Heiberg					222		
<i>Diatoma vulgaris</i> Bory gr.	1	1		2			
<i>Diatoma vulgaris morphotyp distorta</i>					16		
<i>Encyonema silesiacum</i>				5			
<i>Encyonema ventricosum</i>	1			5	11	5	
<i>Eunotia bilunaris</i> Ehrenberg	1						
<i>Fragilaria berelinensis</i> Hustedt			1				3
<i>Fragilaria biceps</i>					1		
<i>Fragilaria capucina</i> var. <i>mesolepta</i> (Rabenh.)					2		
<i>Fragilaria ulna</i> (Nitzsch.) Lange-Bertalot var. <i>ulna</i>	3				2	1	
<i>Fragilaria acus</i> (Kützing) Lange-Bertalot	1						
<i>Fragilaria tenera</i> Lange -Bertalot	1				2		4
<i>Gomphonema angustum</i> Agarth				18	10	5	14
<i>Gomphonema minutum</i> (Agardh) Agardh agg.	5	2	35				10
<i>Gomphonema minutum</i> var. <i>minutum</i>			25	75			10
<i>Gomphonema affine</i> Kützing	1						
<i>Gomphonema clavatum</i> Ehr.	4		5		17		
<i>Gomphonema stauroneiforme</i> Grunow			5	19			22
<i>Gomphonema species cf. pumilum</i>				10			
<i>Gomphonema pumilum</i> var. <i>elegans</i>					27		
<i>Gomphonema pumilum</i> Grunow	6	1	8	42			52
<i>Gomphonema truncatum</i> Ehrenberg					7		
<i>Gomphonema tergestinum</i> Grunow	1					2	
<i>Gomphonema vibrio</i> Ehrenberg	19						
<i>Gomphonema ventricosum</i> Gregory				92			
<i>Gomphonema olivaceum</i> (Hornemann)				40		10	
<i>Gomphonema olivaceum</i> var. <i>minutissimum</i> Hustedt				105	80	52	
<i>Gomphonema olivaceum</i> var. <i>olivaceum</i>				65	250	110	50
<i>Gomphoneis transylvanica</i> (Pantocsek) Krammer					15		
<i>Gyrosigma wansbeckii</i> (Donkin) Cleve						1	
<i>Meridion circulaire</i> (Grewille) Agardh	5				2		
<i>Navicula clementis</i> Grunow	2						

Table of species	Mifol (Vlore)	Pocem (Mallakaster)	Memaliaj	Dragot	Sajmola\Kelyre	Kelyre	Tre urat
Time of sampling	May, 2022						
Name of species	Nr	Nr	Nr	Nr	Nr	Nr	Nr
<i>Navicula cryptotenella</i> Lange-Bertalot	4			5	37		
<i>Navicula cryptotenelloides</i> Lange-Bertalot		4					
<i>Navicula dealpina</i> Lange-Bertalot					4		
<i>Navicula molestiformis</i> Hustedt					17		
<i>Navicula incertata</i> Lange-Bertalot					5		
<i>Navicula tripunctata</i> (O. F. Müller) Bory	1						
<i>Nitzschia diversa</i> Hustedt	1						
<i>Nitzschia monochorum</i> L-B				4			
<i>Nitzschia palea</i> Kutzing					1		
<i>Nitzschia dissipata</i> (Kützing) Grunow var.dissipata	2						
<i>Nitzschia vermicularis</i> Kutzing	3						
<i>Rhoicosphaenia abbreviata</i> (Agardh) Lange-Bertalot				7		2	3
<i>Rhopalodia gibba</i> (Ehrenberg) O.Müller						1	

#### 4. CONCLUSION

In this study, a large number of diatoms were found collected in seven different stations. Most species are pennate, and a very limited number are centric. The most dominant species are: *Cocconeis placentula* var. *lineata*, *Cymbella affinis* Kützing agg. *Diatoma mesodon*. The relative abundance is reflected in the water quality. Monitoring of River waters, including here even their biological monitoring, can help to reach more accurate conclusions on water quality, so that possible risks to the living and human health are prevented. Historical impacts sources to biodiversity in Vjosa are from; agriculture, urban pollution Industrial pollution (especially from coal mining in Memaliaj), tourism activities ect. Biological and ecological conditions of the river waters is an important factor in the protection of the biodiversity of species.

#### ACKNOWLEDGMENT

Authors gratefully acknowledge the Albanian National Agency for Scientific Research and Innovation (NASRI) which supports financially our project entitled: "Assessment of the ecology of the waters of the Vjosa River catchment based on microalgae and physico-chemical parameters".

#### REFERENCES

- Calow P, Petts GE, 1994, The rivers handbook, Blackwell Scientific Publications, Oxford, Vol 2; 3-22.
- CEMAGREF, 1982, Étude des methods biologiques d'appréciation quantitative de la qualité des eaux. Rapport Q.E. Lyon - Agence de l'Eau Rhône-Mediterrane Corse, 218.
- Cleve A. – Euler, 1951-1955, Die Diatomeen von Schweden und Finnland, Teil I - V. Almqvist & Wiksells Boktryckeri AB, Stockholm.
- Directive 2000/60/EC: Directive of the European parliament and of the Council of Establishing a Framework for Community action in the field of water policy. Official Journal of the European Communities L 327/1.



**Proceeding Book of ISESER 2023**

- Dr Andrej Sovinc, 2021, Protection study of the Vjosa River Valley based on IUCN protected area standards (IUCN, [iucn.org/library/sites/library/files/documents/2021-011-En.pdf](https://www.iucn.org/library/sites/library/files/documents/2021-011-En.pdf))
- Hall R. I. and Smol J. P., 1999, Diatoms as indicators of Lake Eutrophication. In: Stoermer, E. F. and J. P. Smol (eds.), *the Diatoms: Applications for the Environmental and Earth Sciences*. Cambridge Univ. Press, Cambridge, 128-168.
- <https://www.iucn.org/press-release/202303/vjosa-one-our-last-wild-rivers-becomes-europes-first-wild-river-national-park> <https://www.vjosanationalpark.al/>
- John J., 2002, Bioassessment of health of aquatic systems by the use of diatome. In: *Modern Trends in Applied Ecology*. Ed. Ambasht RS, Ambasht NK, Kluwer Ac./Plenum Publishers, 20.
- Kelly MG, Whitton BA., 1995, The trophic diatom index: a new index for monitoring eutrophication in the rivers. *Journal of Applied Phycology*, 7; 433-444.
- Kolkwitz R. & Marsson M., 1908, Ökologie der pflanzlichen Saprobien, *Berichte der Deutschen Botanischen Gesellschaft*, 26a, 505-519.
- Krammer K., Lange-Bertalot H., 1986-2001, *Subswasserflora von Mitteleuropa*. Fischer, Stuttgart., 2/1: pg. 876; 2/2: pg. 596; 2/3: pg. 576; 2/4: pg. 437; 2/5.
- Kupe L, Schanz F, Bachofen R., 2008, Biodiversity in the benthic diatom community in the upper river Toss reflected in water quality indices. *Clean Journal*, 36 (1); 84-91.
- Lund et al., 1958, The inverted microscope method of estimating algal numbers and the statistical basis of estimations by counting, *Hydrobiologia*, Vol. 2; 143 – 170.
- Pascher A., 1976, *Süßwasserflora von Mitteleuropa*, Heft 10, Jena 1930,
- Prygiell J, Coste M., 1993, Utilisation des indices diatomiques pour la mesure de la qualité des eaux du bassin Artois-Picardie : bilan et perspectives. *Annls Limno*, 29 (3-4); 255-267.

**P 2. ASSESSMENT OF ECOLOGICAL STATUS OF VJOSA RIVER IN ALBANIAN, BASED ON CHEMICAL INDICATORS AND BIOMONITORING**

Marsela Alikaj<sup>1</sup>, Lirika Kupe<sup>1\*</sup>, Elona Bahiti<sup>1</sup>, Alma Imeri<sup>1</sup>, Irena Duka<sup>2</sup>

<sup>1</sup>*Department of Agronomic Sciences, Faculty of Agriculture and Environment, Agriculture University of Tirana, Tirana, Albania*

<sup>2</sup>*Department of Environment and Natural Resources, Faculty of Agriculture and Environment, Agriculture University of Tirana, Tirana, Albania*

E-mail: \*lkupe@ubt.edu.al

**ABSTRACT:** Water ecosystems are the main assets of our country, especially Vjosa River as the last wild river in Europe. Vjosa is a national park and is considered as the blue heart of Europe. Thus, continuous assessments are necessary for preserving of water quality and conserving biodiversity of water ecosystem. Nowadays, the studies of water ecosystems are focused in chemical monitoring and biomonitoring too. Traditional measures of water quality are based on physico-chemical parameters but using biomonitoring especially diatoms algae we can evaluate historical pollution of water ecosystems. Our study was focused in the assessment of water quality and ecological status of Vjosa River, based on chemical and biological parameters. During 2021-2022 in five sampling points were collected water samples and biological samples. Water samples were analysed for NH<sub>4</sub><sup>+</sup>, NO<sub>2</sub><sup>-</sup>, NO<sub>3</sub><sup>-</sup> and PO<sub>4</sub><sup>3-</sup> as chemical parameters. Biological samples were analysed for microalgae as diatoms. The values of ammonium ranged from 0.035 to 0.09mg/l. NO<sub>2</sub> from 0.008 to 0.083mg/l and NO<sub>3</sub> varied from 0.125mg/l to 0.32mg/l. The values of phosphates ranged from 0.01 to 0.08mg/l. Vjosa River resulted to be in a high and good quality, compared with WFD. Based on diatoms, 96 species were found in 5 sampling points and their ecological values show a trophic status that range from oligotroph up to meso-eutrophic. Also, a PCA analysis in SPSS 20 program was used to see the correlation that existed between chemical and biological parameters.

**Keywords:** *Vjosa River, National Park, Ecological Status, Biomonitoring, Diatoms Algae*

## **1. INTRODUCTION**

Water ecosystems are the main assets of our country, especially Vjosa River as the last wild river in Europe. Vjosa is a national park and is considered as the blue heart of Europe. The Vjosa river flows from northwestern Greece to southwestern Albania, spanning approximately 272 kilometres in total length. The Greek section of the river covers the first 80 kilometres while the Albanian section covers the remaining 192 kilometres. The average discharge of the Vjosa river is 195m<sup>3</sup>/s. Notable tributaries include Voidomatis and Sarantaporos in Greece, and Drino and Shushicë in Albania. Vjosa river is the place when people can raft in its meandering waters, hike and camp in its lush forests, or climb and swim in its impressive canyons with crystal water. Vjosa has a rich environment, from microscopic organisms to threatened species, which are essential to the ecosystem of the waterway. More than 150-winged insect species, roughly 60 mollusc species, a minimum of 31 fish species, 31 reptile species, 257 bird species, around 70 mammal species, and over 350 plant species live there (ActaZooBot, 2018). Water ecosystem is of particular importance, including here the uses of water for swimming, fishing, irrigation or drinking waters (Kupe & Alikaj, 2020). Therefore, it is essential to conduct continuous assessments to maintain healthy ecosystems. Chemical assessment and biomonitoring are closely related in the evaluation of water ecosystems. Chemical monitoring allows us to evaluate the current state of waters, but biomonitoring holds several advantages over chemical monitoring as it summarises the biota's response to a range of pollutants in water ecosystems over time (Alikaj et al., 2022). This study aims the evaluation of trophic status of Vjosa river, based on chemical parameters and diatoms algae. Furthermore, to compare the results that come from two types of monitoring in order to give the best correlation that exist between them and the importance of each monitoring form.

Proceeding Book of ISESER 2023

## 2. MATERIAL AND METHODS

### 2.1. The study area, Water and diatom algae sampling

The Vjosa river was the focus of our study (figure 1). Five sampling points along the Vjosa River were determined and three expeditions from November 2021 to October 2022 were realized. Samples for chemical analyses and diatoms algae were collected at the same sampling points. The parameters like pH, temperature, were measured on-site using portable apparatus. The samples for chemical parameters were transported to the laboratory in refrigerated containers at a temperature of 4°C and were subsequently analysed within 24 hours and ISO standard methods (5, 6, 7, 8) were used during analysis. The laboratory responsible was accredited and belonged to the Department of Environment and Natural Resources at the Agricultural University of Tirana.



Figure 1. Vjosa river and the sampling points.

Diatom algae material was obtained by gently scraping the upper surface of selected rocks from the river using a toothbrush. The resulting suspensions were collected and preserved in 4% formaldehyde (Kupe & Alikaj, 2020). Diatom frustules from organic and inorganic sources were purified by boiling the material. Initially, the material was treated with HClcc and then, after washing, boiled again with H<sub>2</sub>SO<sub>4</sub>cc. During the final procedure, some crystals of KNO<sub>3</sub> were added as per the protocol described by Krammer and Lange-Bertalot (4). Biological analysis (for diatoms), at Botany laboratory of Agronomic Sciences Department. Chemical analysis was compared with the WFD (11) standard, and trophic classes were determined for each station by calculating the Trophic Diatom Index (TIDIA) for diatoms algae. To identify correlations between chemical and biological parameters, PCA analysis was performed using the SPSS 20 program.

## 3. RESULTS AND DISCUSSION

Results of chemical analysis are shown in table 1. The situation of nutrients in water are in a good amount. The levels of ammonium in the Vjosa river were found to be of high quality according to the WFD. The NH<sub>4</sub><sup>+</sup> values fall within a range of 0.035 mg/l to 0.09 mg/l, whereas the NO<sub>2</sub> values range from 0.008 mg/l to 0.083 mg/l. The quality of Vjosa river's waters has been classified as high to moderate based on nitrite values. However, at Çarshovë point, the situation is moderate due to the discharge of waters from Sarandoporos river.

The nitrates values varied from 0.12 mg/l to 0.32 mg/l, while the phosphates values ranged from 0.01mg/l to 0.08 mg/l. Based on these values, the quality of water for nitrates can be determined as first class of water quality according to WFD and phosphates are of first class mostly.

**Table 1.** Chemical parameters at Vjosa river

Parameters	Tem, H <sub>2</sub> O	pH	NH <sub>4</sub> <sup>+</sup>	NO <sub>2</sub> <sup>-</sup>	NO <sub>3</sub> <sup>-</sup>	PO <sub>4</sub> <sup>3-</sup>
Unit	°C		mg/l	mg/l	mg/l	mg/l
Tri urat	13,9	8,215	0,09	0,083	0,125	0,08
Sajmola	14	7,9	0,04	0,028	0,3	0,06
Memaliaj	15,83	8,33	0,04	0,008	0,25	0,03
Poçem-Aragosta	15,66	8,14	0,045	0,012	0,24	0,01
Mifol	16	8,085	0,035	0,036	0,32	0,02
Max	16	8,33	0,09	0,083	0,32	0,08
Min	13,9	7,9	0,035	0,008	0,125	0,01

Ninety-six species of diatom algae were identified in the five sampling points (refer to Table 2). The number of species varies from 10 at Mifol and Memaliaj stations to 33 species at Poçem station. The trophic diatom index ranges from 1.2 at Sajmola to 1.9 at Mifol station. Consequently, the waters of Vjosa River exhibit trophic classes ranging from Oligotroph to Meso-eutroph at Mifol. Based on diatoms, Vjosa River's quality can be classified as moderate, primarily due to the presence of inorganic matter. The saprobic index values range from 1.1 at Memaliaj to 1.5 at Mifol and Tre-urat. These saprobic indexes correspond to oligosaprob to β-mesosaprob, indicating that the water quality is excellent. Therefore, we can conclude that there is no organic matter present in the Vjosa river.

Four parameters of chemical analysis, the total number of diatom species, saprobic index (which determines organic matter) and the diatom species with the largest numbers were included in the PCA analysis (table 3).

**Table 2.** Data of diatoms algae in each station

Table of species	Poçem	Mifol	Memaliaj	Sajmola\ Kelcyre	Tre urat
	p%	p%	P%	p%	p%
<b>Number of species, N:</b>	33,0	10,0	10,0	31,0	18,0
<b>Trophic Diatom Index, TI<sub>DIA</sub>:</b>	1,7	1,9	1,8	1,2	1,5
<b>Trophic classes</b>	Mesotroph	Meso-eutroph	Mesotroph	Oligotroph	Oligo-mesotroph
<b>Quality</b>	Moderate	Poor	Moderate	Very good	Good
<b>Saprobic Index, SI</b>	1,4	1,5	1,1	1,3	1,5
<b>Saprobic classes</b>	Oligosaprob	Oligosaprob to β-mesosaprob	Oligosaprob	Oligosaprob	Oligosaprob to β-mesosaprob
<b>Quality</b>	Very- very Good	Very good	Very- very Good	Very- very Good	Very good

Based on the correlation of these parameters, it can be concluded that the parameters were separated into three components: diatom algae species such as *Cymbella affinis*, *Diatoma mesodon*, *Diatoma hyemalis*, and *Gomphonema olivaceum var. olivaceolacum*, which had higher correlation coefficients, were associated with higher levels of phosphates. This indicates that an increase in phosphate concentrations leads to a greater number of diatom species. Similarly, a correlation between the number of species and phosphates reveals the same outcome. In addition, we can conclude that the aforementioned species are highly susceptible to changes in inorganic substances.

**Table 3.** Components and the correlation of parameters in PCA analysis

Structure Matrix	Component		
	Diatoms algae	Inorganic matters	Organic matters
N-NH <sub>4</sub>		,972	,505
N-NO <sub>3</sub>		-,973	
N-NO <sub>2</sub>		,817	,769
P-PO <sub>4</sub>	,816	,483	
SI			,960
Nr. Of species	,969		
<i>Achnanthes exilis</i>		,975	,528
<i>Cocconeis pediculus</i>		,424	,912
<i>Cocconeis placentula var lineata</i>		,669	,779
<i>Cymbella affinis</i>	,968		
<i>Diatoma mesodon</i>	,941		
<i>Diatoma hyemalis</i>	,944		
<i>Gomphonema olivaceum var olivaceolacum</i>	,990		

Extraction Method: Principal Component Analysis.  
Rotation Method: Oblimin with Kaiser Normalization.

The second component pertains to inorganic substances and is mostly associated with species such as *Achnanthes exilis*, *Cocconeis pediculus* and *Cocconeis placentula var lineata*. Two types of correlation are observed: a positive correlation between these species and ammonium and nitrites, and a negative correlation between species and nitrates. These species grow and are stimulated by changes in the amount of ammonium and nitrites. However, a negative correlation indicates that diatoms increase their numbers during periods of high nitrate levels. The increase in the number of diatoms results in a reduction of nitrates, as they use them for growth. Nitrate (NO<sub>3</sub><sup>-</sup>) is the main nutrient required for diatoms to grow and develop well. The high concentration of nitrate in the water will stimulate the growth of the diatom, because nitrate in certain concentrations provides a good condition for the diatoms to grow (E D Masithah et.al, 2019). The third component comprises organic matter. The strong correlation observed between *Achnanthes exilis*, *Cocconeis pediculus*, and *Cocconeis placentula var. lineata* implies that these species are susceptible not only to inorganic matter, but to organic matter as well.

#### 4. CONCLUSION

The chemical parameters and diatom species of Vjosa River demonstrate that the ecosystem is in good condition. There is a discernible correlation between species and chemical components. The abundance of diatoms is affected differently by nutrient variations, such as phosphates, nitrites, and nitrates. A correlation between species and nitrates demonstrated that diatoms thrive in an abundance of nitrates. The increase in diatom count leads to a reduction in nitrates within the water ecosystem.

#### ACKNOWLEDGMENT

We gratefully acknowledge the National Agency for Scientific Research and Innovation (NASRI) which supports financially our project. Project title: "Assessment of the ecology of the waters of the Vjosa River catchment based on microalgae and physic-chemical parameters".

**Proceeding Book of ISESER 2023**

**REFERENCES**

- Alikaj M., Kupe L., Bahiti E., Brahushi F., 2022, Comparison of ecological status in two lakes in Albania based on diatoms algae. *Fresenius Environmental Bulletin*. Volume 31-No. 08A. ISSN 1018-4619, P. 8404-8409. IF: 0.618
- E D Masithah, D D Nindarwi , T Rahma and R R Satrya P I., 2019, Dynamic Ratio Correlation of N:P in relation to the Diatom Abundance in the Intensive System of the Vannamei (*Litopenaeus vannamei*) Shrimp Pond. *The 1st International Conference on Fisheries and Marine Science IOP Conf. Series: Earth and Environmental Science* 236.
- ISO 6878, 2004, Water Quality-Determination of phosphorus-Ammonium molybdate spectrometric method.
- ISO 7150, 1984, Water Quality-Determination of N-NH<sub>4</sub>. Spectrometric method.
- ISO SSH 7890/1, 2000, Water Quality-Determination of N-NO<sub>3</sub>. Spectrophotometric method with 2, 6-dimethylphenol.
- Krammer, K., Lange-Bertalot, H., 1986-2001, Bacillariophyceae. *Freshwater flora of Central Europe*. 2/1: pp. 876; 2/2: pp. 596; 2/3: pp. 576; 2/4: pp. 437; 2/5: Fischer, Stuttgart. Part 1-5, Gustan Fischer Stuttgart-New York.
- Kupe L., Alikaj M., 2020, Evaluation of diatom taxa in Alpin fresh water, Valbona River. *International scientific journal, Mechanization in Agriculture & Conserving of Resources/ Issues 1*, 2020. ISSN 2603-3704; ISSN web 2603-3712. P. 39-41.
- SSH EN 6777, 1993, Water Quality-Determination of N-NO<sub>2</sub>. Spectrophotometric method.
- The Vjosa in Albania, 2018, A riverine ecosystem of European significance. *Acta ZooBot Austria* 155.
- WFD 2000/60/EC: The Water Framework Directive – integrated river basin management for Europe. Directive 2000/60/EC of the European Parliament of the Council establishing a framework for the Community action in the field of water policy, adopted/on/23/October/2000 <http://ec.europa.eu/environment/water/waterframework/>

### P 3. DETERMINATION OF PHYTOCHEMICAL COMPONENTS OF ACHILLEA MILLEFOLIUM IN DIFFERENT AREAS OF ALBANIA

Edlira Kaloshi<sup>1</sup>, Lirika Kupe<sup>2\*</sup>, Kleva Shpati<sup>1</sup>, Marsela Alikaj<sup>2</sup>

<sup>1</sup>Albanian University, Faculty of Medical Sciences, Department of Pharmacy.

<sup>2</sup>Agricultural University of Tirana, Faculty of Agriculture and Environment, Department of Agronomic Sciences

E-mail: lkupe@ubt.edu.al

**ABSTRACT:** Medicinal plants are increasingly being used as an alternative to synthetic products, finding use not only in traditional medicine and pharmaceutical industry but also in the food and cosmetic industries due to their nutritional properties and bioactivity. Based on their economic, ecological and scientific value, they constitute one of the national natural assets of great importance. One of the widely spread plants in Albania is *Achillea millefolium*, a plant of the Asteraceae family with therapeutic properties. The health benefits of this plant's extracts result from a variety of secondary metabolites that include flavonoids, phenolic acids, terpenes, guaianolides, phytosterols, fatty acids, and organic acids. This study is focused on the evaluation of chemical components of *Achillea millefolium* essential oil using the hydro distillation method with gas chromatography, using flame ionization gas chromatograph. The plant material was collected in May-July 2023 in 4 different areas of Albania (Kukës, Tirana, Librazhd, Përmet). Obtained results showed that the essential oil of *Achillea millefolium* has a high content of secondary metabolites. The most abundant components are: alpha pinene (1.9-4.13%), beta-Pinene (6.8 – 12.1%), Cineole (7.68 -24,33 %), Camphor (2.64-4,23%), Borneol (19,62-20.72%), Azulenes (3.19–17,83%), Cineol (17.6– 24.33 %).

**Keywords:** *Achillea Millefolium*, Essential Oil, Chemical Components

#### 1. INTRODUCTION

Medicinal plants are increasingly being used as an alternative to synthetic products. These plants are used not only in traditional medicine and the pharmaceutical industry, but also in the food and cosmetic industries due to their nutritional properties and bioactivity. Due to their economic, ecological and scientific value, they constitute one of the national natural resources of great importance. One of the most widespread plants in Albania is *Achillea millefolium*, a plant of the Asteraceae family with therapeutic properties (Wolfgang et. al., 2003). *Achillea millefolium* was named after *Achilles*, the Greek mythological figure who used it to stop the bleeding wounds of his soldiers (Kowalchik C & Hylton WH, 1998). *Achillea millefolium* is found throughout Albania, from the northernmost to southernmost regions. This herbaceous plant has an unbranched stem that grows up to 80 cm tall and is characterized by its white, umbrella-shaped flowers and green to grey leaves. It is lightly aromatic with a bitter taste and blooms from June to November. *Achillea millefolium* is prevalent in meadows and mountainous areas, sometimes even in forests. It is found at elevations starting from 500-600m above sea level and can reach up to 2400 m above sea level in mountain peaks. The health benefits of this plant's extracts are due to a range of secondary metabolites, including flavonoids. Numerous studies have extensively documented flavones and 3-hydroxyflavones, which are frequently isolated compounds, along with sesquiterpene lactones. *Luteolin*, *apigenin* and *quercetin* are among the flavonoids. Phenolic acids, which are distinguished by the presence of derivatives such as *benzoic*, *caffeic*, *chlorogenic*, and *caffeoylquinic acid*. Additionally, *terpenes*, *guaianolides*, *phytosterols*, *fatty acids*, and *organic acids* are also present (Kowalchik & Hylton, 1987). The aerial parts of the plant are believed to aid in the treatment of gastrointestinal disorders by promoting proper bile flow. They can also stimulate blood circulation and may be used to alleviate high blood pressure. Additionally, a decoction of the whole plant is used to treat bleeding piles and kidney disorders. The plant has a mild stimulant effect and can be used to treat various allergic mucus problems such as hay fever. Fresh leaves may be chewed to

## Proceeding Book of ISESER 2023

alleviate acute toothache or used as a mouthwash to promote the healing of cuts in the mouth and for tooth cleaning purposes (Noureddini et. al., 2008). In folk medicine, *Achillea millefolium* is ingested as an herbal tea to treat gastrointestinal disorders, headaches, hepato-biliary disorders, and as an appetite enhancer. Additionally, it is topically applied as a lotion or ointment for skin inflammations, wounds, cuts and abrasions.

*Achillea millefolium* extracts exhibit promising antimicrobial and antioxidant properties, which make them valuable ingredients in pharmaceutical and cosmetic products. The exploration of the use of flavonoids found in *Achillea millefolium* L. (seed oil) for formulations like sunscreens is prevalent. Additionally, traditional utilization of plants for medicinal purposes or for enhancing beauty has become a foundation for countless research studies resulting in novel developments in cosmetics (Strzepek et. al., 2023). In recent years, numerous studies have been conducted in the field of nanotechnology utilising *Achillea millefolium* as a component of nanoparticles. The results have shown promising effects of *Achillea millefolium* formulations as a practical distribution system. The aerial parts of the plant are utilized for treating gastrointestinal disorders by supporting proper bile flow, stimulating blood circulation to alleviate high blood pressure, and treating kidney disorders and bleeding piles with decoctions. Additionally, the plant has a mild stimulant effect and can be used to treat various allergic mucus disorders like hay fever (Noureddini et. al., 2008).

For acute toothache, fresh leaves can be chewed or used as a mouthwash to promote the healing of cuts in the mouth and for dental hygiene. In traditional medicine, *Achillea millefolium* is ingested as an herbal infusion for the treatment of digestive problems, headaches, and liver and

bile disorders, as well as for stimulating the appetite (Kumar et. al., 2021). As a topical agent, it is utilized in the form of a lotion or ointment to alleviate skin inflammations, wounds, cuts, and abrasions.

*Achillea millefolium* extracts additionally exhibit potential antioxidant and antimicrobial properties, making them useful in various pharmaceutical and cosmetic formulations. The exploration of the potential use of flavonoids in *Achillea millefolium* L. (seed oil) for formulation into sunscreens is ongoing. Furthermore, the traditional application of plants for medicinal or cosmetic purposes has formed the foundation for extensive research studies and innovative developments in the cosmetic industry (Strzepek et. al., 2023). These green synthesised nanoparticles show potential for pharmaceutical and biomedical applications (Yousaf et; al., 2020). They exhibit considerable boosting of antibacterial and antioxidant properties whilst significantly enhancing therapeutic performance (Yousaf et; al., 2020). This study aims to evaluate the chemical composition of *Achillea millefolium* essential oil using the hydro distillation method and gas chromatography with a flame ionization detector. The plant material was collected from four different areas in Albania (Kukësi, Tirana, Librazhdi, and Përmeti) between May and July 2023.

## 2. MATERIAL AND METHODS

### ▪ Collection and prepare of plant material

The plant was collected between May and July 2023 in four distinct regions across Albania: Kukësi, Tirana, Librazhdi and Përmeti (Fig. 1).



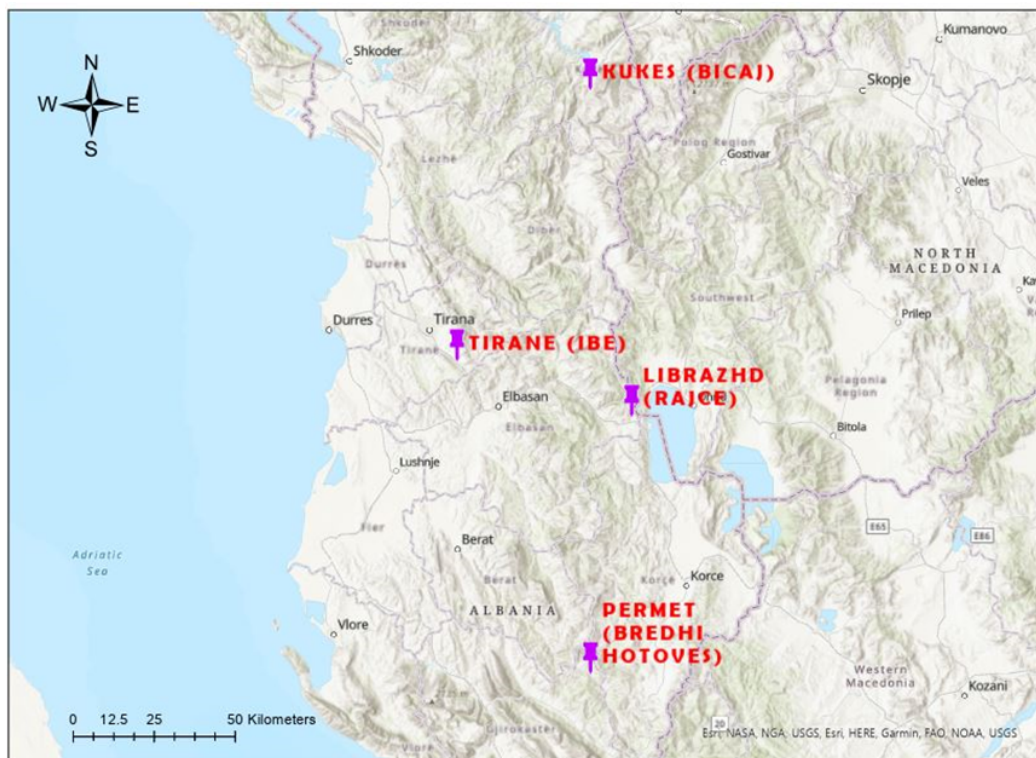

Figure 1: Map of sampling sites of *Achillea millefolium*

The sites are indicated in figure 1. To maintain the morphological and chemical properties, the *Achillea millefolium* specimens were air-dried. This herbaceous perennial plant has an upright growth habit and generates one to numerous stems reaching a height of 0.2–1 metre (8–40 inches), with a rhizomatous growth pattern. The leaves are evenly spread out throughout the stem, with the largest ones situated near the middle and bottom of it (Fig. 2).

The plant material was subsequently cut into small pieces. 50 g of the dried *Achillea millefolium* specimens were placed in a 250 ml flask. 150 ml of distilled water and 2 ml of toluene were then added to the flask to extract the essential oils from the *Achillea millefolium* specimens.



Figure 2: *Achillea millefolium*

**Proceeding Book of ISESER 2023**

▪ **Isolation of essential oil from *Achillea millefolium***

Technical abbreviations have been explained upon their first use. Plant material from 50 g of *Achillea millefolium* was distilled for 3 hours using a Clevenger-type apparatus, as recommended by the European Pharmacopoeia for 6 hours, resulting in the production of the essential oil. The oil, which was made into a 2 ml Toluene solution, was then dried using anhydrous sodium-sulphate and kept sealed in a dark glass vial at +4°C until injection into GC/FID. Gas chromatographic analyses were conducted using a Varian 450 GC instrument, which featured a flame ionisation detector and PTV detector. The PTV injector was maintained at a temperature of 260°C. A sample of *Achillea millefolium* essential oil, which had been diluted in Toluene, was injected in splitless mode at a volume of 1 µl. An FID temperature of 280°C was maintained. Nitrogen served as the carrier (flow rate: 1 ml/min), while the make-up gas flowed at a rate of 25 ml/min. The flame detector gases comprised hydrogen (30 ml/min) and air (300 ml/min). A VF-1ms capillary column (30 m x 0.33 mm x 0.25 µm) was employed to separate the compounds of *Achillea millefolium* essential oil. The oven temperature was programmed in the following way: an initial temperature of 40°C (maintained for two minutes) was raised to 150°C (with a gradient rate of 4°C/min), further raised to 280°C with a gradient rate of 10°C/min and kept at this temperature for two minutes.

**3. RESULTS AND DISCUSSIONS**

During the analysis of *Achillea millefolium* essential oil, it was observed that their chromatograms contained 40-50 compounds. After analysis, 18 main constituents were identified, (Tab. 1) which ranged in concentration from 89.57% (Tirana) to 96.1% (Kukësi).

**Table 1:** Displays the percentages of the 18 main constituents of *Achillea millefolium*.

Components of essential oil	Kukësi	Përmeti	Tirana	Librazhdi
<i>Alpha-Pinene</i>	2.53	4.13	2.73	1.9
<i>Camphene</i>	3.16	1.48	4.67	6.8
<i>Beta-Pinene</i>	2.96	4.98	2.26	1.1
<i>Limonene</i>	1.17	3.25	1.46	1.58
<i>Para-Cimen</i>	5.63	7.65	3.96	4.25
<i>Cineole</i>	17.68	16.32	24.33	23.46
<i>Gama-Terpinene</i>	5.56	6.53	3.69	2.24
<i>Alfa-Thujone</i>	1.75	5.28	0.81	0.3
<i>Beta-Thujone</i>	1.59	4.63	0.55	0.11
<i>Camphor</i>	3.73	4.23	2.64	1.87
<i>Borneol</i>	20.32	19.62	20.72	20.9
<i>Terpylen-4-ol</i>	0.99	0.56	1.52	1.81
<i>Alpha-Terpineol</i>	5.77	5.11	3.89	4.65
<i>Acetate-Terpinol</i>	0.62	0.18	1.89	1.65
<i>Acetate Bornil</i>	1.42	1.96	1.58	1.41
<i>Caryophyllene</i>	1.34	0.63	1.05	0.44
<i>Cadinene</i>	1.05	0.43	2.12	0.85
<i>Azulenes</i>	18.83	3.19	9.7	17.45
<b>Total</b>	96.1	90.16	89.57	92.77
<i>Total monoterpenes</i>	74.88	85.91	76.7	74.03

Proceeding Book of ISESER 2023

<i>Bicyclic monoterpenes</i>	5.49	9.11	4.99	3
<i>Monocyclic monoterpenes</i>	6.73	9.78	5.15	3.82
<i>Aliphatic monoterpenes</i>	3.16	1.48	4.67	6.8
<i>Oxygenated monoterpenes</i>	53.87	57.89	57.93	56.16
<i>Aromatic monoterpenes</i>	5.63	7.65	3.96	4.25
<i>Sesquiterpenes</i>	21.22	4.25	12.87	18.74

The chemical constituents of the sample were analysed, (Fig. 3) determining *Borneol* as the most prominent compound, ranging from 19.62% to 20.72%. *Cineole* came next, with percentages ranging from 16.32% to 24.33%, followed by *Azulenenes*, with values ranging from 3.19% to 18.83%. It is worth noting that technical term abbreviations used have been previously explained. Other compounds present but in lower percentages were *Para-Cimen*, *Camphene*, *Gama-terpinene*, *Camphor*, *alpha pinene*, *beta pinene*, and *alpha terpineol*, with percentages ranging from 1.1% to 6.8%.

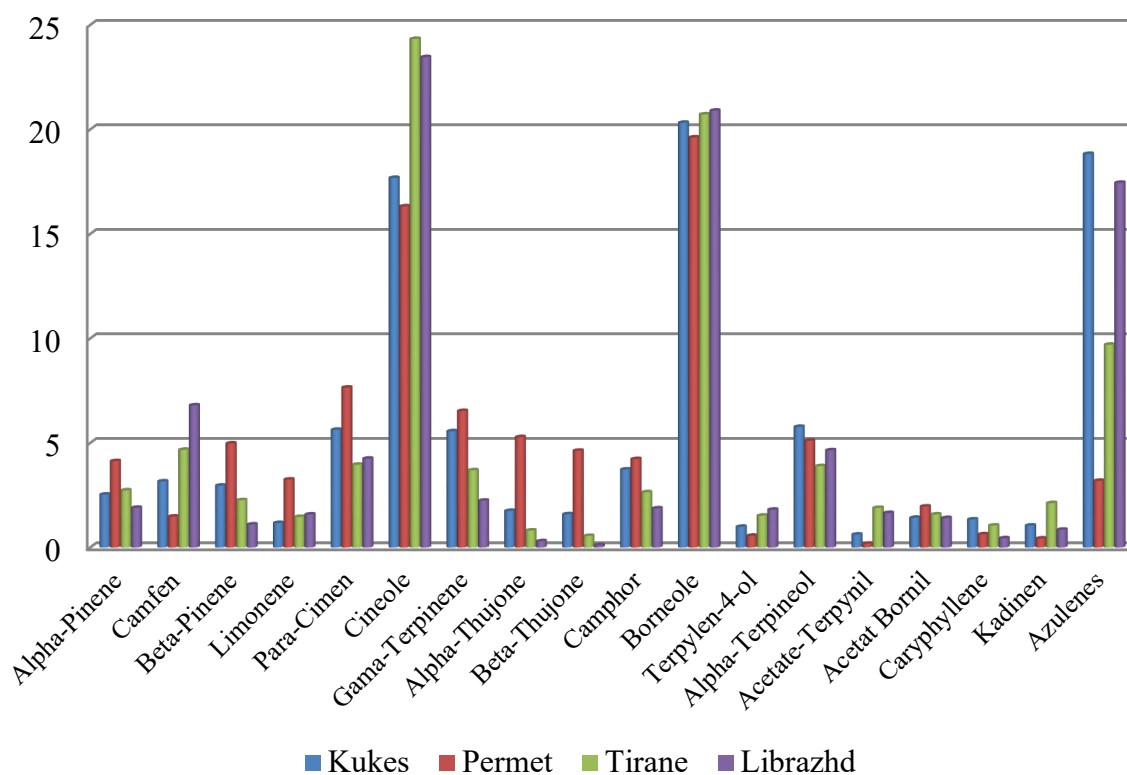

**Figure 3:** Chemical components of *Achillea millefolium* in four Albania sites.

Figure 4, demonstrates that monoterpenes comprise the largest group of terpenes (74.03%-85.91%). Within the group of monoterpenes, oxygenated terpenoids were the most abundant (*Cineole*, *alpha-Thujone*, *beta-Thujone*, *Camphor*, *Borneol*, *Terpylen-4-ol*, *alpha-Terpineol*, *Terpinol Acetate*, *Bornyl Acetate*), accounting for 53.87%-57.93% of the total. Sesquiterpenes, including *Caryophyllene*, *Azulenenes*, and *Cadinene*, were found to range from 4.25% to 21.22% in the oil extracted from *Achillea millefolium*. The composition of the oil is influenced by multiple factors, such as the time of plant harvesting, geographical location, and sample composition.

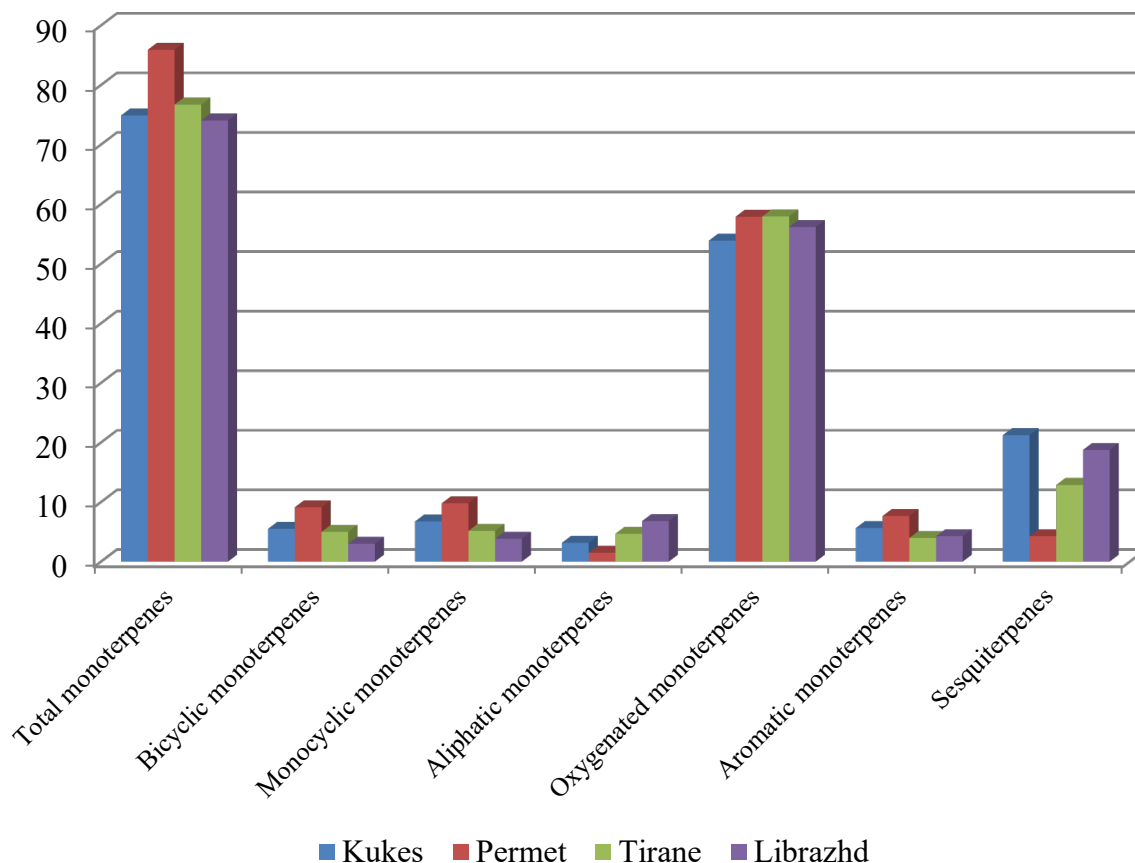

Figure 4: Terpenes content in *Achillea millefolium* in four Albanian sites.

#### 4. CONCLUSION

- The chromatograms of the essential oil from *Achillea millefolium* contained 40-50 components upon observation.
- The sample's chemical constituents were analysed, revealing borneol as the most noteworthy compound, with a percentage range of 19.62% to 20.72%. Cineole follows, with values ranging from 16.32% to 24.33%, succeeded by Azulenes with values ranging from 3.19% to 18.83%. Notably, technical term abbreviations have been defined beforehand.
- Additional compounds found in smaller amounts include para-cymene, camphene, gamma-terpinene, camphor, alpha-pinene, beta-pinene, and alpha-terpineol, with percentages ranging from 1.1% to 6.8%.

#### LITERATURE

- Candan F, Unlu M, Tepe B, Daferera D, Polissiou M, Sökmen A, Akpulat HA., 2021, Antioxidant and antimicrobial activity of the Çiğdem Aydın Acar. /Turkish Journal of Health Science and Life, 4(1), 40-45.
- Evans WC.11., 2002, Trease and Evans pharmacognosy, 15th ed. Edinburgh, WB Saunders.
- Kowalchik C & Hylton WH, 1998, Rodale's Illustrated Encyclopedia of Herbs, Eds, P.293, 367, 518. ISBN 978-0-87596-964-0.
- Kumar P, Shruthi R, Bindu I, Raghavendra P., 2021, Pharmacognosy, phytochemistry, and molecular studies of an important medicinal herb *Achillea millefolium* L. Ayu., 42(2): 93-102.
- Lakshmi T, Geetha RV, Roy A, Kumar SA., 2011, Yarrow (*Achillea millefolium* L.), A herbal medicinal plant with broad therapeutic use –A review. Int J Pharm Sci Rev Res., 9:136–41.
- Mohammad Hosseini, Majid, Satyajit D. Sarker, and Abolfazl Akbarzadeh., 2017, "Chemical composition of the essential oils and extracts of *Achillea* species and their biological activities: A review." Journal of ethnopharmacology, 199, 257-315.

**Proceeding Book of ISESER 2023**

- Noureddini M., Rasta V.-R., 2008, Analgesic Effect of aqueous extract of *Achillea millefolium* L. on rat's formalin test *Pharmacology online*, 3 (659-664).
- Saeidnia S, Gohari A, Mokhber-Dezfuli N, Kiuchi F., 2011, A review on phytochemistry and medicinal properties of the genus *Achillea*. *Daru.*, 19(3):173-86.
- Si XT, Zhang ML, Shi QW, Kiyota H., 2006, Chemical Constituents of the Plants in the Genus *Achillea*. *Chem Biodiversity*, 3:1163–1180.
- Strzępek-Gomółka M, Gawel-Beben K, Kukula-Koch W. 2021, *Achillea* Species as Sources of Active Phytochemicals for Dermatological and Cosmetic Applications. *Oxid Med Cell Longev.*, doi: 10.1155/2021/6643827. PMID: 33833853; PMCID: PMC8018854.
- Wolfgang Kathe, Susanne Honnef & Andreas Heym, 2003, Medicinal and Aromatic Plants in Albania, Bosnia-Herzegovina, Bulgaria, Croatia and Romania. A study of the collection of and trade in medicinal and aromatic plants (MAPs), relevant legislation and the potential of MAP use for financing nature conservation and protected areas” WWF Deutschland / TRAFFIC Europe-Germany. BfN, 2003, 200.
- Yousaf H, Mehmood A, Ahmad KS, Raffi M. Green synthesis of silver nanoparticles and their applications as an alternative antibacterial and antioxidant agent. *Mater Sci Eng C Mater Biol Appl.*, 2020 Jul; 112:110901. doi: 10.1016/j.msec.2020.110901; PMID: 32409057.

**P 4. BTEX MEASUREMENT RESULTS OF KONYA**

Feray YÜMÜN<sup>1\*</sup>, İlknur KARAGÖNEN<sup>1</sup>, Memet Ali ŞANLI<sup>1</sup>, Akif BÜYÜKMUMCU<sup>1</sup>

<sup>1</sup>*South Central Anatolia Clean Air Directorate, 42080 Konya, Turkey*

E-mail: *feray.yumun@csb.gov.tr, ilknur.karagonen@csb.gov.tr, memetali.sanli@csb.gov.tr, akif.buyukmumcu@csb.gov.tr*

**ABSTRACT:** In this study carried out in the analytical laboratory of the Southern Central Anatolia Clean Air Center in Konya, the parameters of Benzene, Toluene, Ethylbenzene and o,p,m-Xylene (BTEX), which are volatile organic pollutants, were measured by the active sampling method. In this study conducted with the active sampling method, 2 traffic, 2 industrial and 1 background-related pollution were measured in 2022. Samples were taken from 5 different measurement points: Konya Beşyol traffic, Paşam traffic, OSB industry, İNNOPARK industry, Sarayönü background and studied for 7 days each. It was observed that benzene concentrations resulting from traffic were slightly below the limit values as a result of BTEX sampling.

*Keywords: Konya, Air Pollution, Volatile Organic Compounds, Environmental Engineering, Chemical Engineering*

**P 5. CORN PRODUCTION AND EXPORT OPPORTUNITIES IN UKRAINE DURING  
TIMES OF WAR**

Olena Demyanyuk<sup>1</sup>, Lyudmyla Symochko<sup>1,2,3\*</sup>, Oleksandr Poltava<sup>1</sup>, Olena Naumovska<sup>4</sup>

<sup>1</sup>*Institute of Agroecology and Environmental Management, Kyiv, Ukraine*

<sup>2</sup>*Uzhhorod National University, Uzhhorod, Ukraine;*

<sup>3</sup>*University of Coimbra, Coimbra, Portugal;*

<sup>4</sup>*National University of Life and Environmental Sciences of Ukraine, Kyiv, Ukraine*

E-mail: [lyudmilassem@gmail.com](mailto:lyudmilassem@gmail.com)

**ABSTRACT:** Corn, as a cereal crop, maintains its leading position in the global agri-food market thanks to its versatile uses. Ukraine, benefiting from favorable soil and climatic conditions, has been a significant corn exporter to the global market and held the sixth position among leading countries until 2022. It produced approximately 35.5 million metric tons, accounting for 3.2% of the world's total corn production. However, in 2022, due to active hostilities, disruptions in logistics, supply chain issues for fertilizers, plant protection products, seeds, and fuel for agricultural machinery, as well as landmine contamination and other factors, the corn cultivation area decreased by 22%. Consequently, gross production decreased by 37.8% compared to the previous year, reaching approximately 27 million tons. This shift in production caused Ukraine to slip two positions in the world rankings of corn-producing and exporting countries. In the unstable conditions of 2023, marked by ongoing warfare, blockades of Ukrainian ports, and declining prices in the domestic market, the corn cultivation area has further decreased to 3.4 million hectares. In the 2021/2022 MY, Ukraine's main exports of corn were directed to China, Spain, Romania, Turkey, and Egypt, with estimated values of \$1,449 million, \$745 million, \$598 million, \$414 million, and \$412 million, respectively. It is essential to consider that substantial areas of agricultural land may temporarily become unsuitable for their intended use due to environmental issues stemming from the conflict. Therefore, Russia's extensive invasion of Ukraine has had a detrimental impact on all sectors of the economy, including agriculture. Occupied territories, landmines, and other factors have led to a reduction in corn cultivation areas, negatively affecting Ukraine's export potential and potentially impacting global food security.

**Keywords:** *Food security, War in Ukraine, Global Maize Production*

**P 6. REMOVAL OF As(V) FROM WATER BY USING PRE-COATED RED MUD  
MEMBRANES**

Fuat Aslan<sup>1</sup>, Omer Kazak<sup>1,2</sup>, Hasan Kotan<sup>3</sup>, Haluk Bingol<sup>1,4</sup>, Ali Tor<sup>1,2,\*</sup>

<sup>1</sup>*Science and Technology Research and Application Center (BITAM), Necmettin Erbakan University, Konya, Turkey*

<sup>2</sup>*Department of Environmental Engineering, Necmettin Erbakan University, Konya, Turkey*

<sup>3</sup>*Department of Metallurgical and Materials Engineering, Bursa Technical University, Bursa, Turkey.*

<sup>4</sup>*Department of Fundamental Science, Necmettin Erbakan University, Konya, Turkey*

E-mail: *fuataslan211@gmail.com (Fuat Aslan), okazak@erbakan.edu.tr (Omer Kazak), hasan.kotan@btu.edu.tr (Hasan Kotan), halukbingol@gmail.com (Haluk Bingol), ali.alitor@gmail.com (Ali Tor)*

**ABSTRACT:** The red mud pre-coated membranes were prepared through a simple deposition on the cellulose filter paper in-line filter holder by using a syringe. The red mud samples ball-milled for different times were characterized by using the measurements of surface area, pore volume and particle size distribution and XRD technique. The surface and cross-section of the prepared membrane were also monitored by FE-SEM technique. The experiments performed on 20 µg/L of As(V) solution indicated that the best membrane performance was obtained by using 5 mL of suspension (0.1 g red mud/ 50 mL water) prepared with 10 h of ball-milled red mud sample at solution pH of 3. The results also indicated that the flow rate had no effect on the removal performance of the membrane. Application to the fortified real water sample also reflected that the membrane was able to reduce As(V) concentration below the limit value set by WHO (10 µg/L) with no matrix effect of real sample. Overall results indicated that the red mud can be successfully used in the preparation of pre-coated membranes for the removal of pollutants from water in continuous adsorption system.

**Keywords:** *Pre-Coated Membrane, Red Mud, Arsenate, Water Treatment*

*This work was supported by the Scientific Research Projects of Necmettin Erbakan University (201219003).*



**P 7. ZERO WASTE INFORMATION SYSTEM (KOSABS)**

Serhat Sargin<sup>1</sup> Meryem Ceylan<sup>1</sup>, Emin Tatlısu<sup>1</sup>

<sup>1</sup>*Konya Municipality, Konya, Türkiye*

E-mail: *sifiratik@konya.bel.tr*

**ABSTRACT:** By recording the type and amount of recyclable waste (mixed, paper, plastic, glass, metal, waste vegetable oil, waste medicine, etc.) collected separately at the source in all 31 districts of Konya, starting from the central districts, in the system at the source; To see exactly how much waste is produced at the waste point, street, region, neighborhood, district and province and to analyze the data. First of all, our website *sifiratik.konya.bel.tr* was launched in order to increase citizens access to recyclable waste points in the central districts and to inform them about zero waste, and recyclable waste points were added to the map environment and published in coordination with the central district municipalities. We started working with Karatay Municipality, one of the central districts of Konya, and all points where recyclable waste is received within the district borders have been entered into the system and data has started to be recorded. It is planned to start working with other central districts as of 2023.

**Keywords:** *Zero Waste Management System*